

ETSI TS 138 174 V17.7.0 (2024-05)



**5G;**  
**NR; Integrated Access and Backhaul (IAB)**  
**radio transmission and reception**  
**(3GPP TS 38.174 version 17.7.0 Release 17)**



---

**Reference**

RTS/TSGR-0438174vh70

---

**Keywords**

5G

**ETSI**

---

650 Route des Lucioles  
F-06921 Sophia Antipolis Cedex - FRANCE

Tel.: +33 4 92 94 42 00 Fax: +33 4 93 65 47 16

Siret N° 348 623 562 00017 - APE 7112B  
Association à but non lucratif enregistrée à la  
Sous-Préfecture de Grasse (06) N° w061004871

---

**Important notice**

The present document can be downloaded from:

<https://www.etsi.org/standards-search>

The present document may be made available in electronic versions and/or in print. The content of any electronic and/or print versions of the present document shall not be modified without the prior written authorization of ETSI. In case of any existing or perceived difference in contents between such versions and/or in print, the prevailing version of an ETSI deliverable is the one made publicly available in PDF format at [www.etsi.org/deliver](http://www.etsi.org/deliver).

Users of the present document should be aware that the document may be subject to revision or change of status.

Information on the current status of this and other ETSI documents is available at

<https://portal.etsi.org/TB/ETSIDeliverableStatus.aspx>

If you find errors in the present document, please send your comment to one of the following services:

<https://portal.etsi.org/People/CommitteeSupportStaff.aspx>

If you find a security vulnerability in the present document, please report it through our  
Coordinated Vulnerability Disclosure Program:

<https://www.etsi.org/standards/coordinated-vulnerability-disclosure>

---

**Notice of disclaimer & limitation of liability**

The information provided in the present deliverable is directed solely to professionals who have the appropriate degree of experience to understand and interpret its content in accordance with generally accepted engineering or other professional standard and applicable regulations.

No recommendation as to products and services or vendors is made or should be implied.

No representation or warranty is made that this deliverable is technically accurate or sufficient or conforms to any law and/or governmental rule and/or regulation and further, no representation or warranty is made of merchantability or fitness for any particular purpose or against infringement of intellectual property rights.

In no event shall ETSI be held liable for loss of profits or any other incidental or consequential damages.

Any software contained in this deliverable is provided "AS IS" with no warranties, express or implied, including but not limited to, the warranties of merchantability, fitness for a particular purpose and non-infringement of intellectual property rights and ETSI shall not be held liable in any event for any damages whatsoever (including, without limitation, damages for loss of profits, business interruption, loss of information, or any other pecuniary loss) arising out of or related to the use of or inability to use the software.

---

**Copyright Notification**

No part may be reproduced or utilized in any form or by any means, electronic or mechanical, including photocopying and microfilm except as authorized by written permission of ETSI.

The content of the PDF version shall not be modified without the written authorization of ETSI.

The copyright and the foregoing restriction extend to reproduction in all media.

© ETSI 2024.  
All rights reserved.

---

# Intellectual Property Rights

## Essential patents

IPRs essential or potentially essential to normative deliverables may have been declared to ETSI. The declarations pertaining to these essential IPRs, if any, are publicly available for **ETSI members and non-members**, and can be found in ETSI SR 000 314: "*Intellectual Property Rights (IPRs); Essential, or potentially Essential, IPRs notified to ETSI in respect of ETSI standards*", which is available from the ETSI Secretariat. Latest updates are available on the ETSI Web server (<https://ipr.etsi.org/>).

Pursuant to the ETSI Directives including the ETSI IPR Policy, no investigation regarding the essentiality of IPRs, including IPR searches, has been carried out by ETSI. No guarantee can be given as to the existence of other IPRs not referenced in ETSI SR 000 314 (or the updates on the ETSI Web server) which are, or may be, or may become, essential to the present document.

## Trademarks

The present document may include trademarks and/or tradenames which are asserted and/or registered by their owners. ETSI claims no ownership of these except for any which are indicated as being the property of ETSI, and conveys no right to use or reproduce any trademark and/or tradename. Mention of those trademarks in the present document does not constitute an endorsement by ETSI of products, services or organizations associated with those trademarks.

**DECT™**, **PLUGTESTS™**, **UMTS™** and the ETSI logo are trademarks of ETSI registered for the benefit of its Members. **3GPP™** and **LTE™** are trademarks of ETSI registered for the benefit of its Members and of the 3GPP Organizational Partners. **oneM2M™** logo is a trademark of ETSI registered for the benefit of its Members and of the oneM2M Partners. **GSM®** and the GSM logo are trademarks registered and owned by the GSM Association.

---

# Legal Notice

This Technical Specification (TS) has been produced by ETSI 3rd Generation Partnership Project (3GPP).

The present document may refer to technical specifications or reports using their 3GPP identities. These shall be interpreted as being references to the corresponding ETSI deliverables.

The cross reference between 3GPP and ETSI identities can be found under <https://webapp.etsi.org/key/queryform.asp>.

---

# Modal verbs terminology

In the present document "**shall**", "**shall not**", "**should**", "**should not**", "**may**", "**need not**", "**will**", "**will not**", "**can**" and "**cannot**" are to be interpreted as described in clause 3.2 of the [ETSI Drafting Rules](#) (Verbal forms for the expression of provisions).

"**must**" and "**must not**" are **NOT** allowed in ETSI deliverables except when used in direct citation.

# Contents

Intellectual Property Rights .....	2
Legal Notice .....	2
Modal verbs terminology.....	2
Foreword.....	15
1 Scope .....	17
2 References .....	17
3 Definitions, symbols and abbreviations .....	18
3.1 Definitions .....	18
3.2 Symbols.....	22
3.3 Abbreviations .....	24
4 General .....	26
4.1 Relationship with other core specifications.....	26
4.2 Relationship between minimum requirements and test requirements .....	26
4.3 Conducted and radiated requirement reference points .....	26
4.3.2 IAB type 1-H .....	27
4.3.3 IAB type 1-O and IAB type 2-O.....	27
4.4 IAB classes.....	28
4.4.1 IAB-DU classes .....	28
4.4.2 IAB-MT classes .....	28
4.5 Regional requirements.....	29
4.6 Applicability of requirements.....	29
4.7 Applicability of RRM requirements in this specification.....	31
4.7.1 Applicability of signalling characteristics related RRM requirements .....	31
4.8 Requirements for contiguous and non-contiguous spectrum.....	32
4.9 Requirements for IAB-DU and IAB-MT capable of multi-band operation.....	32
4.10 OTA co-location with other base stations .....	33
4.11 Requirements for IAB-DU and IAB-MT capable of simultaneous operation .....	34
5 Operating bands and channel arrangement.....	35
5.1 General .....	35
5.2 Operating bands.....	35
5.3 Channel bandwidth.....	35
5.3.1 General.....	35
5.3.2 Transmission bandwidth configuration.....	36
5.3.3 Minimum guardband and transmission bandwidth configuration.....	36
5.3.4 RB alignment.....	37
5.3.5 IAB-DU and IAB-MT channel bandwidth per operating band.....	37
5.3A IAB-DU and IAB-MT channel bandwidth for CA.....	37
5.4 Channel arrangement.....	37
5.4.1 Channel spacing.....	37
5.4.2 Channel raster .....	37
5.4.2.1 NR-ARFCN and channel raster.....	37
5.4.2.2 Channel raster to resource element mapping.....	37
5.4.2.3 Channel raster entries for each <i>operating band</i> .....	38
5.4.3 Synchronization raster .....	38
5.4.3.1 Synchronization raster and numbering.....	38
5.4.3.2 Synchronization raster to synchronization block resource element mapping.....	38
5.4.3.3 Synchronization raster entries for each operating band.....	38
6 Conducted transmitter characteristics .....	38
6.1 General .....	38
6.2 IAB output power.....	39
6.2.1 General.....	39
6.2.2 Minimum requirement for IAB type 1-H.....	39

6.2.3	Additional requirements (regional).....	39
6.3	Output power dynamics.....	39
6.3.1	IAB-DU Output Power Dynamics .....	39
6.3.1.1	General .....	39
6.3.1.2	RE power control dynamic range.....	40
6.3.1.2.1	General .....	40
6.3.1.2.2	Minimum requirement for <i>IAB-DU type 1-H</i> .....	40
6.3.1.3	Total power dynamic range.....	40
6.3.1.3.1	General .....	40
6.3.1.3.2	Minimum requirement for <i>IAB-DU type 1-H</i> .....	40
6.3.2	IAB-MT Output Power Dynamics.....	40
6.3.2.1	Total power dynamic range.....	40
6.3.2.1.1	General .....	40
6.3.2.1.2	Minimum requirement for <i>IAB-MT type 1-H</i> .....	40
6.3.3	Power control.....	41
6.3.3.1	Relative power tolerance for local area IAB-MT type 1-H.....	41
6.3.3.2	Aggregate power tolerance for local area IAB-MT type 1-H.....	41
6.4	Transmit ON/OFF power .....	41
6.4.1	Transmitter OFF power .....	41
6.4.1.1	General .....	41
6.4.1.3	Minimum requirement for <i>IAB-DU type 1-H</i> .....	42
6.4.1.4	Minimum requirement for <i>IAB-MT type 1-H</i> .....	42
6.4.2	Transmitter transient period.....	42
6.4.2.1	General .....	42
6.4.2.2	Minimum requirement for IAB-DU type 1-H.....	42
6.4.2.3	Minimum requirement for IAB-MT type 1-H.....	42
6.5	Transmitted signal quality .....	43
6.5.1	Frequency error.....	43
6.5.1.1	IAB-DU frequency error .....	43
6.5.1.2	IAB-MT frequency error.....	43
6.5.2	Modulation quality.....	43
6.5.2.1	IAB-DU modulation quality.....	43
6.5.2.2	IAB-MT modulation quality .....	43
6.5.2.2.1	General .....	43
6.5.2.2.2	Minimum requirements for IAB-MT type 1-H.....	43
6.5.2.2.3	EVM frame structure for measurement .....	44
6.5.3	Time alignment error .....	44
6.5.3.1	IAB-DU time alignment error.....	44
6.5.4	Timing error between IAB-DU and IAB-MT of the same IAB-Node.....	44
6.6	Unwanted emissions.....	44
6.6.1	General.....	44
6.6.2	Occupied bandwidth .....	45
6.6.2.1	General .....	45
6.6.2.2	Minimum requirement for <i>IAB-DU type 1-H</i> .....	45
6.6.2.3	Minimum requirement for <i>IAB-MT type 1-H</i> .....	45
6.6.3	Adjacent Channel Leakage Power Ratio .....	45
6.6.3.1	General .....	45
6.6.3.2	Limits and <i>Basic limits</i> .....	45
6.6.3.3	Minimum requirement for <i>IAB-DU type 1-H</i> and <i>IAB-MT type 1-H</i> .....	48
6.6.4	Operating band unwanted emissions .....	49
6.6.4.1	General .....	49
6.6.4.2	<i>Basic limits</i> .....	51
6.6.4.2.1	<i>Basic limits</i> for Wide Area IAB-DU and Wide Area IAB-MT (Category A) .....	51
6.6.4.2.2	<i>Basic limits</i> for Wide Area IAB-DU and Wide Area IAB-MT (Category B) .....	51
6.6.4.2.2.1	Category B requirements .....	51
6.6.4.2.3	<i>Basic limits</i> for Medium Range IAB-DU (Category A and B).....	52
6.6.4.2.4	<i>Basic limits</i> for Local Area IAB-DU and Local Area IAB-MT (Category A and B) .....	53
6.6.4.2.5	<i>Basic limits</i> for additional requirements.....	53
6.6.4.2.5.1	Limits in FCC Title 47.....	53
6.6.4.3	Minimum requirements for <i>IAB-DU type 1-H</i> and <i>IAB-MT type 1-H</i> .....	53
6.6.5	Transmitter spurious emissions.....	54
6.6.5.1	General .....	54

6.6.5.2	Basic limits.....	55
6.6.5.2.1	General transmitter spurious emissions requirements .....	55
6.6.5.2.2	Additional spurious emissions requirements .....	55
6.6.5.2.3	Co-location with base stations and IAB-Nodes .....	62
6.6.5.3	Minimum requirements for <i>IAB-DU</i> and <i>IAB-MT type 1-H</i> .....	67
6.7	Transmitter intermodulation.....	67
6.7.1	General.....	67
6.7.2	Minimum requirements for <i>IAB-DU type 1-H</i> and <i>IAB-MT type 1-H</i> .....	68
6.7.2.1	Co-location minimum requirements.....	68
6.7.2.2	Intra-system minimum requirements.....	68
7	Conducted receiver characteristics.....	69
7.1	General .....	69
7.2	Reference sensitivity level.....	69
7.2.1	IAB-DU reference sensitivity level .....	69
7.2.1.1	General .....	69
7.2.1.2	Minimum requirements for <i>IAB-DU type 1-H</i> .....	70
7.2.2	IAB-MT reference sensitivity level .....	70
	<b>Table 7.2.2-2: Void</b> .....	70
7.2.2.1	General .....	70
7.2.2.2	Minimum requirements for <i>IAB-MT type 1-H</i> .....	70
7.3	Dynamic range .....	71
7.3.1	IAB-DU dynamic range.....	71
7.3.1.1	General .....	71
7.3.1.2	Minimum requirement for <i>IAB-DU type 1-H</i> .....	71
7.4	In-band selectivity and blocking .....	71
7.4.1	Adjacent Channel Selectivity (ACS) .....	71
7.4.1.1	General .....	71
7.4.1.2	Minimum requirement for <i>IAB-DU type 1-H</i> .....	72
7.4.1.3	Minimum requirement for <i>IAB-MT type 1-H</i> .....	72
7.4.2	In-band blocking.....	73
7.4.2.1	General .....	73
7.4.2.2	Minimum requirement for <i>IAB-DU type 1-H</i> .....	73
7.4.2.3	Minimum requirement for <i>IAB-MT type 1-H</i> .....	73
7.5	Out-of-band blocking .....	75
7.5.1	General.....	75
7.5.2	Void .....	75
7.5.3	Minimum requirement for <i>IAB-DU type 1-H</i> .....	76
7.5.4	Co-location minimum requirements for <i>IAB-DU type 1-H</i> .....	76
7.5.5	Minimum requirement for <i>IAB-MT type 1-H</i> .....	76
7.5.6	Co-location minimum requirements for <i>IAB-MT type 1-H</i> .....	76
7.6	Receiver spurious emissions.....	77
7.6.1	General.....	77
7.6.2	IAB-DU receiver spurious emissions .....	77
7.6.2.1	Basic limits.....	77
7.6.2.2	Minimum requirement for <i>IAB-DU type 1-H</i> .....	78
7.6.3	IAB-MT receiver spurious emissions .....	78
7.6.3.1	Basic limits.....	78
7.6.3.2	Minimum requirement for <i>IAB-MT type 1-H</i> .....	79
7.7	Receiver intermodulation .....	79
7.7.1	General.....	79
7.7.2	Minimum requirement for <i>IAB-DU type 1-H</i> .....	79
7.7.3	Minimum requirement for <i>IAB-MT type 1-H</i> .....	80
7.8	In-channel selectivity .....	80
7.8.1	General.....	80
7.8.2	Minimum requirement for <i>IAB-DU type 1-H</i> .....	80
8	Conducted performance requirements.....	80
8.1	IAB-DU performance requirements .....	80
8.1.1	General.....	80
8.1.2	Performance requirements for PUSCH.....	81
8.1.2.1	Requirements for PUSCH with transform precoding disabled .....	81

8.1.2.1.1	General .....	81
8.1.2.1.	Minimum requirements .....	81
8.1.2.2	Requirements for PUSCH with transform precoding enabled .....	88
8.1.2.2.1	General .....	88
8.1.2.2.2	Minimum requirements .....	89
8.1.2.3	Requirements for UCI multiplexed on PUSCH .....	90
8.1.2.3.1	General .....	90
8.1.2.3.2	Minimum requirements .....	91
8.1.3	Performance requirements for PUCCH .....	92
8.1.3.1	DTX to ACK probability .....	92
8.1.3.1.1	General .....	92
8.1.3.1.2	Minimum requirement.....	93
8.1.3.2	Performance requirements for PUCCH format 0 .....	93
8.1.3.2.1	General .....	93
8.1.3.2.2	Minimum requirement.....	93
8.1.3.3	Performance requirements for PUCCH format 1 .....	94
8.1.3.3.1	NACK to ACK requirements .....	94
8.1.3.3.2	ACK missed detection requirements .....	95
8.1.3.4	Performance requirements for PUCCH format 2 .....	96
8.1.3.4.1	NACK to ACK requirements .....	96
8.1.3.4.2	UCI BLER performance requirements .....	97
8.1.3.5	Performance requirements for PUCCH format 3 .....	98
8.1.3.5.1	General .....	98
8.1.3.5.2	Minimum requirements .....	99
8.1.3.6	Performance requirements for PUCCH format 4 .....	99
8.1.3.6.1	General .....	99
8.1.3.6.2	Minimum requirement.....	100
8.1.3.7	Performance requirements for multi-slot PUCCH .....	101
8.1.3.7.1	General .....	101
8.1.3.7.2	Performance requirements for multi-slot PUCCH format 1 .....	101
8.1.4	Performance requirements for PRACH .....	102
8.1.4.1	PRACH false alarm probability .....	102
8.1.4.1.1	General .....	102
8.1.4.1.2	Minimum requirement.....	103
8.1.4.2	PRACH detection requirements.....	103
8.1.4.2.1	General .....	103
8.1.4.2.2	Minimum requirements for normal mode.....	103
8.2	IAB-MT requirements.....	104
8.2.1	General.....	104
8.2.2	Demodulation performance requirements.....	104
8.2.2.1	Performance requirements for PDSCH .....	104
8.2.2.1.1	General .....	104
8.2.2.1.2	Minimum requirements .....	105
8.2.2.2	Performance requirements for PDCCH.....	106
8.2.2.2.1	General .....	106
8.2.2.2.2	Minimum requirements .....	106
8.2.3	CSI reporting requirements.....	107
8.2.3.1	General .....	107
8.2.3.1.1	Common test parameters .....	107
8.2.3.2	Reporting of Channel Quality Indicator (CQI) .....	109
8.2.3.2.1	General .....	109
8.2.3.2.2	Minimum requirements .....	109
8.2.3.3	Reporting of Precoding Matrix Indicator (PMI) .....	110
8.2.3.3.1	General .....	110
8.2.3.3.2	Minimum requirements .....	112
8.2.3.4	Reporting of Rank Indicator (RI).....	112
8.2.3.4.1	General .....	112
8.2.3.4.2	Minimum requirements .....	113
9	Radiated transmitter characteristics.....	114
9.1	General .....	114
9.2	Radiated transmit power.....	114

9.2.1	General.....	114
9.2.2	Minimum requirement for IAB-DU type 1-H, IAB-DU type 1-O, IAB-MT type 1-H and IAB-MT type 1-O .....	115
9.2.3	Minimum requirement for IAB-DU type 2-O and IAB-MT type 2-O.....	115
9.2.4	Configured radiated output power .....	115
9.2.4.1	IAB-MT configured output power for IAB-MT type 1-H, 1-O and 2-O .....	115
9.3	OTA IAB output power.....	116
9.3.1	General.....	116
9.3.2	Minimum requirement for IAB-DU type 1-O and IAB-MT type 1-O.....	116
9.3.3	Minimum requirement for IAB type 2-O.....	116
9.4	OTA output power dynamics .....	116
9.4.1	IAB-DU OTA Output Power Dynamics.....	116
9.4.1.1	General .....	116
9.4.1.2	OTA RE power control dynamic range.....	117
9.4.1.2.1	General .....	117
9.4.1.2.2	Minimum requirement for <i>IAB-DU type 1-O</i> .....	117
9.4.1.3	OTA total power dynamic range.....	117
9.4.1.3.1	General .....	117
9.4.1.3.2	Minimum requirement for <i>IAB-DU type 1-O</i> .....	117
9.4.1.3.3	Minimum requirement for <i>IAB-DU type 2-O</i> .....	117
9.4.2	IAB-MT OTA Output Power Dynamics.....	117
9.4.2.1	OTA total power dynamic range.....	117
9.4.2.1.1	General .....	117
9.4.2.1.2	Minimum requirement for IAB-MT type 1-O .....	118
9.4.2.1.3	Minimum requirement for IAB-MT type 2-O .....	118
9.4.3	Power control.....	118
9.4.3.1	Power control for local area IAB-MT type 1-O .....	118
9.4.3.1.1	Relative EIRP tolerance for local area IAB-MT type 1-O .....	118
9.4.3.1.2	Aggregate EIRP tolerance for local area IAB-MT type 1-O .....	118
9.4.3.2	Power control for local area IAB-MT type 2-O .....	119
9.4.3.2.1	Relative EIRP tolerance for local area IAB-MT type 2-O .....	119
9.4.3.2.2	Aggregate EIRP tolerance for local area IAB-MT type 2-O .....	119
9.5	OTA transmit ON/OFF power.....	119
9.5.1	General.....	119
9.5.2	OTA transmitter OFF power.....	119
9.5.2.1	General .....	119
9.5.2.2	Minimum requirement for IAB-DU type 1-O .....	120
9.5.2.3	Minimum requirement for IAB-DU type 2-O .....	120
9.5.2.4	Minimum requirement for IAB-MT type 1-O.....	120
9.5.2.5	Minimum requirement for IAB-MT type 2-O.....	120
9.5.3	OTA transient period .....	120
9.5.3.1	General .....	120
9.5.3.2	Minimum requirement for IAB-DU type 1-O .....	120
9.5.3.3	Minimum requirement for IAB-DU type 2-O .....	120
9.5.3.4	Minimum requirement for IAB-MT type 1-O.....	120
9.5.3.5	Minimum requirement for IAB-MT type 2-O.....	120
9.6	OTA transmitted signal quality .....	121
9.6.1	OTA frequency error .....	121
9.6.1.1	IAB-DU OTA frequency error.....	121
9.6.1.2	IAB-MT OTA frequency error.....	121
9.6.1.2.1	General .....	121
9.6.1.2.2	Minimum requirement for IAB-MT type 1-O .....	121
9.6.1.2.3	Minimum requirement for IAB-MT type 2-O .....	121
9.6.2	OTA modulation quality .....	121
9.6.2.1	IAB-DU OTA modulation quality .....	121
9.6.2.2	IAB-MT OTA modulation quality .....	121
9.6.2.2.1	General .....	121
9.6.2.2.2	Minimum requirement for IAB-MT type 1-O .....	121
9.6.2.2.3	Minimum requirement for IAB-MT type 2-O .....	122
9.6.2.2.4	EVM frame structure for measurement .....	122
9.6.3	OTA time alignment error .....	122
9.6.3.1	IAB-DU OTA time alignment error.....	122



9.6.4	Timing error between IAB-DU and IAB-MT of the same IAB-Node .....	122
9.7	OTA unwanted emissions .....	122
9.7.1	General .....	122
9.7.2	OTA occupied bandwidth .....	123
9.7.2.1	General .....	123
9.7.2.2	Minimum requirement for <i>IAB-DU type 1-O</i> and <i>IAB-DU type 2-O</i> .....	123
9.7.2.3	Minimum requirement for <i>IAB-MT type 1-O</i> and <i>IAB-MT type 2-O</i> .....	123
9.7.3	OTA Adjacent Channel Leakage Power Ratio (ACLR) .....	123
9.7.3.1	General .....	123
9.7.3.2	Minimum requirement for <i>IAB-DU type 1-O</i> and <i>IAB-MT type 1-O</i> .....	124
9.7.3.3	Minimum requirement for <i>IAB-DU type 2-O</i> and <i>Wide Area IAB-MT type 2-O</i> .....	124
9.7.3.4	Minimum requirement for <i>Local Area IAB-MT type 2-O</i> .....	126
9.7.4	OTA operating band unwanted emissions .....	128
9.7.4.1	General .....	128
9.7.4.2	Minimum requirement for <i>IAB-DU type 1-O</i> .....	128
9.7.4.3	Minimum requirement for <i>IAB-MT type 1-O</i> .....	128
9.7.4.4	Additional requirements .....	128
9.7.4.4.1	Limits in FCC Title 47 .....	128
9.7.4.5	Minimum requirement for <i>IAB-DU type 2-O</i> and <i>IAB-MT type 2-O</i> .....	129
9.7.4.5.1	General .....	129
9.7.4.5.2	OTA operating band unwanted emission limits (Category A) .....	130
9.7.4.5.3	OTA operating band unwanted emission limits (Category B) .....	130
9.7.4.5.4	Additional OTA operating band unwanted emission requirements .....	131
9.7.5	OTA transmitter spurious emissions .....	131
9.7.5.1	General .....	131
9.7.5.2	Minimum requirement for <i>IAB-DU type 1-O</i> and <i>IAB-MT type 1-O</i> .....	131
9.7.5.2.1	General .....	131
9.7.5.2.2	General OTA transmitter spurious emissions requirements .....	132
9.7.5.2.3	Additional spurious emissions requirements .....	132
9.7.5.2.4	Co-location with other base stations and IAB-Nodes .....	132
9.7.5.3	Minimum requirement for <i>IAB-DU type 2-O</i> and <i>IAB-MT type 2-O</i> .....	132
9.7.5.3.1	General .....	132
9.7.5.3.2	General OTA transmitter spurious emissions requirements .....	133
9.7.5.3.2.1	General .....	133
9.7.5.3.2.2	OTA transmitter spurious emissions (Category A) .....	133
9.7.5.3.2.3	OTA transmitter spurious emissions (Category B) .....	133
9.7.5.3.3	Additional OTA transmitter spurious emissions requirements .....	134
9.7.5.3.3.1	Limits for protection of Earth Exploration Satellite Service .....	134
9.8	OTA transmitter intermodulation .....	134
9.8.1	General .....	134
9.8.2	Minimum requirement for <i>IAB-DU type 1-O</i> and <i>IAB-MT type 1-O</i> .....	134
10	Radiated receiver characteristics .....	135
10.1	General .....	135
10.2	OTA sensitivity .....	136
10.2.1	IAB-DU OTA sensitivity .....	136
10.2.1.1	IAB-DU type 1-H and IAB-DU type 1-O .....	136
10.2.1.2	IAB-DU type 2-O .....	136
10.2.2	IAB-MT OTA sensitivity .....	136
10.2.2.1	IAB-MT type 1-H and IAB-MT type 1-O .....	136
10.2.2.1.1	General .....	136
10.2.2.1.2	Minimum requirement .....	137
10.2.2.2	IAB-MT type 2-O .....	137
10.3	OTA reference sensitivity level .....	137
10.3.1	General .....	137
10.3.2	IAB-DU OTA reference sensitivity level .....	137
10.3.2.1	Minimum requirement for <i>IAB-DU type 1-O</i> .....	137
10.3.2.2	Minimum requirement for <i>IAB-DU type 2-O</i> .....	138
10.3.3	IAB-MT OTA reference sensitivity level .....	138
10.3.3.1	General .....	138
10.3.3.2	Minimum requirement for <i>IAB-MT type 1-O</i> .....	138
10.3.3.3	Minimum requirement for <i>IAB-MT type 2-O</i> .....	139

10.4	OTA Dynamic range .....	139
10.4.1	IAB-DU OTA dynamic range.....	140
10.4.1.1	General.....	140
10.4.1.2	Minimum requirement for <i>IAB-DU type 1-O</i> .....	140
10.5	OTA in-band selectivity and blocking.....	140
10.5.1	OTA adjacent channel selectivity .....	140
10.5.1.1	General.....	140
10.5.1.2	Minimum requirement for <i>IAB-DU type 1-O</i> .....	140
10.5.1.3	Minimum requirement for <i>IAB-DU type 2-O</i> .....	140
10.5.1.4	Minimum requirement for <i>IAB-MT type 2-O</i> .....	140
10.5.1.5	..... Minimum requirement for <i>IAB-MT type 1-O</i> .....	141
10.5.2	OTA in-band blocking.....	142
10.6	OTA out-of-band blocking.....	146
10.6.1	General.....	146
10.6.2	Minimum requirement for IAB-MT type 1-O and IAB-DU type 1-O.....	146
10.6.3	Minimum requirement for IAB-MT type 2-O and IAB-DU type 2-O.....	146
10.6.4	Co-location minimum requirement for IAB-MT type 1-O and IAB-DU type 1-O.....	147
10.7	OTA receiver spurious emissions.....	147
10.7.1	General.....	147
10.7.2	IAB-DU OTA receiver spurious emissions .....	148
10.7.2.1	Minimum requirement for IAB-DU type 1-O.....	148
10.7.2.2	Minimum requirement for IAB-DU type 2-O.....	148
10.7.3	IAB-MT OTA receiver spurious emissions .....	148
10.7.3.1	Minimum requirement for IAB-MT type 1-O.....	148
10.7.3.2	Minimum requirement for IAB-MT type 2-O.....	148
10.8	OTA receiver intermodulation .....	149
10.8.1	General.....	149
10.8.2	Minimum requirement for <i>IAB-DU type 1-O</i> .....	149
10.8.3	Minimum requirement for <i>IAB-DU type 2-O</i> .....	150
10.8.4	Minimum requirement for <i>IAB-MT type 1-O</i> .....	150
10.9	OTA in-channel selectivity.....	150
10.9.1	General.....	150
10.9.2	Minimum requirement for <i>IAB-DU type 1-O</i> .....	150
10.9.3	Minimum requirement for <i>IAB-DU type 2-O</i> .....	150
11	Radiated performance requirements.....	151
11.1	IAB-DU performance requirements .....	151
11.1.1	General.....	151
11.1.2	OTA demodulation branches .....	151
11.1.2	Performance requirements for PUSCH.....	152
11.1.2.1	Performance requirements for <i>IAB type 1-O</i> .....	152
11.1.2.1.1	Performance requirements for PUSCH with transform precoding disabled.....	152
11.1.2.1.2	Performance requirements for PUSCH with transform precoding enabled.....	152
11.1.2.1.3	Performance requirements for UCI multiplexed on PUSCH.....	152
11.1.2.2	Performance requirements for IAB type 2-O.....	152
11.1.2.2.1	Performance requirements for PUSCH with transform precoding disabled.....	152
11.1.2.2.2	Performance requirements for PUSCH with transform precoding enabled.....	155
11.1.2.2.3	Performance requirements for UCI multiplexed on PUSCH.....	156
11.1.3	Performance requirements for PUCCH .....	158
11.1.3.1	Performance requirements for <i>IAB type 1-O</i> .....	158
11.1.3.1.1	DTX to ACK probability.....	158
11.1.3.1.2	Performance requirements for PUCCH format 0.....	158
11.1.3.1.3	Performance requirements for PUCCH format 1.....	158
11.1.3.1.4	Performance requirements for PUCCH format 2.....	158
11.1.3.1.5	Performance requirements for PUCCH format 3.....	158
11.1.3.1.6	Performance requirements for PUCCH format 4.....	159
11.1.3.1.7	Performance requirements for multi-slot PUCCH.....	159
11.1.3.2	Performance requirements for <i>IAB type 2-O</i> .....	159
11.1.3.2.1	DTX to ACK probability.....	159
11.1.3.2.2	Performance requirements for PUCCH format 0.....	159
11.1.3.2.3	Performance requirements for PUCCH format 1.....	160

11.1.3.2.4	Performance requirements for PUCCH format 2.....	161
11.1.3.2.5	Performance requirements for PUCCH format 3.....	163
11.1.3.2.6	Performance requirements for PUCCH format 4.....	164
11.1.4	Performance requirements for PRACH.....	165
11.1.4.1	Performance requirements for <i>IAB type 1-O</i> .....	165
11.1.4.1.1	PRACH False alarm probability.....	165
11.1.4.1.2	PRACH detection requirements.....	165
11.1.4.2	Performance requirements for <i>IAB type 2-O</i> .....	165
11.1.4.2.1	PRACH false alarm probability.....	165
11.1.4.2.2	PRACH missed detection requirements.....	165
11.2	IAB-MT performance requirements.....	166
11.2.1	General.....	166
11.2.2	OTA demodulation branches.....	167
11.2.2	Demodulation performance requirements.....	167
11.2.2.1	Performance requirements for <i>IAB type 1-O</i> .....	167
11.2.2.1.1	Performance requirements for PDSCH.....	167
11.2.2.1.2	Performance requirements for PDCCH.....	168
11.2.2.2	Performance requirements for <i>IAB type 2-O</i> .....	169
11.2.2.2.1	Performance requirements for PDSCH.....	169
11.2.2.2.2	Performance requirements for PDCCH.....	171
11.2.3	CSI reporting requirements.....	172
11.2.3.1	Performance requirements for <i>IAB type 1-O</i> .....	172
11.2.3.1.1	Reporting of Channel Quality Indicator (CQI).....	172
11.2.3.1.2	Reporting of Precoding Matrix Indicator (PMI).....	172
11.2.3.1.3	Reporting of Rank Indicator (RI).....	172
11.2.3.2	Performance requirements for <i>IAB type 2-O</i> .....	172
11.2.3.2.1	General.....	172
11.2.3.2.2	Reporting of Channel Quality Indicator (CQI).....	174
11.2.3.2.3	Reporting of Precoding Matrix Indicator (PMI).....	175
11.2.3.2.4	Reporting of Rank Indicator (RI).....	177
12	Radio Resource Management requirements.....	179
12.1	RRC_CONNECTED state mobility for IAB-MTs.....	179
12.1.1	RRC Connection Mobility Control.....	179
12.1.1.1	SA: RRC Re-establishment.....	179
12.1.1.1.1	Introduction.....	179
12.1.1.1.2	Requirements.....	179
12.1.1.1.2.1	IAB MT Re-establishment delay requirement.....	179
12.1.1.2	Random access.....	181
12.1.1.3	SA: RRC Connection Release with Redirection.....	181
12.1.1.3.1	Introduction.....	181
12.1.1.3.2	Requirements.....	181
12.1.1.3.2.1	RRC connection release with redirection to NR.....	181
12.2	Timing.....	182
12.2.1	IAB-MT transmit timing.....	182
12.2.1.1	Introduction.....	182
12.2.1.2	Requirements.....	182
12.2.1.2.1	Gradual timing adjustment.....	183
12.2.3	IAB-MT timing advance.....	184
12.2.3.1	Timing Advance adjustment delay.....	184
12.2.3.2	Timing Advance adjustment accuracy.....	184
12.2.4	Cell phase synchronization accuracy.....	184
12.2.4.1	Introduction.....	184
12.2.4.2	Requirements.....	184
12.3	Signalling Characteristics for IAB MTs.....	184
12.3.1	Radio Link Monitoring.....	184
12.3.1.1	Introduction.....	184
12.3.1.2	Requirements for SSB based radio link monitoring.....	184
12.3.1.2.1	Introduction.....	184
12.3.1.2.2	Minimum requirement.....	185
12.3.1.2.3	Measurement restrictions for SSB based RLM.....	186
12.3.1.3	Requirements for CSI-RS based radio link monitoring.....	186

12.3.1.3.1	Introduction .....	186
12.3.1.3.2	Minimum requirement.....	187
12.3.1.3.3	Measurement restrictions for CSI-RS based RLM .....	188
12.3.1.4	Minimum requirement for IAB-MT turning off the transmitter.....	188
12.3.1.5	Minimum requirement for L1 indication.....	188
12.3.1.6	Scheduling availability of IAB-MT during radio link monitoring .....	189
12.3.2	Link Recovery Procedure .....	189
12.3.2.1	Introduction.....	189
12.3.2.2	Requirements for SSB based beam failure detection .....	189
12.3.2.2.1	Introduction .....	189
12.3.2.2.2	Minimum requirement.....	189
12.3.2.2.3	Measurement restriction for SSB based beam failure detection .....	190
12.3.2.3	Requirements for CSI-RS based beam failure detection.....	190
12.3.2.3.1	Introduction .....	190
12.3.2.3.2	Minimum requirement.....	190
12.3.2.3.3	Measurement restrictions for CSI-RS based beam failure detection .....	191
12.3.2.4	Minimum requirement for L1 indication.....	191
12.3.2.5	Requirements for SSB based candidate beam detection .....	191
12.3.2.5.1	Introduction .....	191
12.3.2.5.2	Minimum requirement.....	191
12.3.2.5.3	Measurement restriction for SSB based candidate beam detection .....	192
12.3.2.6	Requirements for CSI-RS based candidate beam detection .....	192
12.3.2.6.1	Introduction .....	192
12.3.2.6.2	Minimum requirement.....	193
12.3.2.6.3	Measurement restriction for CSI-RS based candidate beam detection.....	193
12.3.2.7	Scheduling availability of IAB-MT during beam failure detection.....	194
12.3.2.8	Scheduling availability of IAB-MT during candidate beam detection.....	194
<b>Annex A (normative): IAB-MT Reference measurement channels .....</b>		<b>195</b>
A.1	Fixed Reference Channels for reference sensitivity level, ACS, in-band blocking, out-of-band blocking and receiver intermodulation (QPSK, R=1/3) .....	195
A.2	IAB-DU Fixed Reference Channels .....	195
A.2.1	Fixed Reference Channels for PUSCH performance requirements (QPSK, R=193/1024) .....	195
A.2.2	Fixed Reference Channels for PUSCH performance requirements (16QAM, R=434/1024) .....	200
A.2.3	Fixed Reference Channels for PUSCH performance requirements (16QAM, R=658/1024) .....	201
A.2.4	Fixed Reference Channels for PUSCH performance requirements (64QAM, R=567/1024) .....	204
A.2.5	PRACH Test preambles.....	206
A.3	IAB-MT Fixed Reference Channels.....	206
A.3.1	Fixed Reference Channels for PDSCH performance requirements (16QAM) .....	206
A.3.2	Fixed Reference Channels for PDSCH performance requirements (64QAM) .....	207
A.3.3	Fixed Reference Channels for PDSCH performance requirements (256QAM) .....	208
A.3.4	Fixed Reference Channels for PDCCH performance requirements.....	209
A.3.5	Fixed Reference Channels for CSI reporting performance .....	210
<b>Annex B (normative): IAB-DU Error Vector Magnitude (FR1).....</b>		<b>213</b>
<b>Annex C (normative): IAB-DU Error Vector Magnitude (FR2-1) .....</b>		<b>214</b>
<b>Annex D (normative): IAB-MT Error Vector Magnitude (FR2-1).....</b>		<b>215</b>
D.0	General .....	215
D.1	Reference point for measurement.....	215
D.2	Basic unit of measurement .....	215
D.3	Modified signal under test.....	215
D.4	Estimation of frequency offset .....	215
D.5	Estimation of time offset .....	215
D.6	Estimation of TX chain amplitude and frequency response parameters.....	215
D.7	Averaged EVM .....	215
<b>Annex E (normative): IAB-MT Error Vector Magnitude (FR2) .....</b>		<b>217</b>
E.0	General .....	217
E.1	Reference point for measurement.....	217
E.2	Basic unit of measurement .....	217

E.3	Modified signal under test .....	217
E.4	Estimation of frequency offset .....	217
E.5	Estimation of time offset .....	217
E.6	Estimation of TX chain amplitude and frequency response parameters.....	217
E.7	Averaged EVM .....	217

**Annex F (normative): 219**

F.1	Characteristics of the interfering signals for IAB-DU .....	219
F.2	Characteristics of the interfering signals for IAB-MT.....	219

**Annex G (normative): IAB-MT RRM Testing.....220**

G.1	IAB-MT RRM test configurations .....	221
G.1.1	Reference measurement channels .....	221
G.1.1.1	PDSCH.....	221
G.1.1.1.1	TDD.....	221
G.1.1.2	CORESET for RMSI scheduling .....	224
G.1.1.2.1	TDD.....	224
G.1.1.3	CORESET for RMC scheduling .....	227
G.1.1.3.1	TDD.....	227
G.1.2	OFDMA channel noise generator (OCNG) .....	228
G.1.2.1	Generic OFDMA Channel Noise Generator (OCNG) .....	228
G.1.2.1.1	OCNG pattern 1: Generic OCNG pattern for all unused REs .....	228
G.1.2.1.2	OCNG pattern 2: Generic OCNG pattern for all unused REs for 2AoA setup.....	229
G.1.2.1.3	OCNG pattern 3: Generic OCNG pattern for unused REs in the same bandwidth as PDSCH RMC .....	229
G.1.2.1.4	OCNG pattern 4: Generic OCNG pattern for all unused REs outside SSB slot(s).....	230
G.1.3	Antenna configurations.....	230
G.1.3.1	Antenna configurations for FR1.....	230
G.1.3.1.1	Antenna connection for 4 Rx capable IAB-MT.....	230
G.1.3.2	Antenna configurations for FR2-1 .....	231
G.1.4	BWP configurations.....	231
G.1.4.1	Introduction.....	231
G.1.4.2	Downlink BWP configurations .....	232
G.1.4.2.1	Initial BWP.....	232
G.1.4.2.2	Dedicated BWP .....	232
G.1.4.3	Uplink BWP configurations .....	232
G.1.4.3.1	Initial BWP.....	232
G.1.4.3.2	Dedicated BWP .....	233
G.1.5	SSB Configurations .....	233
G.1.5.1	SSB Configurations for FR1 .....	233
G.1.5.1.1	SSB pattern 1 in FR1: SSB allocation for SSB SCS=15 kHz.....	233
G.1.5.1.2	SSB pattern 2 in FR1: SSB allocation for SSB SCS=30 kHz.....	234
G.1.5.1.3	SSB pattern 3 in FR1: SSB allocation for SSB SCS=15 kHz.....	234
G.1.5.1.4	SSB pattern 4 in FR1: SSB allocation for SSB SCS=30 kHz.....	235
G.1.5.1.5	SSB pattern 5 in FR1: SSB allocation for SSB SCS=15 kHz starting from odd SFN.....	235
G.1.5.1.6	SSB pattern 6 in FR1: SSB allocation for SSB SCS=30 kHz starting from odd SFN.....	236
G.1.5.2	SSB Configurations for FR2-1 .....	236
G.1.5.2.1	SSB pattern 1 in FR2-1: SSB allocation for SSB SCS=120 kHz .....	236
G.1.5.2.2	SSB pattern 2 in FR2-1: SSB allocation for SSB SCS=240 kHz .....	236
G.1.5.2.3	SSB pattern 3 in FR2-1: SSB allocation for SSB SCS=120 kHz .....	237
G.1.5.2.4	SSB pattern 4 in FR2-1: SSB allocation for SSB SCS=240 kHz .....	237
G.1.5.2.5	SSB pattern 5 in FR2-1: SSB allocation for SSB SCS=120 kHz .....	237
G.1.5.2.6	SSB pattern 6 in FR2-1: SSB allocation for SSB SCS=240 kHz .....	238
G.1.5.2.7	SSB pattern 7 in FR2-1: SSB allocation for SSB SCS=120 kHz .....	238
G.1.5.2.8	SSB pattern 8 in FR2-1: SSB allocation for SSB SCS=240 kHz .....	238
G.1.6	SMTC Configurations.....	239
G.1.6.1	SMTC pattern 1: SMTC period = 20 ms with SMTC duration = 1 ms .....	239
G.1.6.2	SMTC pattern 2: SMTC period = 20 ms with SMTC duration = 5 ms .....	239
G.1.6.3	SMTC pattern 3: SMTC period = 160 ms with SMTC duration = 1 ms .....	239
G.1.6.4	SMTC pattern 4: SMTC period = 20 ms with SMTC duration = 1 ms .....	239
G.1.6.5	SMTC pattern 5: SMTC period = 20 ms with SMTC duration = 5 ms .....	239
G.1.7	CSI-RS configurations.....	240

G.1.7.1	TDD .....	240
G.1.8	Angle of Arrival (AoA) for FR2-1 RRM test cases .....	242
G.1.8.1	Setup 1: Single AoA.....	242
G.1.8.2	Setup 2: 2 AoAs .....	242
G.1.9	TCI State Configuration.....	243
G.1.9.1	Introduction.....	243
G.1.9.2	TCI states .....	243
G.1.10	Configurations of CSI-RS for tracking .....	243
G.1.10.1	Configuration of CSI-RS for tracking for FR1.....	243
G.1.10.1.2	TDD.....	243
G.1.10.2	Configuration of CSI-RS for tracking for FR2-1 .....	244
G.1.10.2.1	TDD.....	244
G.2	IAB-MT RRM test cases .....	245
G.2.1	RRC_CONNECTED state mobility for IAB-MTs .....	245
G.2.1.1	RRC Connection Mobility Control .....	245
G.2.1.1.1	RRC Re-establishment .....	245
G.2.1.1.2	RRC Connection Release with Redirection.....	256
G.2.2	Timing .....	261
G.2.2.1	Transmit timing.....	261
G.2.2.1.1	NR IAB-MT Transmit Timing Test for FR1 .....	261
G.2.2.1.2	NR IAB-MT Transmit Timing Test for FR2-1.....	264
G.2.3	Signalling Characteristics for IAB MTs .....	267
G.2.3.1	Radio link Monitoring.....	267
G.2.3.1.1	Radio Link Monitoring Out-of-sync Test for FR1 PCell configured with SSB-based RLM RS in non-DRX mode .....	267
G.2.3.1.2	Radio Link Monitoring In-sync Test for FR1 PCell configured with SSB-based RLM RS in non-DRX mode .....	270
G.2.3.1.3	Radio Link Monitoring Out-of-sync Test for FR2-1 PCell configured with SSB-based RLM RS in non-DRX mode .....	274
G.2.3.1.4	Radio Link Monitoring In-sync Test for FR2-1 PCell configured with SSB-based RLM RS in non-DRX mode .....	277
G.2.3.1.5	Radio Link Monitoring Out-of-sync Test for FR1 PCell configured with CSI-RS-based RLM in non-DRX mode .....	281
G.2.3.1.6	Radio Link Monitoring In-sync Test for FR1 PCell configured with CSI-RS-based RLM in non-DRX mode .....	284
G.2.3.1.7	Radio Link Monitoring Out-of-sync Test for FR2-1 PCell configured with CSI-RS-based RLM in non-DRX mode.....	287
G.2.3.1.8	Radio Link Monitoring In-sync Test for FR2-1 PCell configured with CSI-RS-based RLM in non-DRX mode .....	290
G.2.3.2	Beam Failure Detection and Link Recovery Procedure .....	293
G.2.3.2.1	Beam Failure Detection and Link Recovery Test for FR1 PCell configured with SSB-based BFD and LR .....	293
G.2.3.2.2	Beam Failure Detection and Link Recovery Test for FR2-1 PCell configured with SSB-based BFD and LR .....	297
G.2.3.2.3	Beam Failure Detection and Link Recovery Test for FR1 PCell configured with CSI-RS-based BFD and LR .....	303
G.2.3.2.4	Beam Failure Detection and Link Recovery Test for FR2-1 PCell configured with CSI-RS-based BFD and LR in non-DRX mode.....	307
<b>Annex H (normative): Conditions for IAB-MT RRM requirements applicability for operating bands .....</b>		<b>313</b>
H.1	Conditions for RRC_CONNECTED state mobility for IAB-MT .....	313
H.1.1	Introduction.....	313
H.1.1.1	Conditions for Measurements on NR Intra-frequency Cells for RRC Connection Re-establishment.....	313
H.1.1.2	Conditions for Measurements on NR Inter-frequency Cells for RRC Connection Re-establishment.....	314
H.1.1.3	Conditions for Measurements on NR Cells for RRC Connection Release with Redirection.....	315
<b>Annex I (normative): Propagation conditions .....</b>		<b>317</b>
I.1	.....Static propagation condition.....	317

I.1.1	IAB-MT receiver with 2RX.....	317
I.2	Multi-path fading propagation conditions .....	317
I.2.1	General.....	317
I.2.2	Delay profiles.....	318
I.2.2.1	General .....	318
I.2.2.2	Delay profiles for FR1 .....	319
I.2.3	Combinations of channel model parameters .....	320
I.2.4	MIMO channel correlation matrices .....	320
I.2.4.1	General .....	320
I.2.4.2	MIMO correlation matrices using Uniform Linear Array.....	320
I.2.4.2.1	General .....	320
I.2.4.2.2	Definition of MIMO correlation matrices .....	320
I.2.4.2.3	MIMO correlation matrices at high, medium and low level.....	322
I.2.4.3	Multi-antenna channel models using cross polarized antennas.....	324
I.2.4.3.1	General .....	324
I.2.4.3.2	Definition of MIMO correlation matrices using cross polarized antennas .....	324
I.2.4.3.3	Spatial correlation matrices at IAB-MT/UE and IAB-DU/gNB sides.....	325
I.2.4.3.4	MIMO correlation matrices using cross polarized antennas.....	325
I.2.4.3.5	Beam steering approach.....	326
I.3	Physical signals, channels mapping and precoding.....	327
I.3.1	General.....	327
<b>Annex J (informative): Change history .....</b>		<b>329</b>
History .....		331

---

# Foreword

This Technical Specification has been produced by the 3rd Generation Partnership Project (3GPP).

The contents of the present document are subject to continuing work within the TSG and may change following formal TSG approval. Should the TSG modify the contents of the present document, it will be re-released by the TSG with an identifying change of release date and an increase in version number as follows:

Version x.y.z

where:

- x the first digit:
  - 1 presented to TSG for information;
  - 2 presented to TSG for approval;
  - 3 or greater indicates TSG approved document under change control.
- y the second digit is incremented for all changes of substance, i.e. technical enhancements, corrections, updates, etc.
- z the third digit is incremented when editorial only changes have been incorporated in the document.

In the present document, certain modal verbs have the following meanings:

- shall** indicates a mandatory requirement to do something
- shall not** indicates an interdiction (prohibition) to do something

NOTE 1: The constructions "shall" and "shall not" are confined to the context of normative provisions, and do not appear in Technical Reports.

NOTE 2: The constructions "must" and "must not" are not used as substitutes for "shall" and "shall not". Their use is avoided insofar as possible, and they are not used in a normative context except in a direct citation from an external, referenced, non-3GPP document, or so as to maintain continuity of style when extending or modifying the provisions of such a referenced document.

- should** indicates a recommendation to do something
- should not** indicates a recommendation not to do something
- may** indicates permission to do something
- need not** indicates permission not to do something

NOTE 3: The construction "may not" is ambiguous and is not used in normative elements. The unambiguous constructions "might not" or "shall not" are used instead, depending upon the meaning intended.

- can** indicates that something is possible
- cannot** indicates that something is impossible

NOTE 4: The constructions "can" and "cannot" shall not to be used as substitutes for "may" and "need not".

- will** indicates that something is certain or expected to happen as a result of action taken by an agency the behaviour of which is outside the scope of the present document
- will not** indicates that something is certain or expected not to happen as a result of action taken by an agency the behaviour of which is outside the scope of the present document
- might** indicates a likelihood that something will happen as a result of action taken by some agency the behaviour of which is outside the scope of the present document



**might not** indicates a likelihood that something will not happen as a result of action taken by some agency the behaviour of which is outside the scope of the present document

In addition:

**is** (or any other verb in the indicative mood) indicates a statement of fact

**is not** (or any other negative verb in the indicative mood) indicates a statement of fact

NOTE 5: The constructions "is" and "is not" do not indicate requirements.

---

# 1 Scope

The present document establishes the minimum RF characteristics, minimum radio resource management (RRM) requirements, RRM test cases and minimum performance requirements of NR Integrated access and backhaul (IAB).

---

# 2 References

The following documents contain provisions which, through reference in this text, constitute provisions of the present document.

- References are either specific (identified by date of publication, edition number, version number, etc.) or non-specific.
- For a specific reference, subsequent revisions do not apply.
- For a non-specific reference, the latest version applies. In the case of a reference to a 3GPP document (including a GSM document), a non-specific reference implicitly refers to the latest version of that document *in the same Release as the present document*.

- [1] 3GPP TR 21.905: "Vocabulary for 3GPP Specifications".
- [2] 3GPP TS 38.104: "NR; Base Station (BS) radio transmission and reception"
- [3] 3GPP TS 38.101-1: "NR User Equipment (UE) radio transmission and reception; Part 1: Range 1 Standalone"
- [4] 3GPP TS 38.101-2: "NR User Equipment (UE) radio transmission and reception: Part 2: Range 2 Standalone"
- [5] 3GPP TS 38.101-3: "NR; User Equipment (UE) radio transmission and reception; Part 3: Range 1 and Range 2 Interworking operation with other radios "
- [6] 3GPP TS 38.133: "NR: Requirements for support of radio resource management"
- [7] 3GPP TS 38.300: "NR; Overall description; Stage-2".
- [8] 3GPP TS 38.211: "NR; Physical channels and modulation".
- [9] 3GPP TS 38.212 "NR; Multiplexing and channel coding".
- [10] 3GPP TS 38.213: "NR; Physical layer procedures for control".
- [11] 3GPP TS 38.214: "NR; Physical layer procedures for data".
- [12] 3GPP TS 38.215: "NR; Physical layer measurements".
- [13] 3GPP TS 38.304: "NR; User Equipment (UE) procedures in idle mode".
- [14] 3GPP TS 38.321: "NR; Medium Access Control (MAC) protocol specification".
- [15] 3GPP TS 38.331: "NR; Radio Resource Control (RRC); Protocol specification".
- [16] ITU-R Recommendation SM.329: "Unwanted emissions in the spurious domain".
- [17] ERC Recommendation 74-01, "Unwanted emissions in the spurious domain".
- [18] ITU-R Recommendation M.1545: "Measurement uncertainty as it applies to test limits for the terrestrial component of International Mobile Telecommunications – 2000"
- [19] Recommendation ITU-R SM.328: "Spectra and bandwidth of emissions".
- [20] "Title 47 of the Code of Federal Regulations (CFR)", Federal Communications Commission.

- [21] 3GPP TS 38.141-2: "NR; Base Station (BS) conformance testing; Part 2: Radiated conformance testing".
- [22] 3GPP TS 38.141-1: "NR; Base Station (BS) conformance testing; Part 1: Conducted conformance testing".
- [23] 3GPP TS 38.521-1: "NR; User Equipment (UE) conformance specification; Radio transmission and reception; Part 1: Range 1 Standalone".
- [24] 3GPP TS 38.521-2: "NR; User Equipment (UE) conformance specification; Radio transmission and reception; Part 2: Range 2 Standalone".
- [25] 3GPP TS 38.176-1: "NR; Integrated Access and Backhaul (IAB) conformance testing; Part 1: Conducted conformance testing".
- [26] 3GPP TS 38.176-2: "NR; Integrated Access and Backhaul (IAB) conformance testing; Part 2: Radiated conformance testing".
- [27] 3GPP TR 38.901: "Study on channel model for frequencies from 0.5 to 100 GHz"
- [28] 3GPP TR 38.101-4: "NR; User Equipment (UE) radio transmission and reception; Part 4: Performance requirements"

---

## 3 Definitions, symbols and abbreviations

### 3.1 Definitions

For the purposes of the present document, the terms given in 3GPP TR 21.905 [1] and the following apply. A term defined in the present document takes precedence over the definition of the same term, if any, in 3GPP TR 21.905 [1].

**active transmitter unit:** transmitter unit which is ON, and has the ability to send modulated data streams that are parallel and distinct to those sent from other transmitter units to one or more *IAB type 1-H TAB connectors* at the *transceiver array boundary* or to the *radiated interface boundary* for *IAB-MT type 1-O*.

**Aggregated IAB-DU Channel Bandwidth:** The RF bandwidth in which an IAB-DU transmits and receives multiple contiguously aggregated carriers. The aggregated IAB-DU channel bandwidth is measured in MHz.

**Aggregated IAB-MT Channel Bandwidth:** The RF bandwidth in which an IAB-MT transmits and receives multiple contiguously aggregated carriers. The aggregated IAB-MT channel bandwidth is measured in MHz.

**basic limit:** emissions limit relating to the power supplied by a single transmitter to a single antenna transmission line in ITU-R SM.329 [16] used for the formulation of unwanted emission requirements for FR1

**beam:** beam (of the antenna) is the main lobe of the radiation pattern of an *antenna array*

NOTE: For certain *antenna array*, there may be more than one beam.

**beam centre direction:** direction equal to the geometric centre of the half-power contour of the beam

**beam direction pair:** data set consisting of the *beam centre direction* and the related *beam peak direction*

**beam peak direction:** direction where the maximum EIRP is found

**beamwidth:** beam which has a half-power contour that is essentially elliptical, the half-power beamwidths in the two pattern cuts that respectively contain the major and minor axis of the ellipse

**BS channel bandwidth:** RF bandwidth supporting a single NR RF carrier with the *transmission bandwidth* configured in the uplink or downlink

NOTE 1: The *BS channel bandwidth* is measured in MHz and is used as a reference for transmitter and receiver RF requirements.

NOTE 2: It is possible for the BS to transmit to and/or receive from one or more UE bandwidth parts that are smaller than or equal to the *BS transmission bandwidth configuration*, in any part of the *BS transmission bandwidth configuration*.

**BS type 1-H:** NR base station operating at FR1 with a *requirement set* consisting of conducted requirements defined at individual *TAB connectors* and OTA requirements defined at RIB

**BS type 1-O:** NR base station operating at FR1 with a *requirement set* consisting only of OTA requirements defined at the RIB

**BS type 2-O:** NR base station operating at FR2 with a *requirement set* consisting only of OTA requirements defined at the RIB

**Channel edge:** lowest or highest frequency of the NR carrier, separated by the *IAB-MT channel bandwidth* or *IAB-DU channel bandwidth*.

**Carrier aggregation:** aggregation of two or more component carriers in order to support wider *transmission bandwidths*

**Carrier aggregation configuration:** a set of one or more *operating bands* across which the IAB-DU or IAB-MT aggregates carriers with a specific set of technical requirements

**co-location reference antenna:** a passive antenna used as reference for co-location requirements

**Contiguous spectrum:** spectrum consisting of a contiguous block of spectrum with no *sub-block gap(s)*.

**directional requirement:** requirement which is applied in a specific direction within the *OTA coverage range* for the Tx and when the AoA of the incident wave of a received signal is within the *OTA REFSENS RoAoA* or the *minSENS RoAoA* as appropriate for the receiver

**equivalent isotropic radiated power:** equivalent power radiated from an isotropic directivity device producing the same field intensity at a point of observation as the field intensity radiated in the direction of the same point of observation by the discussed device

NOTE: Isotropic directivity is equal in all directions (i.e. 0 dBi).

**equivalent isotropic sensitivity:** sensitivity for an isotropic directivity device equivalent to the sensitivity of the discussed device exposed to an incoming wave from a defined AoA

NOTE 1: The sensitivity is the minimum received power level at which specific requirement is met.

NOTE 2: Isotropic directivity is equal in all directions (i.e. 0 dBi).

**fractional bandwidth:** *fractional bandwidth* FBW is defined as  $FBW = 200 \cdot \frac{F_{FBW_{high}} - F_{FBW_{low}}}{F_{FBW_{high}} + F_{FBW_{low}}} \%$

**highest carrier:** The carrier with the highest carrier frequency transmitted/received in a specified frequency band.

**IAB-DU channel bandwidth:** RF bandwidth supporting a single IAB-DU RF carrier with the *transmission bandwidth* configured in the uplink or downlink

NOTE 1: The *IAB-DU channel bandwidth* is measured in MHz and is used as a reference for transmitter and receiver RF requirements.

NOTE 2: It is possible for the IAB to transmit to and/or receive from one or more UE bandwidth parts that are smaller than or equal to the *IAB transmission bandwidth configuration*, in any part of the *IAB transmission bandwidth configuration*.

**IAB-MT channel bandwidth:** RF bandwidth supporting a single IAB-MT RF carrier with the *transmission bandwidth* configured in the uplink or downlink

NOTE 1: The *IAB-MT channel bandwidth* is measured in MHz and is used as a reference for transmitter and receiver RF requirements.

**IAB-donor:** gNB that provides network access to UEs via a network of backhaul and access links.

**IAB-DU RF Bandwidth:** RF bandwidth in which an IAB-DU transmits and/or receives single or multiple carrier(s) within a supported *operating band*

**IAB-DU RF Bandwidth edge:** frequency of one of the edges of the *IAB-DU RF Bandwidth*.

**IAB-MT RF Bandwidth:** RF bandwidth in which an IAB-MT transmits and/or receives single or multiple carrier(s) within a supported *operating band*

NOTE: In single carrier operation, the *IAB-MT RF Bandwidth* is equal to the *IAB-MT channel bandwidth*.

**IAB RF Bandwidth:** RF bandwidth in which an IAB-DU and/or IAB-MT transmits and/or receives single or multiple carrier(s) within a supported *operating band*

**IAB RF Bandwidth edge:** frequency of one of the edges of the *IAB RF Bandwidth*.

**IAB Simultaneous Operation:** IAB-DU and IAB-MT operating with simultaneous transmission, or simultaneous reception.

**IAB-MT RF Bandwidth edge:** frequency of one of the edges of the *IAB-MT RF Bandwidth*.

**IAB type 1-H:** IAB-DU or IAB-MT operating at FR1 with a *requirement set* consisting of conducted requirements defined at individual *TAB connectors* and OTA requirements defined at RIB

**IAB type 1-O:** IAB-DU or IAB-MT operating at FR1 with a *requirement set* consisting only of OTA requirements defined at the RIB

**IAB type 2-O:** IAB-DU or IAB-MT operating at FR2 with a *requirement set* consisting only of OTA requirements defined at the RIB

**inter-band gap:** The frequency gap between two supported consecutive *operating bands*.

**Inter RF Bandwidth gap:** frequency gap between two consecutive *IAB-DU* and/or *IAB-MT RF Bandwidths* that are placed within two supported *operating bands*

**lowest Carrier:** The carrier with the lowest carrier frequency transmitted/received in a specified frequency band.

**maximum carrier output power:** mean power level measured per carrier at the indicated interface, during the *transmitter ON period* in a specified reference condition

**maximum carrier TRP output power:** mean power level measured per RIB during the *transmitter ON period* for a specific carrier in a specified reference condition and corresponding to the declared *rated carrier TRP output power* ( $P_{\text{rated,c,TRP}}$ )

**measurement bandwidth:** RF bandwidth in which an emission level is specified

**minSENS:** the lowest declared EIS value for the OSDD's declared for OTA sensitivity requirement.

**minSENS RoAoA:** The *reference RoAoA* associated with the OSDD with the lowest declared EIS

**multi-band connector:** *TAB connector* of *IAB type 1-H* associated with a transmitter or receiver that is characterized by the ability to process two or more carriers in common active RF components simultaneously, where at least one carrier is configured at a different *operating band* than the other carrier(s) and where this different *operating band* is not a *sub-band* or *superseding-band* of another supported *operating band*

**multi-band RIB:** *operating band* specific RIB associated with a transmitter or receiver that is characterized by the ability to process two or more carriers in common active RF components simultaneously, where at least one carrier is configured at a different *operating band* than the other carrier(s) and where this different *operating band* is not a *sub-band* or *superseding-band* of another supported *operating band*

**Non-contiguous spectrum:** spectrum consisting of two or more *sub-blocks* separated by *sub-block gap(s)*.

**operating band:** frequency range in which NR operates (paired or unpaired), that is defined with a specific set of technical requirements

NOTE: The *operating band(s)* for an IAB-DU and IAB-MT are declared by the manufacturer

**OTA coverage range:** a common range of directions within which TX OTA requirements that are neither specified in the *OTA peak directions sets* nor as *TRP requirement* are intended to be met

**OTA peak directions set:** set(s) of *beam peak directions* within which certain TX OTA requirements are intended to be met, where all *OTA peak directions set(s)* are subsets of the *OTA coverage range*

NOTE: The *beam peak directions* are related to a corresponding contiguous range or discrete list of *beam centre directions* by the *beam direction pairs* included in the set.

**OTA REFSENS RoAoA:** the RoAoA determined by the contour defined by the points at which the achieved EIS is 3dB higher than the achieved EIS in the reference direction assuming that for any AoA, the receiver gain is optimized for that AoA

NOTE: This contour will be related to the average element/sub-array radiation pattern 3dB beamwidth.

**OTA sensitivity directions declaration:** set of manufacturer declarations comprising at least one set of declared minimum EIS values (with *IAB-DU* or *IAB-MT channel bandwidth*), and related directions over which the EIS applies

NOTE: All the directions apply to all the EIS values in an OSDD.

**Parent node:** IAB-MT's next hop neighbour node; the parent node can be IAB-node or IAB-donor.

**polarization match:** condition that exists when a plane wave, incident upon an antenna from a given direction, has a polarization that is the same as the receiving polarization of the antenna in that direction

**radiated interface boundary:** *operating band* specific radiated requirements reference where the radiated requirements apply

NOTE: For requirements based on EIRP/EIS, the *radiated interface boundary* is associated to the far-field region

**Radio Bandwidth:** frequency difference between the upper edge of the highest used carrier and the lower edge of the lowest used carrier

**rated beam EIRP:** For a declared beam and *beam direction pair*, the *rated beam EIRP* level is the maximum power that the IAB-DU or IAB-MT is declared to radiate at the associated *beam peak direction* during the *transmitter ON period*

**rated carrier output power:** mean power level associated with a particular carrier the manufacturer has declared to be available at the indicated interface, during the *transmitter ON period* in a specified reference condition

**rated carrier TRP output power:** mean power level declared by the manufacturer per carrier, for IAB-DU or IAB-MT operating in single carrier, multi-carrier, or carrier aggregation configurations that the manufacturer has declared to be available at the RIB during the *transmitter ON period*

**rated total output power:** mean power level associated with a particular *operating band* the manufacturer has declared to be available at the indicated interface, during the *transmitter ON period* in a specified reference condition

**rated total TRP output power:** mean power level declared by the manufacturer, that the manufacturer has declared to be available at the RIB during the *transmitter ON period*

**reference beam direction pair:** declared *beam direction pair*, including reference *beam centre direction* and reference *beam peak direction* where the reference *beam peak direction* is the direction for the intended maximum EIRP within the *OTA peak directions set*

**receiver target:** AoA in which reception is performed by *IAB type 1-H* or *IAB type 1-O*

**receiver target redirection range:** union of all the *sensitivity RoAoA* achievable through redirecting the *receiver target* related to particular OSDD

**receiver target reference direction:** direction inside the *OTA sensitivity directions declaration* declared by the manufacturer for conformance testing. For an OSDD without *receiver target redirection range*, this is a direction inside the *sensitivity RoAoA*

**reference RoAoA:** the *sensitivity RoAoA* associated with the *receiver target reference direction* for each OSDD.

**requirement set:** one of the NR requirement sets as defined for *IAB type 1-H*, *IAB type 1-O*, and *IAB type 2-O*

**sensitivity RoAoA:** RoAoA within the *OTA sensitivity directions declaration*, within which the declared EIS(s) of an OSD is intended to be achieved at any instance of time for a specific IAB-DU or IAB-MT direction setting

**single-band connector:** *IAB type 1-H TAB connector* supporting operation either in a single *operating band* only, or in multiple *operating bands* but does not meet the conditions for a *multi-band connector*.

**sub-band:** A *sub-band* of an operating band contains a part of the uplink and downlink frequency range of the operating band.

**sub-block:** one contiguous allocated block of spectrum for transmission and reception by the same IAB-DU and/or IAB-MT

NOTE: There may be multiple instances of *sub-blocks* within a *IAB RF Bandwidth*.

**sub-block gap:** frequency gap between two consecutive sub-blocks within a *IAB RF Bandwidth*, where the RF requirements in the gap are based on co-existence for un-coordinated operation

**superseding-band:** A *superseding-band* of an operating band includes the whole of the uplink and downlink frequency range of the operating band.

**TAB connector:** *transceiver array boundary connector*

**TAB connector RX min cell group:** *operating band* specific declared group of *TAB connectors* to which *IAB type 1-H* conducted RX requirements are applied

NOTE: Within this definition, the group corresponds to the group of *TAB connectors* which are responsible for receiving a cell when the *IAB type 1-H* setting corresponding to the declared minimum number of cells with reception on all *TAB connectors* supporting an *operating band*, but its existence is not limited to that condition

**TAB connector TX min cell group:** *operating band* specific declared group of *TAB connectors* to which *IAB type 1-H* conducted TX requirements are applied.

NOTE: Within this definition, the group corresponds to the group of *TAB connectors* which are responsible for transmitting a cell when the *IAB type 1-H* setting corresponding to the declared minimum number of cells with transmission on all *TAB connectors* supporting an *operating band*, but its existence is not limited to that condition

**total radiated power:** is the total power radiated by the antenna

NOTE: The *total radiated power* is the power radiating in all direction for two orthogonal polarizations. *Total radiated power* is defined in both the near-field region and the far-field region

**transceiver array boundary:** conducted interface between the transceiver unit array and the composite antenna

**transmission bandwidth:** RF Bandwidth of an instantaneous transmission from an IAB-DU or IAB-MT, measured in resource block units

**transmitter OFF period:** time period during which the IAB-DU or IAB-MT transmitter is not allowed to transmit

**transmitter ON period:** time period during which the IAB-DU or IAB-MT transmitter is transmitting data and/or reference symbols

**transmitter transient period:** time period during which the transmitter is changing from the OFF period to the ON period or vice versa

## 3.2 Symbols

For the purposes of the present document, the following symbols apply:

$\beta$	Percentage of the mean transmitted power emitted outside the occupied bandwidth on the assigned channel
---------	---

$BeW_{\theta,REFSENS}$	Beamwidth equivalent to the <i>OTA REFSENS RoAoA</i> in the $\theta$ -axis in degrees. Applicable for FR1 only.
$BeW_{\phi,REFSENS}$	Beamwidth equivalent to the <i>OTA REFSENS RoAoA</i> in the $\phi$ -axis in degrees. Applicable for FR1 only.
$BW_{Channel}$	<i>IAB channel bandwidth</i>
$BW_{Channel\_CA}$	<i>Aggregated IAB Channel Bandwidth</i> , expressed in MHz. $BW_{Channel\_CA} = F_{edge,high} - F_{edge,low}$ .
$BW_{Config}$	<i>Transmission bandwidth configuration</i> , where $BW_{Config} = N_{RB} \times SCS \times 12$
$BW_{Contiguous}$	<i>Contiguous transmission bandwidth</i> , i.e. <i>IAB channel bandwidth</i> for single carrier or <i>Aggregated IAB channel bandwidth</i> for contiguously aggregated carriers. For non-contiguous operation within a band the term is applied per <i>sub-block</i> .
$\Delta f$	Separation between the <i>channel edge</i> frequency and the nominal -3 dB point of the measuring filter closest to the carrier frequency
$\Delta f_{max}$	$f_{offset,max}$ minus half of the bandwidth of the measuring filter
$\Delta f_{OBUE}$	Maximum offset of the <i>operating band</i> unwanted emissions mask from the downlink <i>operating band edge</i>
$\Delta f_{OOB}$	Maximum offset of the out-of-band boundary from the uplink <i>operating band edge</i>
$\Delta_{FR2\_REFSENS}$	Offset applied to the FR2 OTA REFSENS depending on the AoA
$\Delta_{minSENS}$	Difference between conducted reference sensitivity and minSENS
$\Delta_{OTAREFSSENS}$	Difference between conducted reference sensitivity and OTA REFSENS
$EIS_{minSENS}$	The EIS declared for the <i>minSENS RoAoA</i>
$EIS_{REFSENS}$	OTA REFSENS EIS value
$EIS_{REFSENS\_50M}$	Declared OTA reference sensitivity basis level for FR2 based on a reference measurement channel with 50MHz <i>IAB channel bandwidth</i>
$\hat{E}_s$	Received energy per RE (power normalized to the subcarrier spacing) during the useful part of the symbol, i.e. excluding the cyclic prefix, at the IAB-MT TAB connector or RIB
$F_{FBWhigh}$	Highest supported frequency within supported <i>operating band</i> , for which <i>fractional bandwidth</i> support was declared
$F_{FBWlow}$	Lowest supported frequency within supported <i>operating band</i> , for which <i>fractional bandwidth</i> support was declared
$F_{C,low}$	The $F_c$ of the <i>lowest carrier</i> , expressed in MHz.
$F_{C,high}$	The $F_c$ of the <i>highest carrier</i> , expressed in MHz.
$F_{DL,low}$	The lowest frequency of the downlink <i>operating band</i>
$F_{DL,high}$	The highest frequency of the downlink <i>operating band</i>
$F_{edge,low}$	The lower edge of <i>Aggregated IAB Channel Bandwidth</i> , expressed in MHz. $F_{edge,low} = F_{C,low} - F_{offset,low}$ .
$F_{edge,high}$	The upper edge of <i>Aggregated IAB Channel Bandwidth</i> , expressed in MHz. $F_{edge,high} = F_{C,high} + F_{offset,high}$ .
$f_{offset}$	Separation between the <i>channel edge</i> frequency and the centre of the measuring filter
$f_{offset,max}$	The offset to the frequency $\Delta f_{OBUE}$ outside the downlink <i>operating band</i>
$F_{step,X}$	Frequency steps for the OTA transmitter spurious emissions (Category B)
$F_{UL,low}$	The lowest frequency of the uplink <i>operating band</i>
$F_{UL,high}$	The highest frequency of the uplink <i>operating band</i>
$I_{Io}$	The total received power density, including signal and interference, as measured at the IAB-MT TAB connector or RIB.
$I_{oc}$	The power spectral density (integrated in a noise bandwidth equal to the chip rate and normalized to the chip rate) of a band limited noise source (simulating interference from cells, which are not defined in a test procedure) as measured at the IAB-MT TAB connector or RIB.
$I_{ot}$	The received power spectral density of the total noise and interference for a certain IAB-MT (power integrated over the RE and normalized to the subcarrier spacing) as measured at the IAB-MT TAB connector or RIB
$N_{oc}$	The power spectral density of a white noise source (average power per RE normalised to the subcarrier spacing), simulating interference from cells that are not defined in a test procedure, as measured at the IAB-MT TAB connector or RIB
$N_{cells}$	The declared number corresponding to the minimum number of cells that can be transmitted by an <i>IAB type 1-H</i> in a particular <i>operating band</i>
$N_{RXU,active}$	The number of active receiver units. The same as the number of <i>demodulation branches</i> to which compliance is declared for chapter 8 performance requirements
$N_{RXU,counted}$	The number of active receiver units that are taken into account for conducted Rx spurious emission scaling, as calculated in clause 7.6.1
$N_{RXU,countedpercell}$	The number of active receiver units that are taken into account for conducted RX spurious emissions scaling per cell, as calculated in clause 7.6.1



$N_{RXU,OTAactive}$	The number of active receiver units for an IAB-MT type 1-O declared by the manufacturer
$N_{RXU,OTApercell}$	The number of active receiver units that are taken into account for radiated RX emissions scaling per cell, as calculated in clause 10.7.1
$N_{TA}$	Timing offset between uplink and downlink radio frames at the UE / IAB-MT, as defined in clause 4.2.3 in TS 38.213
$N_{TXU,counted}$	The number of <i>active transmitter units</i> as calculated in clause 6.1, that are taken into account for conducted TX output power limit in clause 6.2.1, and for unwanted TX emissions scaling
$N_{TXU,countedpercell}$	The number of <i>active transmitter units</i> that are taken into account for conducted TX emissions scaling per cell, as calculated in clause 6.1
$N_{TXU,OTAactive}$	The number of <i>active transmitter units</i> for an IAB-MT type 1-O declared by the manufacturer
$N_{TXU,OTApercell}$	The number of <i>active transmitter units</i> that are taken into account for radiated TX emissions scaling per cell, as calculated in clause 9.1
$P_{CMAX, f, c}$	The configured maximum output power for carrier $f$ of serving cell $c$ in each slot
$P_{max,c,TABC}$	The <i>maximum carrier output power per TAB connector</i>
$P_{max,c,TRP}$	<i>Maximum carrier TRP output power</i> measured at the RIB(s), and corresponding to the declared <i>rated carrier TRP output power</i> ( $P_{rated,c,TRP}$ )
$P_{max,c,EIRP}$	The maximum carrier EIRP when the NR IAB is configured at the maximum rated carrier output TRP ( $P_{rated,c,TRP}$ )
$P_{rated,c,cell}$	The <i>rated carrier output power per TAB connector TX min cell group</i>
$P_{rated,c,EIRP}$	The <i>rated carrier EIRP output power</i> declared per RIB
$P_{rated,c,FBHigh}$	The rated carrier EIRP for the higher supported frequency range within supported <i>operating band</i> , for which <i>fractional bandwidth</i> support was declared
$P_{rated,c,FBLow}$	The rated carrier EIRP for the lower supported frequency range within supported <i>operating band</i> , for which <i>fractional bandwidth</i> support was declared
$P_{rated,c,sys}$	The sum of $P_{rated,c,TABC}$ for all <i>TAB connectors</i> for a single carrier
$P_{rated,c,TABC}$	The <i>rated carrier output power per TAB connector</i>
$P_{rated,c,TRP}$	<i>Rated carrier TRP output power</i> declared per RIB
$P_{rated,t,TABC}$	The <i>rated total output power</i> declared at <i>TAB connector</i>
$P_{rated,t,TRP}$	<i>Rated total TRP output power</i> declared per RIB
$P_{REFSENS}$	Conducted Reference Sensitivity power level
SSB_RP	Received (linear) average power of the resource elements that carry SSB signals and channels, measured at the IAB-MT TAB connector or RIB
$T_c$	Basic time unit, defined in clause 4.1 of TS 38.211 [8]
$W_{gap}$	<i>Sub-block gap</i> or <i>Inter RF Bandwidth gap</i> size

### 3.3 Abbreviations

For the purposes of the present document, the abbreviations given in 3GPP TR 21.905 [1] and the following apply. An abbreviation defined in the present document takes precedence over the definition of the same abbreviation, if any, in 3GPP TR 21.905 [1].

AA	Antenna Array
ACLR	Adjacent Channel Leakage Ratio
ACS	Adjacent Channel Selectivity
AoA	Angle of Arrival
AWGN	Additive White Gaussian Noise
BFD	Beam Failure Detection
BFD-RS	BFD Reference Signal
BLER	Block Error Rate
BM-RS	Beam Management Reference Signal
BS	Base Station
BW	Bandwidth
BWP	Bandwidth Part
CA	Carrier Aggregation
CACLR	Cumulative ACLR
CBD	Candidate Beam Detection
CCE	Control Channel Element
CORESET	Control Resource Set
CP	Cyclic Prefix

CP-OFDM	Cyclic Prefix-OFDM
CSI	Channel-State Information
CSI-RS	CSI Reference Signal
CW	Continuous Wave
DCI	Downlink Control Information
DL	Downlink
DMRS	Demodulation Reference Signal
DM-RS	Demodulation Reference Signal
DRX	Discontinuous Reception
EIS	Equivalent Isotropic Sensitivity
EIRP	Equivalent Isotropic Radiated Power
E-UTRA	Evolved UTRA
EVM	Error Vector Magnitude
FBW	Fractional Bandwidth
FR	Frequency Range
FRC	Fixed Reference Channel
GSM	Global System for Mobile communications
IAB	Integrated Access and Backhaul
IAB-DU	IAB Distribution Unit
IAB-MT	IAB Mobile Termination
ITU-R	Radiocommunication Sector of the International Telecommunication Union
ICS	In-Channel Selectivity
L1-RSRP	Layer 1 RSRP
LA	Local Area
MCS	Modulation and Coding Scheme
MGRP	Measurement Gap Repetition Period
MR	Medium Range
NB-IoT	Narrowband – Internet of Things
NR	New Radio
NR-ARFCN	NR Absolute Radio Frequency Channel Number
OBUE	Operating Band Unwanted Emissions
OOB	Out-of-band
OSDD	OTA Sensitivity Directions Declaration
OTA	Over-The-Air
PCell	Primary Cell
PDCCH	Physical Downlink Control Channel
PDSCH	Physical Downlink Shared Channel
PCell	Primary Cell
PRACH	Physical RACH
PDCCH	Physical Downlink Control Channel
PDSCH	Physical Downlink Shared Channel
PRACH	Physical RACH
PRB	Physical Resource Block
PSCell	Primary SCell
PSS	Primary Synchronization Signal
pTAG	Primary Timing Advance Group
PUCCH	Physical Uplink Control Channel
PUSCH	Physical Uplink Shared Channel
QAM	Quadrature Amplitude Modulation
QCL	Quasi Co-Location
RB	Resource Block
RDN	Radio Distribution Network
RE	Resource Element
REFSENS	Reference Sensitivity
REG	Resource Element Group
RF	Radio Frequency
RIB	Radiated Interface Boundary
RLM	Radio Link Monitoring
RLM-RS	Reference Signal for RLM
RMS	Root Mean Square (value)
RoAoA	Range of Angles of Arrival

RRC	Radio Resource Control
RRM	Radio Resource Management
RX	Receiver
SCell	Secondary Cell
SCS	Sub-Carrier Spacing
SMTC	SSB-based Measurement Timing configuration
SpCell	Special Cell
SRS	Sounding Reference Signal
SS-RSRP	Synchronization Signal based Reference Signal Received Power
SSB	Synchronization Signal Block
SSB_RP	Received (linear) average power of the resource elements that carry NR SSB signals and channels, measured at the IAB-MT TAB connector or RIB.
SSS	Secondary Synchronization Signal
TA	Timing Advance
TAB	Transceiver Array Boundary
TCI	Transmission Configuration Indicator
TX	Transmitter
TRP	Total Radiated Power
UTRA	Universal Terrestrial Radio Access
WA	Wide Area

---

## 4 General

### 4.1 Relationship with other core specifications

The present document is a single-RAT specification for an IAB-DU and IAB-MT, covering RF characteristics and minimum performance requirements and RRM requirements for the IAB-MT. Conducted and radiated core requirements are defined for the IAB node architectures and IAB node types defined in subclause 4.3.

The applicability of each requirement is described in clause 4.6.

### 4.2 Relationship between minimum requirements and test requirements

Conformance to the present specification is demonstrated by fulfilling the test requirements specified in the conformance specification TS 38.176-1 [25] and TS 38.176-2 [26].

The minimum requirements given in this specification make no allowance for measurement uncertainty. The test specifications TS 38.176-1 [25] and TS 38.176-2 [26] define test tolerances. These test tolerances are individually calculated for each test. The test tolerances are used to relax the minimum requirements in this specification to create test requirements. For some requirements, including regulatory requirements, the test tolerance is set to zero.

The measurement results returned by the test system are compared - without any modification - against the test requirements as defined by the shared risk principle.

The shared risk principle is defined in recommendation ITU-R M.1545 [18].

### 4.3 Conducted and radiated requirement reference points

### 4.3.2 IAB type 1-H

For *IAB type 1-H*, the requirements are defined for two points of reference, signified by radiated requirements and conducted requirements.

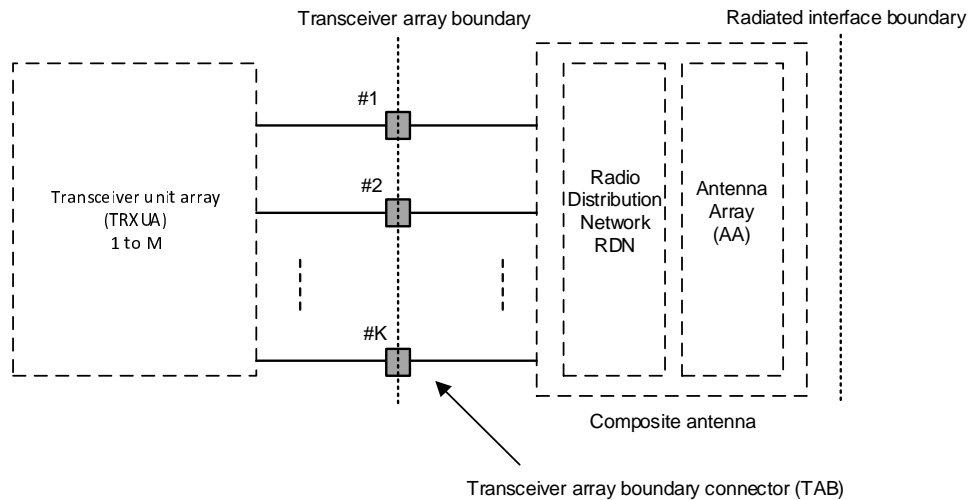

**Figure 4.3.2-1: Radiated and conducted reference points for *IAB type 1-H***

Radiated characteristics are defined over the air (OTA), where the *operating band* specific radiated interface is referred to as the *Radiated Interface Boundary* (RIB). Radiated requirements are also referred to as OTA requirements. The (spatial) characteristics in which the OTA requirements apply are detailed for each requirement.

Conducted characteristics are defined at individual or groups of *TAB connectors* at the *transceiver array boundary*, which is the conducted interface between the transceiver unit array and the composite antenna.

The transceiver unit array is part of the composite transceiver functionality generating modulated transmit signal structures and performing receiver combining and demodulation.

The transceiver unit array contains an implementation specific number of transmitter units and an implementation specific number of receiver units. Transmitter units and receiver units may be combined into transceiver units. The transmitter/receiver units have the ability to transmit/receive parallel independent modulated symbol streams.

The composite antenna contains a radio distribution network (RDN) and an antenna array. The RDN is a linear passive network which distributes the RF power generated by the transceiver unit array to the antenna array, and/or distributes the radio signals collected by the antenna array to the transceiver unit array, in an implementation specific way.

How a conducted requirement is applied to the *transceiver array boundary* is detailed in the respective requirement subclause.

### 4.3.3 IAB type 1-O and IAB type 2-O

For *IAB type 1-O* and *IAB type 2-O*, the radiated characteristics are defined over the air (OTA), where the *operating band* specific radiated interface is referred to as the *Radiated Interface Boundary* (RIB). Radiated requirements are also referred to as OTA requirements. The (spatial) characteristics in which the OTA requirements apply are detailed for each requirement.

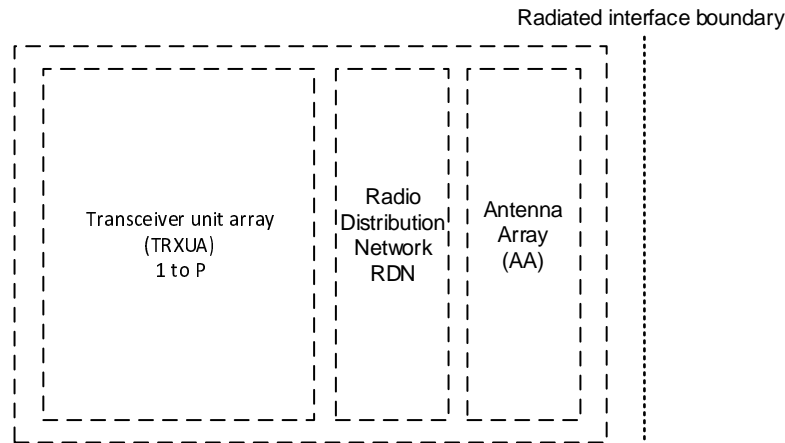

**Figure 4.3.3-1: Radiated reference points for IAB type 1-O and IAB type 2-O**

For an IAB-DU type 1-O the transceiver unit array must contain at least 8 transmitter units and at least 8 receiver units. Transmitter units and receiver units may be combined into transceiver units. The transmitter/receiver units have the ability to transmit/receive parallel independent modulated symbol streams.

## 4.4 IAB classes

### 4.4.1 IAB-DU classes

The requirements in this specification apply to Wide Area IAB-DU, Medium Range IAB-DU and Local Area IAB-DU unless otherwise stated. The associated deployment scenarios for each class are exactly the same for IAB-DU with and without connectors.

For IAB type 1-O and 2-O, IAB-DU classes are defined as indicated below:

- Wide Area IAB-DU are characterised by requirements derived from Macro Cell scenarios with an IAB-DU to UE minimum distance along the ground equal to 35 m.
- Medium Range IAB-DU are characterised by requirements derived from Micro Cell scenarios with an IAB-DU to UE minimum distance along the ground equal to 5 m.
- Local Area IAB-DU are characterised by requirements derived from Pico Cell scenarios with an IAB-DU to UE minimum distance along the ground equal to 2 m.

For IAB type 1-H, IAB-DU classes are defined as indicated below:

- Wide Area IAB-DU are characterised by requirements derived from Macro Cell scenarios with an IAB-DU to UE minimum coupling loss equal to 70 dB.
- Medium Range IAB-DU are characterised by requirements derived from Micro Cell scenarios with an IAB-DU to UE minimum coupling loss equals to 53 dB.
- Local Area IAB-DU are characterised by requirements derived from Pico Cell scenarios with an IAB-DU to UE minimum coupling loss equal to 45 dB.

### 4.4.2 IAB-MT classes

The requirements in this specification apply to Wide Area IAB-MT and Local Area IAB-MT classes unless otherwise stated.

For IAB type 1-H, 1-O, and 2-O, IAB-MT classes are defined as indicated below:

- Wide Area IAB-MT are characterised by requirements derived from Macro Cell and/or Micro Cell scenarios.
- Local Area IAB-MT are characterised by requirements derived from Pico Cell and /or Micro Cell scenarios.

## 4.5 Regional requirements

Some requirements in the present document may only apply in certain regions either as optional requirements, or as mandatory requirements set by local and regional regulation. It is normally not stated in the 3GPP specifications under what exact circumstances the regional requirements apply, since this is defined by local or regional regulation.

Table 4.5-1 lists all requirements in the present specification that may be applied differently in different regions.

**Table 4.5-1: List of regional requirements**

Clause number	Requirement	Comments
5.2	<i>Operating bands</i>	Some NR <i>operating bands</i> may be applied regionally.
6.2.3	IAB output power: Additional requirements	These requirements may be applied regionally as additional IAB output power requirements.
6.6.2, 9.7.2	Occupied bandwidth, OTA occupied bandwidth	The requirement may be applied regionally. There may also be regional requirements to declare the occupied bandwidth according to the definition in present specification.
6.6.4.2, 9.7.4.2 9.7.4.3	Operating band unwanted emission, OTA operating band unwanted emissions	Category A or Category B operating band unwanted emissions limits may be applied regionally.
6.6.4.2.5.1, 9.7.4.4.1	Operating band unwanted emission, OTA operating band unwanted emissions: Limits in FCC Title 47	The IAB may have to comply with the additional requirements, when deployed in regions where those limits are applied, and under the conditions declared by the manufacturer.
6.6.5.2.1, 9.7.5.2.2 9.7.5.3.2	Tx spurious emissions, OTA Tx spurious emissions	Category A or Category B spurious emission limits, as defined in ITU-R Recommendation SM.329 [2], may apply regionally. The emission limits for <i>IAB type 1-H</i> and <i>IAB type 1-O</i> specified as the <i>basic limit</i> + X (dB) are applicable, unless stated differently in regional regulation.
6.6.5.2.2, 9.7.5.2.3 9.7.5.3.3	Tx spurious emissions: additional requirements, OTA Tx spurious emissions: additional requirements	These requirements may be applied for the protection of system operating in frequency ranges other than the <i>IAB operating band</i> .
6.7.2.1, 9.8.2	Transmitter intermodulation, OTA transmitter intermodulation	Interfering signal positions that are partially or completely outside of any downlink <i>operating band</i> of the IAB are not excluded from the requirement in Japan in Band n77, n78, n79.
7.6.2, 7.6.3 10.7.2 10.7.3	Rx spurious emissions, OTA Rx spurious emissions	The emission limits for <i>IAB type 1-H</i> and <i>IAB type 1-O</i> specified as the <i>basic limit</i> + X (dB) are applicable, unless stated differently in regional regulation.

## 4.6 Applicability of requirements

In table 4.6-1, the requirement applicability for each *requirement set* of IAB-DUs is defined. In table 4.6-2, the requirement applicability for each *requirement set* of IAB-MTs is defined. For each requirement, the applicable requirement clause in the specification is identified. Requirements not included in a *requirement set* is marked not applicable (NA).

Table 4.6-1: Requirement set applicability for IAB-DUs

Requirement	<i>IAB-DU type 1-H</i>	<i>IAB-DU type 1-O</i>	<i>IAB-DU type 2-O</i>
Output power	6.2	NA	NA
Output power dynamics	6.3		
Transmit ON/OFF power	6.4		
Transmitted signal quality	6.5		
Occupied bandwidth	6.6.2		
ACLR	6.6.3		
Operating band unwanted emissions	6.6.4		
Transmitter spurious emissions	6.6.5		
Transmitter intermodulation	6.7		
Reference sensitivity level	7.2		
Dynamic range	7.3		
In-band selectivity and blocking	7.4		
Out-of-band blocking	7.5		
Receiver spurious emissions	7.6		
Receiver intermodulation	7.7		
In-channel selectivity	7.8		
Performance requirements	8		
Radiated transmit power	9.2	9.2	9.2
OTA Output power	NA	9.3	9.3
OTA output power dynamics		9.4	9.4
OTA transmit ON/OFF power		9.5	9.5
OTA transmitted signal quality		9.6	9.6
OTA occupied bandwidth		9.7.2	9.7.2
OTA ACLR		9.7.3	9.7.3
OTA out-of-band emission		9.7.4	9.7.4
OTA transmitter spurious emission		9.7.5	9.7.5
OTA transmitter intermodulation		9.8	NA
OTA sensitivity		10.2	10.2
OTA reference sensitivity level	NA	10.3	10.3
OTA dynamic range		10.4	NA
OTA in-band selectivity and blocking		10.5	10.5
OTA out-of-band blocking		10.6	10.6
OTA receiver spurious emission		10.7	10.7
OTA receiver intermodulation		10.8	10.8
OTA in-channel selectivity		10.9	10.9
Radiated performance requirements		11	11

Table 4.6-2: Requirement set applicability for IAB-MTs

Requirement	IAB-MT type 1-H	IAB-MT type 1-O	IAB-MT type 2-O
Output power	6.2	NA	NA
Output power dynamics	6.3		
Transmit ON/OFF power	6.4		
Transmitted signal quality	6.5		
Occupied bandwidth	6.6.2		
ACLR	6.6.3		
Operating band unwanted emissions	6.6.4		
Transmitter spurious emissions	6.6.5		
Transmitter intermodulation	6.7		
Reference sensitivity level	7.2		
Dynamic range	NA		
In-band selectivity and blocking	7.4		
Out-of-band blocking	7.5		
Receiver spurious emissions	7.6		
Receiver intermodulation	7.7		
In-channel selectivity	NA		
Performance requirements	8		
Radiated transmit power	9.2	9.2	9.2
OTA Output power	NA	9.3	9.3
OTA output power dynamics		9.4	9.4
OTA transmit ON/OFF power		9.5	9.5
OTA transmitted signal quality		9.6	9.6
OTA occupied bandwidth		9.7.2	9.7.2
OTA ACLR		9.7.3	9.7.3
OTA out-of-band emission		9.7.4	9.7.4
OTA transmitter spurious emission		9.7.5	9.7.5
OTA transmitter intermodulation		9.8	NA
OTA sensitivity		10.2	10.2
OTA reference sensitivity level	NA	10.3	10.3
OTA dynamic range		NA	NA
OTA in-band selectivity and blocking		10.5	10.5
OTA out-of-band blocking		10.6	10.6
OTA receiver spurious emission		10.7	10.7
OTA receiver intermodulation		10.8	NA
OTA in-channel selectivity		NA	NA
Radiated performance requirements		11	11

## 4.7 Applicability of RRM requirements in this specification

### 4.7.1 Applicability of signalling characteristics related RRM requirements

The RRM requirements on the signalling characteristics for IAB MTs specified in section 12.3 shall apply only for the local area IAB class defined in section 4.4.

### 4.7.2 Applicability of RRM requirements in non-DRX

All the RRM requirements for IAB MT specified in section 12 shall apply when no DRX is used. The IAB-MT shall assume that no DRX is used provided the following conditions are met:

- DRX parameters are not configured or
- DRX parameters are configured and



- drx-InactivityTimer is running or
- drx-RetransmissionTimerDL is running or
- drx-RetransmissionTimerUL is running or
- ra-ContentionResolutionTimer is running or
- a Scheduling Request sent on PUCCH is pending or
- a PDCCH indicating a new transmission addressed to the C-RNTI of the MAC entity has not been received after successful reception of a Random Access Response for the preamble not selected by the MAC entity

## 4.8 Requirements for contiguous and non-contiguous spectrum

A spectrum allocation where an IAB-DU or IAB-MT operates can either be contiguous or non-contiguous. Unless otherwise stated, the requirements in the present specification apply for IAB-DU and IAB-MT configured for both *contiguous spectrum* operation and *non-contiguous spectrum* operation.

For IAB-DU or IAB-MT operation in *non-contiguous spectrum*, some requirements apply both at the *IAB-DU RF Bandwidth edges* or *IAB-MT RF Bandwidth edges*, and inside the *sub-block gaps*. For each such requirement, it is stated how the limits apply relative to the *IAB-DU RF Bandwidth edges* and *IAB-MT RF Bandwidth edges* and the *sub-block edges* respectively.

## 4.9 Requirements for IAB-DU and IAB-MT capable of multi-band operation

For *multi-band connector* or *multi-band RIB*, the RF requirements in clause 6, 7, 9 and 10 apply separately to each supported *operating band* unless otherwise stated. For some requirements, it is explicitly stated that specific additions or exclusions to the requirement apply at *multi-band connector(s)*, and *multi-band RIB(s)* as detailed in the requirement clause. For *IAB-DU* or *IAB-MT* capable of multi-band operation, various structures in terms of combinations of different transmitter and receiver implementations (multi-band or single band) with mapping of transceivers to one or more *TAB connectors* for *IAB-DU* or *IAB-MT type 1-H* in different ways are possible. For *multi-band connector(s)* the exclusions or provisions for multi-band apply. For *single-band connector(s)*, the following applies:

- Single-band transmitter spurious emissions, *operating band* unwanted emissions, ACLR, transmitter intermodulation and receiver spurious emissions requirements apply to this *connector* that is mapped to single-band.
- If the IAB-DU or IAB-MT is configured for single-band operation, single-band requirements shall apply to this *connector* configured for single-band operation and no exclusions or provisions for multi-band capable *IAB-DU* or *IAB-MT* are applicable. Single-band requirements are tested separately at the *connector* configured for single-band operation, with all other *antenna connectors* terminated.

A *IAB-DU* or *IAB-MT type 1-H* may be capable of supporting operation in multiple *operating bands* with one of the following implementations of *TAB connectors* in the *transceiver array boundary*:

- All *TAB connectors* are *single-band connectors*.
- Different sets of *single-band connectors* support different *operating bands*, but each *TAB connector* supports only operation in one single *operating band*.
- Sets of *single-band connectors* support operation in multiple *operating bands* with some *single-band connectors* supporting more than one *operating band*.
- All *TAB connectors* are multi-band *connectors*.
- A combination of single-band sets and multi-band sets of *TAB connectors* provides support of the type *IAB-DU type 1-H* capability of operation in multiple *operating bands*.

Unless otherwise stated all requirements specified for an *operating band* apply only to the set of *TAB connectors* supporting that *operating band*.

In the case of an *operating band* being supported only by *single-band connectors* in a *TAB connector TX min cell group* or a *TAB connector RX min cell group*, *single-band requirements* apply to that set of *TAB connectors*.

In the case of an *operating band* being supported only by *multi-band connectors* supporting the same *operating band* combination in a *TAB connector TX min cell group* or a *TAB connector RX min cell group*, *multi-band requirements* apply to that set of *TAB connectors*.

The case of an *operating band* being supported by both *multi-band connectors* and *single-band connectors* in a *TAB connector TX min cell group* or a *TAB connector RX min cell group* is not covered by the present release of this specification.

The case of an *operating band* being supported by *multi-band connectors* which are not all supporting the same *operating band* combination in a *TAB connector TX min cell group* or a *TAB connector RX min cell group* is not covered by the present release of this specification.

*IAB-DU* or *IAB-MT type 1-O* may be capable of supporting operation in multiple *operating bands* with one of the following implementations at the *radiated interface boundary*:

- All RIBs are *single-band RIBs*.
- All RIBs are *multi-band RIBs*.
- A combination of *single-band RIBs* and *multi-band RIBs* provides support of the *IAB-DU* or *IAB-MT type 1-O* capability of operation in multiple *operating bands*.

For *multi-band connectors* and *multi-band RIBs* supporting the bands for TDD, the RF requirements in the present specification assume no simultaneous uplink and downlink occur between the bands.

## 4.10 OTA co-location with other base stations

Co-location requirements are requirements which are based on assuming the *IAB-DU* or *IAB-MT type 1-O* is co-located with another BS or IAB of the same base station class, they ensure that both co-located systems can operate with minimal degradation to each other.

Unwanted emission and out of band blocking co-location requirements are optional requirements based on declaration. TX OFF and TX IMD are mandatory requirements and have the form of a co-location requirement as it represents the worst-case scenario of all the interference cases.

NOTE: Due to the low level of the unwanted emissions for the spurious emissions and TX OFF level co-location is the most suitable method to show conformance.

The *co-location reference antenna* shall be a single column passive antenna which has the same vertical radiating dimension (h), frequency range, polarization, as the composite antenna of the *IAB-DU* or *IAB-MT type 1-O* and nominal 65° horizontal half-power beamwidth (suitable for 3-sector deployment) and is placed at a distance *d* from the edge of the *IAB-DU* or *IAB-MT type 1-O*, as shown in figure 4.10-1.

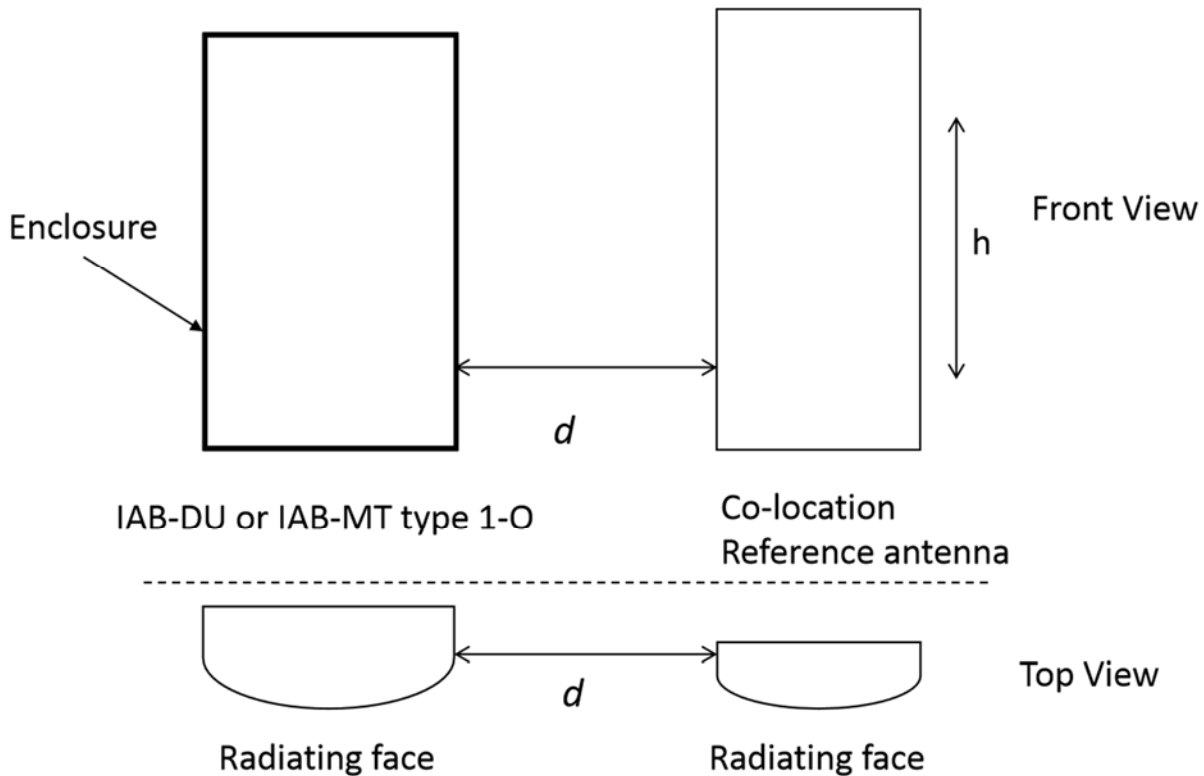

**Figure 4.10-1: Illustration of *IAB-DU* and *IAB-MT type 1-O* enclosure and co-location reference antenna**

Edge-to-edge separation  $d$  between the *IAB-DU* or *IAB-MT type 1-O* and the *co-location reference antenna* shall be set to 0.1 m.

The *IAB-DU* or *IAB-MT type 1-O* and the *co-location reference antenna* shall be aligned in a common plane perpendicular to the mechanical bore-sight direction, as shown in figure 4.10-1.

The *co-location reference antenna* and the *IAB-DU* or *IAB-MT type 1-O* can have different width.

The vertical radiating regions of the *co-location reference antenna* and the *IAB-DU* or *IAB-MT type 1-O* composite antenna shall be aligned.

For co-location requirements where the frequency range of the signal at the *co-location reference antenna* is different from the *IAB-DU* or *IAB-MT type 1-O*, a *co-location reference antenna* suitable for the frequency stated in the requirement is assumed.

OTA co-location requirements are based on the power at the conducted interface of a *co-location reference antenna*, depending on the requirement this interface is either an input or an output. For *IAB-DU* or *IAB-MT type 1-O* with dual polarization the *co-location reference antenna* has two conducted interfaces each representing one polarization.

## 4.11 Requirements for IAB-DU and IAB-MT capable of simultaneous operation

IAB-DU and IAB-MT can be configured as *IAB Simultaneous Operation* based on declaration. Unless otherwise stated, the requirements in the present specification apply for IAB-MT and IAB-DU of IAB-node configured as *IAB Simultaneous Operation*.

For IAB-node in *IAB Simultaneous Operation*, as detailed in the requirement clause, transmitter requirements apply whatever the type of transmitter considered and for all transmission modes foreseen by the manufacturer's specification as detailed in the requirement clause.

NOTE: For IAB node operating as simultaneous transmission of IAB-DU and IAB-MT, the manufacturer can provide different declarations for verification on Modulation quality and ACLR according to the conformance specification declaration requirements.

For IAB-node in *IAB Simultaneous Operation*, as detailed in the requirement clause, receiver requirements shall be met for any transmitter setting unless otherwise stated.

## 5 Operating bands and channel arrangement

### 5.1 General

The channel arrangements presented in this clause are based on the *operating bands* and *IAB-DU or IAB-MT channel bandwidths* defined in the present release of specifications.

NOTE: Other *operating bands* and *IAB-DU or IAB-MT channel bandwidths* may be considered in future releases.

Requirements throughout the RF specifications are in many cases defined separately for different frequency ranges (FR). The frequency ranges in which NR can operate according to the present version of the specification are identified as described in table 5.1-1.

**Table 5.1-1: Definition of frequency ranges**

Frequency range designation		Corresponding frequency range
FR1		410 MHz – 7125 MHz
FR2	FR2-1	24250 MHz – 52600 MHz
	FR2-2	52600 MHz – 71000 MHz

### 5.2 Operating bands

NR IAB is designed to operate in the *operating bands* in FR1 defined in table 5.2-1 and operating bands in FR2-1 defined in 38.104 [2].

**Table 5.2-1 NR IAB operating bands in FR1**

NR operating band	Uplink (UL) operating band BS receive / UE transmit $F_{UL,low}$ – $F_{UL,high}$	Downlink (DL) operating band BS transmit / UE receive $F_{DL,low}$ – $F_{DL,high}$	Duplex Mode
n41	2496 MHz – 2690 MHz	2496 MHz – 2690 MHz	TDD
n77	3300 MHz – 4200 MHz	3300 MHz – 4200 MHz	TDD
n78	3300 MHz – 3800 MHz	3300 MHz – 3800 MHz	TDD
n79	4400 MHz – 5000 MHz	4400 MHz – 5000 MHz	TDD

### 5.3 Channel bandwidth

#### 5.3.1 General

The IAB-DU channel bandwidth supports a single NR RF carrier in the uplink or downlink at the IAB node. Different UE or IAB-MT channel bandwidths may be supported within the same spectrum for transmitting to and receiving from UEs or IAB-MT connected to the IAB-DU. The placement of the UE or IAB-MT channel bandwidth is flexible but can only be completely within the IAB-DU channel bandwidth. The IAB-DU shall be able to transmit to and/or receive from one or more UE or IAB-MT Bandwidth parts that are smaller than or equal to the number of carrier resource blocks on the RF carrier, in any part of the carrier resource blocks.

The IAB-MT channel bandwidth supports a single NR RF carrier in the uplink or downlink at the IAB-MT. From a BS or IAB-DU perspective, different IAB-MT channel bandwidths may be supported within the same spectrum for transmitting to and receiving from UEs or IAB-MT connected to the IAB-DU. Transmission of multiple carriers to the same IAB-MT (CA) or multiple carriers to different UEs or IAB-MT within the IAB-DU channel bandwidth can be supported.

From a IAB-MT perspective, the IAB-MT is configured with one or more BWP / carriers, each with its own IAB-MT channel bandwidth. The IAB-MT does not need to be aware of the BS or IAB-DU channel bandwidth or how the BS or IAB-DU allocates bandwidth to different UEs or IAB-MT.

The placement of the IAB-MT channel bandwidth for each IAB-MT carrier is flexible but can only be completely within the IAB-donor or IAB-DU channel bandwidth.

The relationship between the IAB-DU or IAB-MT channel bandwidth, the guardband and the transmission bandwidth configuration is shown in Figure 5.3.1-1.

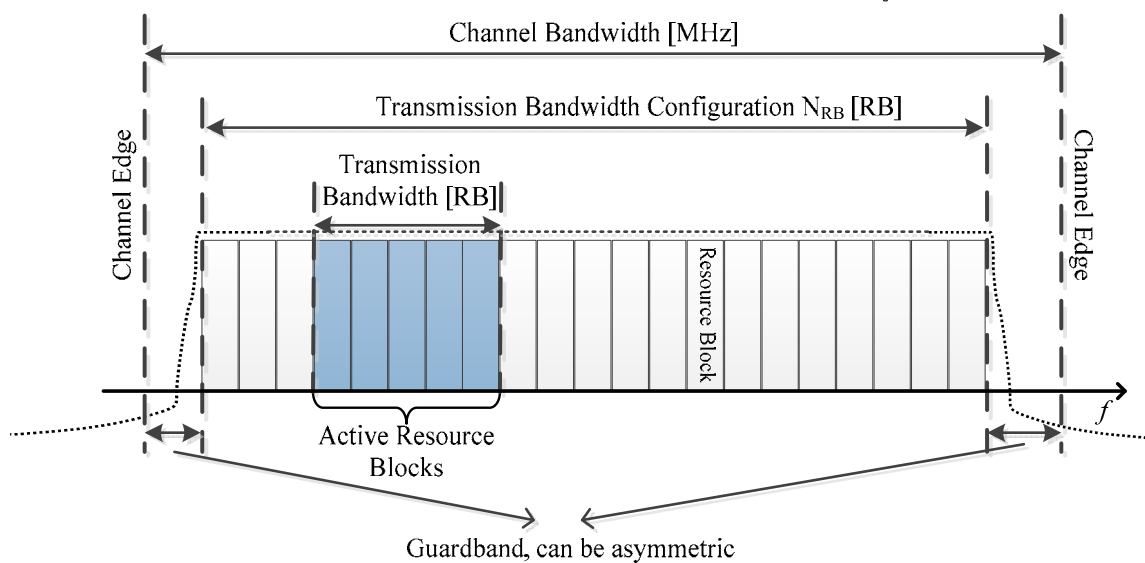

**Figure 5.3.1-1: Definition of channel bandwidth and transmission bandwidth configuration for one NR channel**

### 5.3.2 Transmission bandwidth configuration

For IAB-DU, the transmission bandwidth configuration is the same as specified for BS in TS 38.104 [2], subclause 5.3.2.

For IAB-MT, the transmission bandwidth configuration is the same as specified for UE in TS 38.101-1 [3] for FR1 in subclause 5.3.2 and in TS 38.101-2 [4] for FR2-1 in subclause 5.3.2.

### 5.3.3 Minimum guardband and transmission bandwidth configuration

For IAB-DU, the minimum guardband and transmission bandwidth configuration is the same as specified for BS in TS38.104 [2], subclause 5.3.3.

For IAB-MT, the minimum guardband and transmission bandwidth configuration is the same as specified for UE in TS38.101-1 [3] for FR1 and in TS 38.101-2 [4] for FR2-1 in subclause 5.3.3.

### 5.3.4 RB alignment

For each *IAB-DU channel bandwidth* and each numerology, *IAB-DU transmission bandwidth configuration* must fulfil the minimum guardband requirement specified in clause 5.3.3.

For IAB-DU, for each numerology, its common resource blocks are specified in clause 4.4.4.3 in [7], and the starting point of its *transmission bandwidth configuration* on the common resource block grid for a given channel bandwidth is indicated by an offset to “Reference point A” in the unit of the numerology.

For IAB-DU, for each numerology, all *UE and IAB-MT transmission bandwidth configurations* indicated to UEs or IAB-MT served by the IAB-DU by higher layer parameter *carrierBandwidth* defined in TS 38.331 [15] shall fall within the *IAB-DU transmission bandwidth configuration*.

For IAB-MT, the RB alignment is the same as specified for UE in TS38.101-1 [3] for FR1 in subclause 5.3.4 and in TS 38.101-2 [4] for FR2-1 in subclause 5.3.4.

### 5.3.5 IAB-DU and IAB-MT channel bandwidth per operating band

For IAB-DU, the channel bandwidth for NR bands for FR1 in Table 5.2.1 and for NR bands for FR2-1 defined in TS38.104 [2] is the same as specified for BS in TS38.104 [2], subclause 5.3.5.

For IAB-MT, the channel bandwidth for NR bands for FR1 in Table 5.2-1 is the same as specified for UE in TS38.101-1 [3] in subclause 5.3.5 and for NR bands for FR2-1 defined in TS38.104 [2] is the same as specified for UE in TS38.101-2 [4] in subclause 5.3.5.

## 5.3A IAB-DU and IAB-MT channel bandwidth for CA

The IAB-DU and IAB-MT channel bandwidth for CA is the same as specified for BS in TS38.104 [2], subclause 5.3A.

## 5.4 Channel arrangement

### 5.4.1 Channel spacing

For IAB-DU, the channel spacing is the same as specified for BS in TS38.104 [2], subclause 5.4.1.

For IAB-MT, the channel spacing is the same as specified for UE in TS38.101-1 [3] for FR1 in subclause 5.4.1 and in TS38.101-2 [4] for FR2-1 in subclause 5.4.1.

### 5.4.2 Channel raster

#### 5.4.2.1 NR-ARFCN and channel raster

For IAB-DU, the NR-ARFCN and channel raster is the same as specified for BS in TS38.104 [2], subclause 5.4.2.1.

For IAB-MT, the NR-ARFCN and channel raster is the same as specified for UE in TS38.101-1 [3] for FR1 in subclause 5.4.2.1 and in TS38.101-2 [4] for FR2-1 in subclause 5.4.2.1.

#### 5.4.2.2 Channel raster to resource element mapping

For IAB-DU, the Channel raster to resource element mapping is the same as specified for BS in TS38.104 [2], subclause 5.4.2.2.

For IAB-MT, the Channel raster to resource element mapping is the same as specified for UE in TS38.101-1 [3] for FR1 in subclause 5.4.2.2 and in TS38.101-2 [4] for FR2-1 in subclause 5.4.2.2.

### 5.4.2.3 Channel raster entries for each *operating band*

For IAB-DU, the channel raster entries for NR bands for FR1 in Table 5.2-1 and NR bands for FR2-1 defined in TS38.104 [2] are the same as specified for BS in TS38.104 [2], subclause 5.4.2.3.

For IAB-MT, the channel raster entries for NR bands for FR1 in Table 5.2-1 are the same as specified for UE in TS38.101-1 [3] in subclause 5.4.2.3 and for NR bands for FR2-1 defined in TS38.104 [2] are the same as specified for UE in TS38.101-2 [4] in subclause 5.4.2.3.

## 5.4.3 Synchronization raster

### 5.4.3.1 Synchronization raster and numbering

For IAB-DU, the synchronization raster and numbering are the same as specified for BS in TS38.104 [2], subclause 5.4.3.1.

For IAB-MT, the synchronization raster and numbering are the same as specified for UE in TS38.101-1 [3] for FR1 in subclause 5.4.3.1 and in TS38.101-2 [4] for FR2-1 in subclause 5.4.3.1.

### 5.4.3.2 Synchronization raster to synchronization block resource element mapping

For IAB-DU, the synchronization raster to synchronization block resource element mapping is the same as specified for BS in TS38.104 [2], subclause 5.4.3.2.

For IAB-MT, the synchronization raster to synchronization block resource element mapping is the same as specified for UE in TS38.101-1 [3] for FR1 in subclause 5.4.3.2 and in TS38.101-2 [4] for FR2-1 in subclause 5.4.3.2.

### 5.4.3.3 Synchronization raster entries for each operating band

For IAB-DU, the synchronization raster entries for NR bands for FR1 in Table 5.2-1 and for NR bands for FR2-1 defined in TS38.104 [2] are the same as specified for BS in TS38.104 [2], subclause 5.4.3.3.

For IAB-MT, the synchronization raster entries for NR bands for FR1 in Table 5.2-1 are the same as specified for UE in TS38.101-1 [3] in subclause 5.4.3.3 and for NR bands for FR2-1 defined in TS38.104 [2] are the same as specified for UE in TS38.101-2 [4] in subclause 5.4.3.3.

---

## 6 Conducted transmitter characteristics

### 6.1 General

Unless otherwise stated, the conducted transmitter characteristics are specified at the *TAB connector* for *IAB-DU* and *IAB-MT type 1-H*, with a full complement of transceiver units for the configuration in normal operating conditions.

For *IAB-DU* and *IAB-MT type 1-H* the manufacturer shall declare the minimum number of supported geographical cells (i.e. geographical areas covered by beams). The declaration is done separately for *IAB-DU* and *IAB-MT*. The minimum number of supported geographical cells ( $N_{\text{cells}}$ ) relates to the setting with the minimum amount of cell splitting supported with transmission on all *TAB connectors* supporting the *operating band*, or with minimum amount of transmitted beams.

For *IAB-DU* and *IAB-MT type 1-H* manufacturer shall also declare *TAB connector TX min cell groups*. The declaration is done separately for *IAB-DU* and *IAB-MT*. Every *TAB connector* of the *IAB-DU type 1-H* and *IAB-MT type 1-H* supporting transmission in an *operating band* shall map to one *TAB connector TX min cell group* supporting the same *operating band*, where mapping of *TAB connectors* to cells/beams is implementation dependent.

The number of *active transmitter units* that are considered when calculating the conducted TX emissions limits ( $N_{\text{TXU,counted}}$ ) for *IAB-DU* and *IAB-MT type 1-H* is calculated as follows:

$$N_{\text{TXU,counted}} = \min(N_{\text{TXU,active}}, 8 \times N_{\text{cells}})$$

$N_{\text{TXU, countedpercell}}$  is used for scaling of *basic limits* and is derived as  $N_{\text{TXU, countedpercell}} = N_{\text{TXU, counted}} / N_{\text{cells}}$

NOTE:  $N_{\text{TXU, active}}$  depends on the actual number of *active transmitter units* and is independent to the declaration of  $N_{\text{cells}}$ .

## 6.2 IAB output power

### 6.2.1 General

The IAB type 1-H conducted output power requirement is at *TAB connector* for *IAB type 1-H*.

The *rated carrier output power* of the *IAB type 1-H* shall be as specified in table 6.2.1-1 for *IAB-DU type 1-H* and in table 6.2.1-2 for *IAB-MT type 1-H*.

**Table 6.2.1-1: IAB-DU type 1-H rated output power limits for IAB-DU classes**

IAB-DU class	$P_{\text{rated, c, sys}}$	$P_{\text{rated, c, TABC}}$
Wide Area IAB-DU	(Note)	(Note)
Medium Range IAB-DU	$\leq 38 \text{ dBm} + 10\log(N_{\text{TXU, counted}})$	$\leq 38 \text{ dBm}$
Local Area IAB-DU	$\leq 24 \text{ dBm} + 10\log(N_{\text{TXU, counted}})$	$\leq 24 \text{ dBm}$
NOTE: There is no upper limit for the $P_{\text{rated, c, sys}}$ or $P_{\text{rated, c, TABC}}$ of the Wide Area IAB-DU.		

**Table 6.2.1-2: IAB-MT type 1-H rated output power limits for IAB-MT classes**

IAB-MT class	$P_{\text{rated, c, sys}}$	$P_{\text{rated, c, TABC}}$
Wide Area IAB-MT	(Note)	(Note)
Local Area IAB-MT	$\leq 24 \text{ dBm} + 10\log(N_{\text{TXU, counted}})$	$\leq 24 \text{ dBm}$
NOTE: There is no upper limit for the $P_{\text{rated, c, sys}}$ or $P_{\text{rated, c, TABC}}$ of the Wide area IAB-MT.		

### 6.2.2 Minimum requirement for IAB type 1-H

In normal conditions,  $P_{\text{max, c, TABC}}$  shall remain within +2 dB and -2 dB of the *rated carrier output power*  $P_{\text{rated, c, TABC}}$  for each *TAB connector* as declared by the manufacturer.

In extreme conditions,  $P_{\text{max, c, TABC}}$  shall remain within +2.5 dB and -2.5 dB of the *rated carrier output power*  $P_{\text{rated, c, TABC}}$  for each *TAB connector* as declared by the manufacturer.

In certain regions, the minimum requirement for normal conditions may apply also for some conditions outside the range of conditions defined as normal.

### 6.2.3 Additional requirements (regional)

In certain regions, additional regional requirements may apply.

## 6.3 Output power dynamics

### 6.3.1 IAB-DU Output Power Dynamics

#### 6.3.1.1 General

The requirements in clause 6.3 apply during the *transmitter ON period*. Transmitted signal quality (as specified in clause 6.5) shall be maintained for the output power dynamics requirements of this clause.

Power control is used to limit the interference level.



## 6.3.1.2 RE power control dynamic range

### 6.3.1.2.1 General

The RE power control dynamic range is the difference between the power of an RE and the average RE power for a IAB-DU at maximum output power ( $P_{\max,c,TABC}$ ) for a specified reference condition.

For *IAB-DU type 1-H* this requirement shall apply at each *TAB connector* supporting transmission in the *operating band*.

### 6.3.1.2.2 Minimum requirement for *IAB-DU type 1-H*

The RE power control dynamic range is specified the same as the conducted RE power control dynamic range requirement for BS *type 1-H* in TS 38.104 [2], subclause 6.3.2.2.

## 6.3.1.3 Total power dynamic range

### 6.3.1.3.1 General

The IAB-DU total power dynamic range is the difference between the maximum and the minimum transmit power of an OFDM symbol for a specified reference condition.

For *IAB-DU type 1-H* this requirement shall apply at each *TAB connector* supporting transmission in the *operating band*.

NOTE: The upper limit of the dynamic range is the OFDM symbol power for a BS when transmitting on all RBs at maximum output power. The lower limit of the total power dynamic range is the average power for single RB transmission. The OFDM symbol shall carry PDSCH and not contain RS or SSB.

### 6.3.1.3.2 Minimum requirement for *IAB-DU type 1-H*

The total power dynamic range is specified the same as the total power dynamic range requirement for BS *type 1-H* in TS 38.104 [2], subclause 6.3.3.2, where references to *BS channel bandwidth* apply to *IAB-DU channel bandwidth*.

## 6.3.2 IAB-MT Output Power Dynamics

### 6.3.2.1 Total power dynamic range

#### 6.3.2.1.1 General

The IAB-MT total power dynamic range is the difference between the maximum and the minimum controlled transmit power in the channel bandwidth for a specified reference condition. The maximum and minimum output powers are defined as the mean power in at least one sub-frame 1ms.

NOTE: The specified reference condition(s) are specified in the conformance specification Changes in the controlled transmit power in the channel bandwidth due to changes in the specified reference condition are not included as part of the dynamic range.

#### 6.3.2.1.2 Minimum requirement for *IAB-MT type 1-H*

For a wide area IAB-MT the total power dynamic range for each NR carrier shall be larger than or equal to 5 dB.

For a local area IAB-MT the total power dynamic range for each NR carrier shall be larger than or equal to 10 dB.

## 6.3.3 Power control

### 6.3.3.1 Relative power tolerance for local area IAB-MT type 1-H

The relative power tolerance is the ability of the transmitter to set its output power in a target sub-frame (1 ms) relatively to the power of the most recently transmitted reference sub-frame (1 ms) if the transmission gap between these sub-frames is less than or equal to 20 ms.

The minimum requirements specified for each *TAB-connector* in Table 6.3.3.1-1 apply only when the output power is within the limits set by declared maximum output power and specified dynamic range.

2 exceptions are allowed for each of two test patterns. The test patterns are a monotonically increasing power sweep and a monotonically decreasing power sweep. For those exceptions, the power tolerance limit is a maximum of  $[\pm 6.0 \text{ dB}]$  in Table 6.3.3.1-1.

**Table 6.3.3.1-1: Relative power tolerance**

Power step $\Delta P$ (Up or down) (dB)	Power tolerance (dB)
$\Delta P < 2$	$[\pm 2.5]$
$2 \leq \Delta P < 3$	$[\pm 3.5]$
$3 \leq \Delta P < 4$	$[\pm 4.5]$
$4 \leq \Delta P < 10$	$[\pm 5.5]$

### 6.3.3.2 Aggregate power tolerance for local area IAB-MT type 1-H

The aggregate power control tolerance is the ability of the transmitter to maintain its power in a sub-frame (1 ms) during non-contiguous transmissions within [21 ms] in response to 0 dB commands with respect to the first transmission and all other power control parameters as specified in 3GPP TS 38.213 [10] kept constant.

The minimum requirements specified for each *TAB-connector* in Table 6.3.3.2-1 apply only when the output power is within the limits set by declared maximum output power and specified dynamic range.

**Table 6.3.3.2-1: Aggregate power tolerance**

TPC command	UL channel	Aggregate power tolerance within [21 ms]
0 dB	PUCCH	$[\pm 2.5 \text{ dB}]$
0 dB	PUSCH	$[\pm 3.5 \text{ dB}]$

## 6.4 Transmit ON/OFF power

### 6.4.1 Transmitter OFF power

#### 6.4.1.1 General

Transmit OFF power requirements apply to TDD operation of IAB-DU and TDD operation of IAB-MT.

Transmitter OFF power is defined as the mean power measured over  $70/N$  us filtered with a square filter of bandwidth equal to the *transmission bandwidth configuration* of the IAB ( $BW_{\text{Config}}$ ) centred on the assigned channel frequency during the *transmitter OFF period*.  $N = \text{SCS}/15$ , where SCS is Sub Carrier Spacing in kHz.

For IAB-DU and IAB-MT, for *multi-band connectors* and for *single band connectors* supporting transmission in multiple *operating bands*, the requirement is only applicable during the *transmitter OFF period* in all supported *operating bands*.

For IAB supporting intra-band contiguous CA, the transmitter OFF power is defined as the mean power measured over  $70/N$  us filtered with a square filter of bandwidth equal to the *Aggregated IAB-DU Channel Bandwidth* or *IAB-MT Channel Bandwidth*  $BW_{\text{Channel\_CA}}$  centred on  $(F_{\text{edge,high}} + F_{\text{edge,low}})/2$  during the *transmitter OFF period*.  $N = \text{SCS}/15$ ,

where SCS is the smallest supported Sub Carrier Spacing in kHz in the *Aggregated IAB-DU (IAB-MT) Channel Bandwidth*.

### 6.4.1.3 Minimum requirement for *IAB-DU type 1-H*

The BS requirements specified in 6.4.1.3 in TS 38.104 [2] apply to *IAB-DU type 1-H*.

### 6.4.1.4 Minimum requirement for *IAB-MT type 1-H*

The BS requirements specified in 6.4.1.3 in TS 38.104 [2] apply to *IAB-MT type 1-H*.

## 6.4.2 Transmitter transient period

### 6.4.2.1 General

Transmitter transient period requirements apply to TDD operation of IAB-DU and TDD operation of IAB-MT.

The transmitter transient period is the time period during which the transmitter is changing from the transmitter OFF period to the transmitter ON period or vice versa. The transmitter transient period is illustrated in figure 6.4.2.1-1 for IAB-DU and IAB-MT.

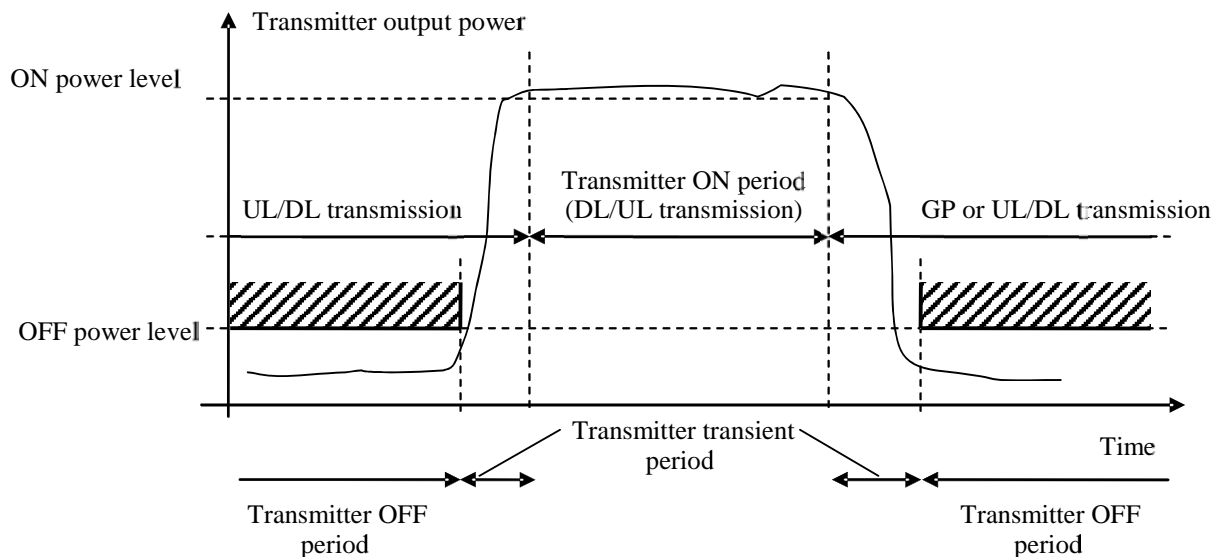

**Figure 6.4.2.1-1: Example of relations between transmitter ON period, transmitter OFF period and transmitter transient period for IAB-DU and IAB-MT**

For IAB-DU type 1-H and IAB-MT type 1-H, this requirement shall be applied at each TAB connector supporting transmission in the operating band.

### 6.4.2.2 Minimum requirement for IAB-DU type 1-H

The BS requirements specified in clause 6.4.2.2 in TS 38.104 [2] apply to IAB-DU type 1-H.

### 6.4.2.3 Minimum requirement for IAB-MT type 1-H

The BS requirements specified in clause 6.4.2.2 in TS 38.104 [2] apply to IAB-MT type 1-H.

## 6.5 Transmitted signal quality

### 6.5.1 Frequency error

#### 6.5.1.1 IAB-DU frequency error

The requirements in clause 6.5.1 for BS type 1-H in TS 38.104 [2] apply to IAB-DU type 1-H.

#### 6.5.1.2 IAB-MT frequency error

The IAB-MT basic measurement interval of modulated carrier frequency is 1 UL slot. The mean value of basic measurements of IAB-MT modulated carrier frequency shall be accurate to within  $\pm 0.1$  PPM observed over a period of 1 ms of cumulated measurement intervals compared to the carrier frequency received from the parent node.

### 6.5.2 Modulation quality

#### 6.5.2.1 IAB-DU modulation quality

The requirements in clause 6.5.2 for BS type 1-H in TS 38.104 [2] apply to IAB-DU type 1-H.

NOTE: When the indicated IAB-MT transmission timing mode is set to ‘Case6’ as specified in 3GPP TS 38.213 [10], the power imbalance for simultaneous transmission between IAB-DU and IAB-MT under which the system can be operated is declared by manufacturer.

#### 6.5.2.2 IAB-MT modulation quality

##### 6.5.2.2.1 General

Modulation quality is defined by the difference between the measured carrier signal and an ideal signal. Modulation quality can e.g. be expressed as Error Vector Magnitude (EVM). The Error Vector Magnitude is a measure of the difference between the ideal symbols and the measured symbols after the equalization. This difference is called the error vector. Details about how the EVM is determined are specified in Annex D.

For IAB-MT type 1-H this requirement shall be applied at each TAB connector supporting transmission in the operating band.

##### 6.5.2.2.2 Minimum requirements for IAB-MT type 1-H

For *IAB-MT type 1-H*, the EVM levels of each NR carrier for different modulation schemes outlined in table 6.5.2.2.2-1 shall be met using the frame structure described in clause 6.5.2.2.3.

**Table 6.5.2.2.2-1: Requirements for Error Vector Magnitude**

Parameter	Unit	Average EVM Level
QPSK	%	17.5
16 QAM	%	12.5
64 QAM	%	8
256 QAM	%	3.5

NOTE: When the indicated IAB-MT transmission timing mode is set to ‘Case6’ as specified in 3GPP TS 38.213 [10], the power imbalance for simultaneous transmission between IAB-DU and IAB-MT under which the system can be operated is declared by manufacturer.

### 6.5.2.2.3 EVM frame structure for measurement

EVM shall be evaluated for each NR carrier over all allocated resource blocks and uplink subframes for IAB-MT. Different modulation schemes listed in Table 6.5.2.2.2-1 shall be considered for rank 1.

For NR, for all bandwidths, the EVM measurement shall be performed for each NR carrier over all allocated resource blocks and uplink subframes within 10 ms measurement periods. The boundaries of the EVM measurement periods need not be aligned with radio frame boundaries.

## 6.5.3 Time alignment error

### 6.5.3.1 IAB-DU time alignment error

The requirements in clause 6.5.3 for BS type 1-H in TS 38.104 [2] apply to IAB-DU type 1-H.

## 6.5.4 Timing error between IAB-DU and IAB-MT of the same IAB-Node

When the indicated IAB-MT transmission timing mode is set to 'Case6' as specified in 3GPP TS 38.213 [10] and IAB-DU and IAB-MT of the same IAB-Node are transmitting simultaneously, the timing error between transmission timing of IAB-DU and IAB-MT shall not exceed  $3\mu\text{s}$ .

## 6.6 Unwanted emissions

### 6.6.1 General

Unwanted emissions consist of out-of-band emissions and spurious emissions according to ITU definitions [16]. In ITU terminology, out of band emissions are unwanted emissions immediately outside the channel bandwidth resulting from the modulation process and non-linearity in the transmitter but excluding spurious emissions. Spurious emissions are emissions which are caused by unwanted transmitter effects such as harmonics emission, parasitic emission, intermodulation products and frequency conversion products, but exclude out of band emissions.

The out-of-band emissions requirement for the IAB-DU and IAB-MT transmitter is specified both in terms of Adjacent Channel Leakage power Ratio (ACLR) and *operating band* unwanted emissions (OBUE).

The maximum offset of the *operating band* unwanted emissions mask from the *operating band* edge is  $\Delta f_{\text{OBUE}}$ . The Operating band unwanted emissions define all unwanted emissions in each supported downlink *operating band* of IAB-DU and uplink *operating band* of IAB-MT, plus the frequency ranges  $\Delta f_{\text{OBUE}}$  above and  $\Delta f_{\text{OBUE}}$  below each band. Unwanted emissions outside of this frequency range are limited by a spurious emissions requirement.

The values of  $\Delta f_{\text{OBUE}}$  are defined in tables 6.6.1-1 and 6.6.1-2 for the NR *operating bands*.

**Table 6.6.1-1: Maximum offset of OBUE outside the downlink *operating band* of IAB-DU**

IAB-DU type	Operating band characteristics	$\Delta f_{\text{OBUE}}$ (MHz)
IAB-DU type 1-H	$F_{\text{DL,high}} - F_{\text{DL,low}} < 100 \text{ MHz}$	10
	$100 \text{ MHz} \leq F_{\text{DL,high}} - F_{\text{DL,low}} \leq 900 \text{ MHz}$	40

**Table 6.6.1-2: Maximum offset of OBUE outside the uplink *operating band* of IAB-MT**

IAB-MT type	Operating band characteristics	$\Delta f_{\text{OBUE}}$ (MHz)
IAB-MT type 1-H	$F_{\text{UL,high}} - F_{\text{UL,low}} < 100 \text{ MHz}$	10
	$100 \text{ MHz} \leq F_{\text{UL,high}} - F_{\text{UL,low}} \leq 900 \text{ MHz}$	40

For IAB-DU type 1-H and IAB-MT type 1-H the unwanted emission requirements are applied per the TAB connector TX min cell groups for all the supported configurations. The *basic limits* and corresponding emissions scaling are defined in each relevant clause.

There is in addition a requirement for occupied bandwidth.

## 6.6.2 Occupied bandwidth

### 6.6.2.1 General

The occupied bandwidth is the width of a frequency band such that, below the lower and above the upper frequency limits, the mean powers emitted are each equal to a specified percentage  $\beta/2$  of the total mean transmitted power. See also Recommendation ITU-R SM.328 [19].

The value of  $\beta/2$  shall be taken as 0.5%.

The occupied bandwidth requirement shall apply during the *transmitter ON period* for a single transmitted carrier. The minimum requirement below may be applied regionally. There may also be regional requirements to declare the occupied bandwidth according to the definition in the present clause.

For *IAB-DU type 1-H* and *IAB-MT type 1-H* this requirement shall be applied at each *TAB connector* supporting transmission in the *operating band*.

### 6.6.2.2 Minimum requirement for *IAB-DU type 1-H*

The occupied bandwidth for each NR carrier shall be less than the *IAB-DU channel bandwidth*. For intra-band contiguous CA, the occupied bandwidth shall be less than or equal the *Aggregated IAB-DU Channel Bandwidth*.

### 6.6.2.3 Minimum requirement for *IAB-MT type 1-H*

The occupied bandwidth for each NR carrier shall be less than the *IAB-MT channel bandwidth*. For intra-band contiguous CA, the occupied bandwidth shall be less than or equal the *Aggregated IAB-MT Channel Bandwidth*.

## 6.6.3 Adjacent Channel Leakage Power Ratio

### 6.6.3.1 General

Adjacent Channel Leakage power Ratio (ACLR) is the ratio of the filtered mean power centred on the assigned channel frequency to the filtered mean power centred on an adjacent channel frequency.

The requirements shall apply outside the *IAB-DU RF Bandwidth*, *IAB-MT RF Bandwidth* or *Radio Bandwidth* whatever the type of transmitter considered (single carrier or multi-carrier) and for all transmission modes foreseen by the manufacturer's specification.

For an *IAB-Node* operating in *non-contiguous spectrum*, the ACLR requirement in clause 6.6.3.2 shall apply in *sub-block gaps* for the frequency ranges defined in table 6.6.3.2-3, while the CACLR requirement in clause 6.6.3.2 shall apply in *sub-block gaps* for the frequency ranges defined in table 6.6.3.2-4.

For a *multi-band connector*, the ACLR requirement in clause 6.6.3.2 shall apply in *Inter RF Bandwidth gaps* for the frequency ranges defined in table 6.6.3.2-3, while the CACLR requirement in clause 6.6.3.2 shall apply in *Inter RF Bandwidth gaps* for the frequency ranges defined in table 6.6.3.2-4.

The requirement shall apply during the *transmitter ON period*.

NOTE: When the indicated IAB-MT transmission timing mode is set to 'Case6' as specified in 3GPP TS 38.213 [10], the power imbalance for simultaneous transmission between IAB-DU and IAB-MT under which the system can be operated is declared by manufacturer.

### 6.6.3.2 Limits and *Basic limits*

The ACLR is defined with a square filter of bandwidth equal to the transmission bandwidth configuration of the transmitted signal ( $BW_{\text{Config}}$ ) centred on the assigned channel frequency and a filter centred on the adjacent channel frequency according to the tables below.

The ACLR shall be higher than the value specified in table 6.6.3.2-1.

Table 6.6.3.2-1: IAB-DU type 1-H and IAB-MT type 1-H ACLR limit

IAB-DU and IAB-MT channel bandwidth of lowest/highest carrier transmitted $BW_{\text{Channel}}$ (MHz)	IAB-DU and IAB-MT adjacent channel centre frequency offset below the lowest or above the highest carrier centre frequency transmitted	Assumed adjacent channel carrier (informative)	Filter on the adjacent channel frequency and corresponding filter bandwidth	ACLR limit
10, 15, 20, 25, 30, 35, 40, 45, 50, 60, 70, 80, 90, 100	$BW_{\text{Channel}}$	NR of same BW (Note 2)	Square ( $BW_{\text{Config}}$ )	45 dB
	$2 \times BW_{\text{Channel}}$	NR of same BW (Note 2)	Square ( $BW_{\text{Config}}$ )	45 dB
	$BW_{\text{Channel}}/2 + 2.5 \text{ MHz}$	5 MHz E-UTRA	Square (4.5 MHz)	45 dB (Note 3)
	$BW_{\text{Channel}}/2 + 7.5 \text{ MHz}$	5 MHz E-UTRA	Square (4.5 MHz)	45 dB (Note 3)
NOTE 1: $BW_{\text{Channel}}$ and $BW_{\text{Config}}$ are the IAB-DU and IAB-MT channel bandwidth and transmission bandwidth configuration of the lowest/highest carrier transmitted on the assigned channel frequency.				
NOTE 2: With SCS that provides largest transmission bandwidth configuration ( $BW_{\text{Config}}$ ).				
NOTE 3: The requirements are applicable when the band is also defined for E-UTRA or UTRA.				

The ACLR absolute *basic limit* is specified in table 6.6.3.2-2.

Table 6.6.3.2-2: IAB-DU type 1-H and IAB-MT type 1-H ACLR absolute basic limit

IAB-DU and IAB-MT category / class	ACLR absolute <i>basic limit</i>
Category A Wide Area IAB-DU and Category A Wide Area IAB-MT	-13 dBm/MHz
Category B Wide Area IAB-DU and Category B Wide Area IAB-MT	-15 dBm/MHz
Medium Range IAB-DU	-25 dBm/MHz
Local Area IAB-DU and Local Area IAB-MT	-32 dBm/MHz

For operation in non-contiguous spectrum or multiple bands, the ACLR shall be higher than the value specified in Table 6.6.3.2-3.

**Table 6.6.3.2-3: IAB-DU type 1-H and IAB-MT type 1-H ACLR limit in non-contiguous spectrum or multiple bands**

IAB-DU and IAB-MT channel bandwidth of lowest/highest carrier transmitted $BW_{\text{Channel}}$ (MHz)	Sub-block or Inter RF Bandwidth gap size ( $W_{\text{gap}}$ ) where the limit applies (MHz)	IAB-DU and IAB-MT adjacent channel centre frequency offset below or above the sub-block or IAB-DU or IAB-MT RF Bandwidth edge (inside the gap)	Assumed adjacent channel carrier	Filter on the adjacent channel frequency and corresponding filter bandwidth	ACLR limit
10, 15, 20	$W_{\text{gap}} \geq 15$ (Note 3) $W_{\text{gap}} \geq 45$ (Note 4)	2.5 MHz	5 MHz NR (Note 2)	Square ( $BW_{\text{Config}}$ )	45 dB
	$W_{\text{gap}} \geq 20$ (Note 3) $W_{\text{gap}} \geq 50$ (Note 4)	7.5 MHz	5 MHz NR (Note 2)	Square ( $BW_{\text{Config}}$ )	45 dB
25, 30, 35, 40, 45, 50, 60, 70, 80, 90, 100	$W_{\text{gap}} \geq 60$ (Note 4) $W_{\text{gap}} \geq 30$ (Note 3)	10 MHz	20 MHz NR (Note 2)	Square ( $BW_{\text{Config}}$ )	45 dB
	$W_{\text{gap}} \geq 80$ (Note 4) $W_{\text{gap}} \geq 50$ (Note 3)	30 MHz	20 MHz NR (Note 2)	Square ( $BW_{\text{Config}}$ )	45 dB
<p>NOTE 1: <math>BW_{\text{Config}}</math> is the transmission bandwidth configuration of the assumed adjacent channel carrier.</p> <p>NOTE 2: With SCS that provides largest transmission bandwidth configuration (<math>BW_{\text{Config}}</math>).</p> <p>NOTE 3: Applicable in case the <i>IAB-DU</i> or <i>IAB-MT channel bandwidth</i> of the NR carrier transmitted at the other edge of the gap is 10, 15, 20 MHz.</p> <p>NOTE 4: Applicable in case the <i>IAB-DU</i> or <i>IAB-MT channel bandwidth</i> of the NR carrier transmitted at the other edge of the gap is 25, 30, 35, 40, 45, 50, 60, 70, 80, 90, 100 MHz.</p>					

The Cumulative Adjacent Channel Leakage power Ratio (CACLR) in a *sub-block gap* or the *Inter RF Bandwidth gap* is the ratio of:

- the sum of the filtered mean power centred on the assigned channel frequencies for the two carriers adjacent to each side of the *sub-block gap* or the *Inter RF Bandwidth gap*, and
- the filtered mean power centred on a frequency channel adjacent to one of the respective *sub-block edges*, *IAB-MT RF Bandwidth edges* or *IAB-DU RF Bandwidth edges*.

The assumed filter for the adjacent channel frequency is defined in table 6.6.3.2-4 and the filters on the assigned channels are defined in table 6.6.3.2-6.

For operation in *non-contiguous spectrum* or multiple bands, the CACLR for NR carriers located on either side of the *sub-block gap* or the *Inter RF Bandwidth gap* shall be higher than the value specified in table 6.6.3.2-4.



**Table 6.6.3.2-4: IAB-DU type 1-H and IAB-MT type 1-H CACLR limit**

IAB-DU and IAB-MT channel bandwidth of lowest/highest carrier transmitted $BW_{Channel}$ (MHz)	Sub-block or Inter RF Bandwidth gap size ( $W_{gap}$ ) where the limit applies (MHz)	IAB-DU and IAB-MT adjacent channel centre frequency offset below or above the sub-block or IAB-DU or IAB-MT RF Bandwidth edge (inside the gap)	Assumed adjacent channel carrier	Filter on the adjacent channel frequency and corresponding filter bandwidth	CACLR limit
10, 15, 20	$5 \leq W_{gap} < 15$ (Note 3) $5 \leq W_{gap} < 45$ (Note 4)	2.5 MHz	5 MHz NR (Note 2)	Square ( $BW_{Config}$ )	45 dB
	$10 < W_{gap} < 20$ (Note 3) $10 \leq W_{gap} < 50$ (Note 4)	7.5 MHz	5 MHz NR (Note 2)	Square ( $BW_{Config}$ )	45 dB
25, 30, 35, 40, 45, 50, 60, 70, 80,90, 100	$20 \leq W_{gap} < 60$ (Note 4) $20 \leq W_{gap} < 30$ (Note 3)	10 MHz	20 MHz NR (Note 2)	Square ( $BW_{Config}$ )	45 dB
	$40 < W_{gap} < 80$ (Note 4) $40 \leq W_{gap} < 50$ (Note 3)	30 MHz	20 MHz NR (Note 2)	Square ( $BW_{Config}$ )	45 dB

NOTE 1:  $BW_{Config}$  is the transmission bandwidth configuration of the assumed adjacent channel carrier.  
 NOTE 2: With SCS that provides largest transmission bandwidth configuration ( $BW_{Config}$ ).  
 NOTE 3: Applicable in case the IAB-DU or IAB-MT channel bandwidth of the NR carrier transmitted at the other edge of the gap is 10, 15, 20 MHz.  
 NOTE 4: Applicable in case the IAB-DU or IAB-MT channel bandwidth of the NR carrier transmitted at the other edge of the gap is 25, 30, 35, 40, 45, 50, 60, 70, 80, 90, 100 MHz.

The CACLR absolute *basic limit* is specified in table 6.6.3.2-5.

**Table 6.6.3.2-5: IAB-DU type 1-H and IAB-MT type 1-H CACLR absolute basic limit**

IAB-DU and IAB-MT category / class	CACLR absolute <i>basic limit</i>
Category A Wide Area IAB-DU and Category A Wide Area IAB-MT	-13 dBm/MHz
Category B Wide Area IAB-DU and Category B Wide Area IAB-MT	-15 dBm/MHz
Medium Range IAB-DU	-25 dBm/MHz
Local Area IAB-DU and Local Area IAB-MT	-32 dBm/MHz

**Table 6.6.3.2-6: Filter parameters for the assigned channel**

RAT of the carrier adjacent to the <i>sub-block</i> or <i>Inter RF Bandwidth gap</i>	Filter on the assigned channel frequency and corresponding filter bandwidth
NR	NR of same BW with SCS that provides largest <i>transmission bandwidth configuration</i>

### 6.6.3.3 Minimum requirement for IAB-DU type 1-H and IAB-MT type 1-H

The ACLR (CACLR) absolute *basic limits* in table 6.6.3.2-2 + X, 6.6.3.2-5 + X (where  $X = 10\log_{10}(N_{TXU, countedpercell})$ ) or the ACLR (CACLR) *limits* in table 6.6.3.2-1, 6.6.3.2-3 or 6.6.3.2-4, whichever is less stringent, shall apply for each TAB connector TX min cell group.

NOTE: Conformance to the *IAB-DU type 1-H* and *IAB-MT type 1-H* ACLR requirements can be demonstrated by meeting at least one of the following criteria as determined by the manufacturer:

- 1) The ratio of the sum of the filtered mean power measured on each *TAB connector* in the *TAB connector TX min cell group* at the assigned channel frequency to the sum of the filtered mean power measured on each *TAB connector* in the *TAB connector TX min cell group* at the adjacent channel frequency shall be greater than or equal to the *ACLR basic limit*. This shall apply for each *TAB connector TX min cell group*.

Or

- 2) The ratio of the filtered mean power at the *TAB connector* centred on the assigned channel frequency to the filtered mean power at this *TAB connector* centred on the adjacent channel frequency shall be greater than or equal to the *ACLR basic limit* for every *TAB connector* in the *TAB connector TX min cell group*, for each *TAB connector TX min cell group*.

In case the ACLR (CACLR) absolute *basic limit* of *IAB-DU type 1-H* or *IAB-MT type 1-H* is applied, the conformance can be demonstrated by meeting at least one of the following criteria as determined by the manufacturer:

- 1) The sum of the filtered mean power measured on each *TAB connector* in the *TAB connector TX min cell group* at the adjacent channel frequency shall be less than or equal to the ACLR (CACLR) absolute *basic limit* + X. This shall apply to each *TAB connector TX min cell group*.

Or

- 2) The filtered mean power at each *TAB connector* centred on the adjacent channel frequency shall be less than or equal to the ACLR (CACLR) absolute *basic limit* scaled by  $X - 10\log_{10}(n)$  for every *TAB connector* in the *TAB connector TX min cell group*, for each *TAB connector TX min cell group*, where  $n$  is the number of *TAB connectors* in the *TAB connector TX min cell group*.

## 6.6.4 Operating band unwanted emissions

### 6.6.4.1 General

Unless otherwise stated, the operating band unwanted emission (OBUE) limits for IAB-DU in FR1 are defined from  $\Delta f_{\text{OBUE}}$  below the lowest frequency of each supported downlink *operating band* up to  $\Delta f_{\text{OBUE}}$  above the highest frequency of each supported downlink *operating band*. The values of  $\Delta f_{\text{OBUE}}$  are defined in table 6.6.1-1 for the NR *operating bands*.

Unless otherwise stated, the operating band unwanted emission (OBUE) limits for IAB-MT in FR1 are defined from  $\Delta f_{\text{OBUE}}$  below the lowest frequency of each supported uplink *operating band* up to  $\Delta f_{\text{OBUE}}$  above the highest frequency of each supported uplink *operating band*. The values of  $\Delta f_{\text{OBUE}}$  are defined in table 6.6.1-2 for the NR *operating bands*.

The requirements shall apply whatever the type of transmitter considered and for all transmission modes foreseen by the manufacturer's specification. In addition, for IAB-DU and IAB-MT operating in *non-contiguous spectrum*, the requirements apply inside any *sub-block gap*. In addition, for a IAB-MT or IAB-DU operating in multiple bands, the requirements apply inside any *Inter RF Bandwidth gap*.

*Basic limits* are specified in the tables below, where:

- $\Delta f$  is the separation between the *channel edge* frequency and the nominal -3dB point of the measuring filter closest to the carrier frequency.
- $f_{\text{offset}}$  is the separation between the *channel edge* frequency and the centre of the measuring filter.
- $f_{\text{offset,max}}$  is the offset to the frequency  $\Delta f_{\text{OBUE}}$  outside the downlink *operating band* of IAB-DU and uplink *operating band* of IAB-MT, where  $\Delta f_{\text{OBUE}}$  is defined in tables 6.6.1-1 and 6.6.1-2.
- $\Delta f_{\text{max}}$  is equal to  $f_{\text{offset,max}}$  minus half of the bandwidth of the measuring filter.

For a *multi-band connector* inside any *Inter RF Bandwidth gaps* with  $W_{\text{gap}} < 2 * \Delta f_{\text{OBUE}}$ , a combined *basic limit* shall be applied which is the cumulative sum of the *basic limits* specified at the *IAB-DU* and *IAB-MT RF Bandwidth edges* on

each side of the *Inter RF Bandwidth gap*. The *basic limit* for *IAB-DU* and *IAB-MT RF Bandwidth edge* is specified in clauses 6.6.4.2.1 to 6.6.4.2.4 below, where in this case:

- $\Delta f$  is the separation between the *IAB-DU* or *IAB-MT RF Bandwidth edge* frequency and the nominal -3 dB point of the measuring filter closest to the *IAB-DU* or *IAB-MT RF Bandwidth edge*.
- $f_{\text{offset}}$  is the separation from the *IAB-DU* or *IAB-MT RF Bandwidth edge* frequency to the centre of the measuring filter.
- $f_{\text{offset}_{\text{max}}}$  is equal to the *Inter RF Bandwidth gap* minus half of the bandwidth of the measuring filter.
- $\Delta f_{\text{max}}$  is equal to  $f_{\text{offset}_{\text{max}}}$  minus half of the bandwidth of the measuring filter.

For a *multi-band connector* of *IAB-DU*, the operating band unwanted emission limits apply also in a supported downlink *operating band* without any carrier transmitted, in the case where there are carrier(s) transmitted in another supported downlink *operating band*. In this case, no cumulative *basic limit* is applied in the *inter-band gap* between a supported downlink *operating band* with carrier(s) transmitted and a supported downlink *operating band* without any carrier transmitted and

- In case the *inter-band gap* between a supported downlink *operating band* with carrier(s) transmitted and a supported downlink *operating band* without any carrier transmitted is less than  $2 * \Delta f_{\text{OBUE}}$ ,  $f_{\text{offset}_{\text{max}}}$  shall be the offset to the frequency  $\Delta f_{\text{OBUE}}$  MHz outside the outermost edges of the two supported downlink *operating bands* and the operating band unwanted emission *basic limits* of the band where there are carriers transmitted, as defined in the tables of the present clause, shall apply across both downlink bands.
- In other cases, the operating band unwanted emission *basic limits* of the band where there are carriers transmitted, as defined in the tables of the present clause for the largest frequency offset ( $\Delta f_{\text{max}}$ ), shall apply from  $\Delta f_{\text{OBUE}}$  MHz below the lowest frequency, up to  $\Delta f_{\text{OBUE}}$  MHz above the highest frequency of the supported downlink *operating band* without any carrier transmitted.

For a *multi-band connector* of *IAB-MT*, the operating band unwanted emission limits apply also in a supported uplink *operating band* without any carrier transmitted, in the case where there are carrier(s) transmitted in another supported uplink *operating band*. In this case, no cumulative *basic limit* is applied in the *inter-band gap* between a supported uplink *operating band* with carrier(s) transmitted and a supported uplink *operating band* without any carrier transmitted and

- In case the *inter-band gap* between a supported uplink *operating band* with carrier(s) transmitted and a supported uplink *operating band* without any carrier transmitted is less than  $2 * \Delta f_{\text{OBUE}}$ ,  $f_{\text{offset}_{\text{max}}}$  shall be the offset to the frequency  $\Delta f_{\text{OBUE}}$  MHz outside the outermost edges of the two supported uplink *operating bands* and the operating band unwanted emission *basic limits* of the band where there are carriers transmitted, as defined in the tables of the present clause, shall apply across both uplink bands.
- In other cases, the operating band unwanted emission *basic limits* of the band where there are carriers transmitted, as defined in the tables of the present clause for the largest frequency offset ( $\Delta f_{\text{max}}$ ), shall apply from  $\Delta f_{\text{OBUE}}$  MHz below the lowest frequency, up to  $\Delta f_{\text{OBUE}}$  MHz above the highest frequency of the supported uplink *operating band* without any carrier transmitted.

For a multicarrier *single-band connector* or a *single-band connector* configured for intra-band contiguous or non-contiguous *carrier aggregation* the definitions above apply to the lower edge of the carrier transmitted at the *lowest carrier* frequency and the upper edge of the carrier transmitted at the *highest carrier* frequency within a specified frequency band.

In addition, inside any *sub-block gap* for a *single-band connector* operating in *non-contiguous spectrum*, a combined *basic limit* shall be applied which is the cumulative sum of the *basic limits* specified for the adjacent *sub-blocks* on each side of the *sub-block gap*. The *basic limit* for each *sub-block* is specified in clauses 6.6.4.2.1 to 6.6.4.2.4 below, where in this case:

- $\Delta f$  is the separation between the *sub-block* edge frequency and the nominal -3 dB point of the measuring filter closest to the *sub-block* edge.
- $f_{\text{offset}}$  is the separation between the *sub-block* edge frequency and the centre of the measuring filter.
- $f_{\text{offset}_{\text{max}}}$  is equal to the *sub-block gap* bandwidth minus half of the bandwidth of the measuring filter.
- $\Delta f_{\text{max}}$  is equal to  $f_{\text{offset}_{\text{max}}}$  minus half of the bandwidth of the measuring filter.

For Wide Area IAB-DU and Wide Area IAB-MT, the requirements of either clause 6.6.4.2.1 (Category A limits) or clause 6.6.4.2.2 (Category B limits) shall apply.

For Medium Range IAB-DU, the requirements in clause 6.6.4.2.3 shall apply (Category A and B).

For Local Area IAB-DU and Local Area IAB-MT, the requirements of clause 6.6.4.2.4 shall apply (Category A and B).

The application of either Category A or Category B *basic limits* shall be the same as for Transmitter spurious emissions in clause 6.6.5.

## 6.6.4.2 Basic limits

### 6.6.4.2.1 Basic limits for Wide Area IAB-DU and Wide Area IAB-MT (Category A)

For operating in Bands n41, n77, n78, n79, *basic limits* are specified in table 6.6.4.2.1-1:

**Table 6.6.4.2.1-1: Wide Area IAB-DU and Wide Area IAB-MT *operating band* unwanted emission limits (NR bands above 1 GHz) for Category A**

Frequency offset of measurement filter -3dB point, $\Delta f$	Frequency offset of measurement filter centre frequency, $f_{\text{offset}}$	<i>Basic limits</i> (Note 1, 2)	<i>Measurement bandwidth</i>
$0 \text{ MHz} \leq \Delta f < 5 \text{ MHz}$	$0.05 \text{ MHz} \leq f_{\text{offset}} < 5.05 \text{ MHz}$	$-7 \text{ dBm} - \frac{7}{5} \cdot \left( \frac{f_{\text{offset}}}{\text{MHz}} - 0.05 \right) \text{ dB}$	100 kHz
$5 \text{ MHz} \leq \Delta f < \min(10 \text{ MHz}, \Delta f_{\text{max}})$	$5.05 \text{ MHz} \leq f_{\text{offset}} < \min(10.05 \text{ MHz}, f_{\text{offset}_{\text{max}}})$	-14 dBm	100 kHz
$10 \text{ MHz} \leq \Delta f \leq \Delta f_{\text{max}}$	$10.5 \text{ MHz} \leq f_{\text{offset}} < f_{\text{offset}_{\text{max}}}$	-13 dBm (Note 3)	1MHz
<p>NOTE 1: For an IAB-DU and IAB-MT supporting <i>non-contiguous spectrum</i> operation within any <i>operating band</i>, the emission limits within <i>sub-block gaps</i> is calculated as a cumulative sum of contributions from adjacent <i>sub-blocks</i> on each side of the <i>sub-block gap</i>, where the contribution from the far-end <i>sub-block</i> shall be scaled according to the <i>measurement bandwidth</i> of the near-end <i>sub-block</i>. Exception is <math>\Delta f \geq 10 \text{ MHz}</math> from both adjacent <i>sub-blocks</i> on each side of the <i>sub-block gap</i>, where the emission limits within <i>sub-block gaps</i> shall be -13 dBm/1 MHz.</p> <p>NOTE 2: For a <i>multi-band connector</i> with <i>Inter RF Bandwidth gap</i> <math>&lt; 2 \cdot \Delta f_{\text{OBUE}}</math> the emission limits within the <i>Inter RF Bandwidth gaps</i> is calculated as a cumulative sum of contributions from adjacent <i>sub-blocks</i> or RF Bandwidth on each side of the <i>Inter RF Bandwidth gap</i>, where the contribution from the far-end <i>sub-block</i> or RF Bandwidth shall be scaled according to the <i>measurement bandwidth</i> of the near-end <i>sub-block</i> or RF Bandwidth.</p> <p>NOTE 3: The requirement is not applicable when <math>\Delta f_{\text{max}} &lt; 10 \text{ MHz}</math>.</p>			

### 6.6.4.2.2 Basic limits for Wide Area IAB-DU and Wide Area IAB-MT (Category B)

For Category B Operating band unwanted emissions, the *basic limits* in clause 6.6.4.2.2.1 shall be applied.

#### 6.6.4.2.2.1 Category B requirements

For IAB-DU and IAB-MT operating in Bands n41, n77, n78, n79 *basic limits* are specified in tables 6.6.4.2.2.1-1:

**Table 6.6.4.2.2.1-1: Wide Area IAB-DU and IAB-MT operating band unwanted emission limits for Category B**

Frequency offset of measurement filter -3dB point, $\Delta f$	Frequency offset of measurement filter centre frequency, $f_{\text{offset}}$	Basic limits (Note 1, 2)	Measurement bandwidth
$0 \text{ MHz} \leq \Delta f < 5 \text{ MHz}$	$0.05 \text{ MHz} \leq f_{\text{offset}} < 5.05 \text{ MHz}$	$-7 \text{ dBm} - \frac{7}{5} \cdot \left( \frac{f_{\text{offset}}}{\text{MHz}} - 0.05 \right) \text{ dB}$	100 kHz
$5 \text{ MHz} \leq \Delta f < \min(10 \text{ MHz}, \Delta f_{\text{max}})$	$5.05 \text{ MHz} \leq f_{\text{offset}} < \min(10.05 \text{ MHz}, f_{\text{offset}_{\text{max}}})$	-14 dBm	100 kHz
$10 \text{ MHz} \leq \Delta f \leq \Delta f_{\text{max}}$	$10.5 \text{ MHz} \leq f_{\text{offset}} < f_{\text{offset}_{\text{max}}}$	-15 dBm (Note 3)	1MHz
<p>NOTE 1: For an IAB-DU and IAB-MT supporting <i>non-contiguous spectrum</i> operation within any <i>operating band</i>, the emission limits within <i>sub-block gaps</i> is calculated as a cumulative sum of contributions from adjacent <i>sub-blocks</i> on each side of the <i>sub-block gap</i>, where the contribution from the far-end <i>sub-block</i> shall be scaled according to the <i>measurement bandwidth</i> of the near-end <i>sub-block</i>. Exception is <math>\Delta f \geq 10 \text{ MHz}</math> from both adjacent <i>sub-blocks</i> on each side of the <i>sub-block gap</i>, where the emission limits within <i>sub-block gaps</i> shall be -15 dBm/1 MHz.</p> <p>NOTE 2: For a <i>multi-band connector</i> with <i>Inter RF Bandwidth gap</i> <math>&lt; 2 \cdot \Delta f_{\text{OBUe}}</math> the emission limits within the <i>Inter RF Bandwidth gaps</i> is calculated as a cumulative sum of contributions from adjacent <i>sub-blocks</i> or RF Bandwidth on each side of the <i>Inter RF Bandwidth gap</i>, where the contribution from the far-end <i>sub-block</i> or RF Bandwidth shall be scaled according to the <i>measurement bandwidth</i> of the near-end <i>sub-block</i> or RF Bandwidth.</p> <p>NOTE 3: The requirement is not applicable when <math>\Delta f_{\text{max}} &lt; 10 \text{ MHz}</math>.</p>			

#### 6.6.4.2.3 Basic limits for Medium Range IAB-DU (Category A and B)

For Medium Range IAB-DU, *basic limits* are specified in table 6.6.4.2.3-1 and table 6.6.4.2.3-2.

For the tables in this clause for *IAB-DU type I-H*  $P_{\text{rated},x} = P_{\text{rated},c,\text{cell}} - 10 \cdot \log_{10}(N_{\text{TXU,countedpercell}})$ , and *IAB-DU type I-O*  $P_{\text{rated},x} = P_{\text{rated},c,\text{TRP}} - 9 \text{ dB}$ .

**Table 6.6.4.2.3-1: Medium Range IAB-DU operating band unwanted emission limits,  $31 < P_{\text{rated},x} \leq 38 \text{ dBm}$** 

Frequency offset of measurement filter -3dB point, $\Delta f$	Frequency offset of measurement filter centre frequency, $f_{\text{offset}}$	Basic limits (Note 1, 2)	Measurement bandwidth
$0 \text{ MHz} \leq \Delta f < 5 \text{ MHz}$	$0.05 \text{ MHz} \leq f_{\text{offset}} < 5.05 \text{ MHz}$	$P_{\text{rated},x} - 53 \text{ dB} - \frac{7}{5} \cdot \left( \frac{f_{\text{offset}}}{\text{MHz}} - 0.05 \right) \text{ dB}$	100 kHz
$5 \text{ MHz} \leq \Delta f < \min(10 \text{ MHz}, \Delta f_{\text{max}})$	$5.05 \text{ MHz} \leq f_{\text{offset}} < \min(10.05 \text{ MHz}, f_{\text{offset}_{\text{max}}})$	$P_{\text{rated},x} - 60 \text{ dB}$	100 kHz
$10 \text{ MHz} \leq \Delta f \leq \Delta f_{\text{max}}$	$10.05 \text{ MHz} \leq f_{\text{offset}} < f_{\text{offset}_{\text{max}}}$	$\text{Min}(P_{\text{rated},x} - 60 \text{ dB}, -25 \text{ dBm})$ (Note 3)	100 kHz
<p>NOTE 1: For an IAB-DU supporting <i>non-contiguous spectrum</i> operation within any <i>operating band</i> the emission limits within <i>sub-block gaps</i> is calculated as a cumulative sum of contributions from adjacent <i>sub-blocks</i> on each side of the <i>sub-block gap</i>. Exception is <math>\Delta f \geq 10 \text{ MHz}</math> from both adjacent <i>sub-blocks</i> on each side of the <i>sub-block gap</i>, where the emission limits within <i>sub-block gaps</i> shall be <math>\text{Min}(P_{\text{rated},x} - 60 \text{ dB}, -25 \text{ dBm})/100 \text{ kHz}</math>.</p> <p>NOTE 2: For a <i>multi-band connector</i> with <i>Inter RF Bandwidth gap</i> <math>&lt; 2 \cdot \Delta f_{\text{OBUe}}</math> the emission limits within the <i>Inter RF Bandwidth gaps</i> is calculated as a cumulative sum of contributions from adjacent <i>sub-blocks</i> or RF Bandwidth on each side of the <i>Inter RF Bandwidth gap</i>.</p> <p>NOTE 3: The requirement is not applicable when <math>\Delta f_{\text{max}} &lt; 10 \text{ MHz}</math>.</p>			

Table 6.6.4.2.3-2: Medium Range IAB-DU operating band unwanted emission limits,  $P_{\text{rated},x} \leq 31$  dBm

Frequency offset of measurement filter -3dB point, $\Delta f$	Frequency offset of measurement filter centre frequency, $f_{\text{offset}}$	Basic limits (Note 1, 2)	Measurement bandwidth
$0 \text{ MHz} \leq \Delta f < 5 \text{ MHz}$	$0.05 \text{ MHz} \leq f_{\text{offset}} < 5.05 \text{ MHz}$	$-22\text{dBm} - \frac{7}{5} \left( \frac{f_{\text{offset}}}{\text{MHz}} - 0.05 \right) \text{dB}$	100 kHz
$5 \text{ MHz} \leq \Delta f < \min(10 \text{ MHz}, \Delta f_{\text{max}})$	$5.05 \text{ MHz} \leq f_{\text{offset}} < \min(10.05 \text{ MHz}, f_{\text{offset}_{\text{max}}})$	-29 dBm	100 kHz
$10 \text{ MHz} \leq \Delta f \leq \Delta f_{\text{max}}$	$10.05 \text{ MHz} \leq f_{\text{offset}} < f_{\text{offset}_{\text{max}}}$	-29 dBm (Note 3)	100 kHz

NOTE 1: For an IAB-DU supporting *non-contiguous spectrum* operation within any *operating band* the emission limits within *sub-block gaps* is calculated as a cumulative sum of contributions from adjacent *sub-blocks* on each side of the *sub-block gap*. Exception is  $\Delta f \geq 10\text{MHz}$  from both adjacent *sub-blocks* on each side of the *sub-block gap*, where the emission limits within *sub-block gaps* shall be -29dBm/100kHz.

NOTE 2: For a *multi-band connector* with *Inter RF Bandwidth gap*  $< 2 \cdot \Delta f_{\text{OBUE}}$  the emission limits within the *Inter RF Bandwidth gaps* is calculated as a cumulative sum of contributions from adjacent *sub-blocks* or RF Bandwidth on each side of the *Inter RF Bandwidth gap*.

NOTE 3: The requirement is not applicable when  $\Delta f_{\text{max}} < 10$  MHz.

#### 6.6.4.2.4 Basic limits for Local Area IAB-DU and Local Area IAB-MT (Category A and B)

For Local Area IAB-DU and Local Area IAB-MT, *basic limits* are specified in table 6.6.4.2.4-1.

Table 6.6.4.2.4-1: Local Area IAB-DU and Local Area IAB-MT operating band unwanted emission limits

Frequency offset of measurement filter -3dB point, $\Delta f$	Frequency offset of measurement filter centre frequency, $f_{\text{offset}}$	Basic limits (Note 1, 2)	Measurement bandwidth
$0 \text{ MHz} \leq \Delta f < 5 \text{ MHz}$	$0.05 \text{ MHz} \leq f_{\text{offset}} < 5.05 \text{ MHz}$	$-30\text{dBm} - \frac{7}{5} \left( \frac{f_{\text{offset}}}{\text{MHz}} - 0.05 \right) \text{dB}$	100 kHz
$5 \text{ MHz} \leq \Delta f < \min(10 \text{ MHz}, \Delta f_{\text{max}})$	$5.05 \text{ MHz} \leq f_{\text{offset}} < \min(10.05 \text{ MHz}, f_{\text{offset}_{\text{max}}})$	-37 dBm	100 kHz
$10 \text{ MHz} \leq \Delta f \leq \Delta f_{\text{max}}$	$10.05 \text{ MHz} \leq f_{\text{offset}} < f_{\text{offset}_{\text{max}}}$	-37 dBm (Note 10)	100 kHz

NOTE 1: For an IAB-DU and IAB-MT supporting *non-contiguous spectrum* operation within any *operating band* the emission limits within *sub-block gaps* is calculated as a cumulative sum of contributions from adjacent *sub-blocks* on each side of the *sub-block gap*. Exception is  $\Delta f \geq 10\text{MHz}$  from both adjacent *sub-blocks* on each side of the *sub-block gap*, where the emission limits within *sub-block gaps* shall be -37dBm/100kHz.

NOTE 2: For a *multi-band connector* with *Inter RF Bandwidth gap*  $< 2 \cdot \Delta f_{\text{OBUE}}$  the emission limits within the *Inter RF Bandwidth gaps* is calculated as a cumulative sum of contributions from adjacent *sub-blocks* or RF Bandwidth on each side of the *Inter RF Bandwidth gap*.

NOTE 3: The requirement is not applicable when  $\Delta f_{\text{max}} < 10$  MHz.

#### 6.6.4.2.5 Basic limits for additional requirements

##### 6.6.4.2.5.1 Limits in FCC Title 47

In addition to the requirements in clauses 6.6.4.2.1, 6.6.4.2.2, 6.6.4.2.3 and 6.6.4.2.4, the IAB-DU and IAB-MT may have to comply with the applicable emission limits established by FCC Title 47 [20], when deployed in regions where those limits are applied, and under the conditions declared by the manufacturer.

#### 6.6.4.3 Minimum requirements for IAB-DU type 1-H and IAB-MT type 1-H

The operating band unwanted emissions requirements for *IAB-DU type 1-H* and *IAB-MT type 1-H* are that for each *TAB connector TX min cell group* and each applicable *basic limit* in clause 6.6.4.2, the power summation emissions at the *TAB connectors* of the *TAB connector TX min cell group* shall not exceed a limit specified as the *basic limit* + X, where  $X = 10 \log_{10}(N_{\text{TXU, counted per cell}})$ .

NOTE: Conformance to the *IAB-DU type 1-H* and *IAB-MT type 1-H* operating band unwanted emission requirement can be demonstrated by meeting at least one of the following criteria as determined by the manufacturer:

1) The sum of the emissions power measured on each *TAB connector* in the *TAB connector TX min cell group* shall be less than or equal to the limit as defined in this clause for the respective frequency span.

Or

2) The unwanted emissions power at each *TAB connector* shall be less than or equal to the *type 1-H* limit as defined in this clause for the respective frequency span, scaled by  $-10\log_{10}(n)$ , where  $n$  is the number of *TAB connectors* in the *TAB connector TX min cell group*.

## 6.6.5 Transmitter spurious emissions

### 6.6.5.1 General

For IAB-DU, the transmitter spurious emission limits shall apply from 9 kHz to 12.75 GHz, excluding the frequency range from  $\Delta f_{\text{OBUE}}$  below the lowest frequency of each supported downlink *operating band*, up to  $\Delta f_{\text{OBUE}}$  above the highest frequency of each supported downlink *operating band*, where the  $\Delta f_{\text{OBUE}}$  is defined in table 6.6.1-1. For some *operating bands*, the upper limit is higher than 12.75 GHz in order to comply with the 5<sup>th</sup> harmonic limit of the downlink *operating band*, as specified in ITU-R recommendation SM.329 [16].

For IAB-MT, the transmitter spurious emission limits shall apply from 9 kHz to 12.75 GHz, excluding the frequency range from  $\Delta f_{\text{OBUE}}$  below the lowest frequency of each supported uplink *operating band*, up to  $\Delta f_{\text{OBUE}}$  above the highest frequency of each supported uplink *operating band*, where the  $\Delta f_{\text{OBUE}}$  is defined in table 6.6.1-2. For some *operating bands*, the upper limit is higher than 12.75 GHz in order to comply with the 5<sup>th</sup> harmonic limit of the uplink *operating band*, as specified in ITU-R recommendation SM.329 [16].

For a *multi-band connector*, for each supported *operating band* together with  $\Delta f_{\text{OBUE}}$  around the band is excluded from the transmitter spurious emissions requirement.

The requirements shall apply whatever the type of transmitter considered (single carrier or multi-carrier). It applies for all transmission modes foreseen by the manufacturer's specification.

Unless otherwise stated, all requirements are measured as mean power (RMS).

## 6.6.5.2 Basic limits

### 6.6.5.2.1 General transmitter spurious emissions requirements

The *basic limits* of either table 6.6.5.2.1-1 (Category A limits) or table 6.6.5.2.1-2 (Category B limits) shall apply. The application of either Category A or Category B limits shall be the same as for operating band unwanted emissions in clause 6.6.4.

**Table 6.6.5.2.1-1: General IAB-DU and IAB-MT transmitter spurious emission limits in FR1, Category A**

Spurious frequency range	Basic limit	Measurement bandwidth	Notes
9 kHz – 150 kHz	-13 dBm	1 kHz	Note 1, Note 4
150 kHz – 30 MHz		10 kHz	Note 1, Note 4
30 MHz – 1 GHz		100 kHz	Note 1
1 GHz – 12.75 GHz		1 MHz	Note 1, Note 2
12.75 GHz – 5 <sup>th</sup> harmonic of the upper frequency edge of the DL <i>operating band</i> in GHz		1 MHz	Note 1, Note 2, Note 3
NOTE 1: <i>Measurement bandwidths</i> as in ITU-R SM.329 [16], s4.1.			
NOTE 2: Upper frequency as in ITU-R SM.329 [16], s2.5 table 1.			
NOTE 3: For IAB-DU, this spurious frequency range applies only for <i>operating bands</i> for which the 5 <sup>th</sup> harmonic of the upper frequency edge of the DL <i>operating band</i> is reaching beyond 12.75 GHz. For IAB-MT, this spurious frequency range applies only for <i>operating bands</i> for which the 5 <sup>th</sup> harmonic of the upper frequency edge of the UL <i>operating band</i> is reaching beyond 12.75 GHz.			
NOTE 4: This spurious frequency range applies only to <i>IAB-DU type 1-H and IAB-MT type 1-H</i> .			

**Table 6.6.5.2.1-2: General IAB-DU and IAB-MT transmitter spurious emission limits in FR1, Category B**

Spurious frequency range	Basic limit	Measurement bandwidth	Notes
9 kHz – 150 kHz	-36 dBm	1 kHz	Note 1, Note 4
150 kHz – 30 MHz		10 kHz	Note 1, Note 4
30 MHz – 1 GHz		100 kHz	Note 1
1 GHz – 12.75 GHz	-30 dBm	1 MHz	Note 1, Note 2
12.75 GHz – 5 <sup>th</sup> harmonic of the upper frequency edge of the DL <i>operating band</i> in GHz		1 MHz	Note 1, Note 2, Note 3
NOTE 1: <i>Measurement bandwidths</i> as in ITU-R SM.329 [16], s4.1.			
NOTE 2: Upper frequency as in ITU-R SM.329 [16], s2.5 table 1.			
NOTE 3: For IAB-DU, this spurious frequency range applies only for <i>operating bands</i> for which the 5 <sup>th</sup> harmonic of the upper frequency edge of the DL <i>operating band</i> is reaching beyond 12.75 GHz. For IAB-MT, this spurious frequency range applies only for <i>operating bands</i> for which the 5 <sup>th</sup> harmonic of the upper frequency edge of the UL <i>operating band</i> is reaching beyond 12.75 GHz.			
NOTE 4: This spurious frequency range applies only to <i>IAB-DU type 1-H and IAB-MT type 1-H</i> .			

### 6.6.5.2.2 Additional spurious emissions requirements

These requirements may be applied for the protection of system operating in other frequency ranges. The limits may apply as an optional protection of such systems that are deployed in the same geographical area as the IAB-Node, or they may be set by local or regional regulation as a mandatory requirement for an NR *operating band*. It is in some cases not stated in the present document whether a requirement is mandatory or under what exact circumstances that a limit applies, since this is set by local or regional regulation. An overview of regional requirements in the present document is given in clause 4.5.



Some requirements may apply for the protection of specific equipment (UE, MS and/or BS) or equipment operating in specific systems (GSM, CDMA, UTRA, E-UTRA, NR, etc.) as listed below.

The spurious emission *basic limits* are provided in table 6.6.5.2.2-1 where requirements for co-existence with the system listed in the first column apply for IAB-MT and IAB-DU. For a *multi-band connector*, the exclusions and conditions in the Note column of table 6.6.5.2.2-1 apply for each supported *operating band*.

**Table 6.6.5.2.2-1: IAB-DU and IAB-MT spurious emissions *basic limits* for co-existence with systems operating in other frequency bands**

System type to co-exist with	Frequency range for co-existence requirement	Basic limits	Measurement bandwidth	Note
GSM900	921 – 960 MHz	-57 dBm	100 kHz	
	876 – 915 MHz	-61 dBm	100 kHz	
DCS1800	1805 – 1880 MHz	-47 dBm	100 kHz	
	1710 – 1785 MHz	-61 dBm	100 kHz	
PCS1900	1930 – 1990 MHz	-47 dBm	100 kHz	
	1850 – 1910 MHz	-61 dBm	100 kHz	
GSM850 or CDMA850	869 – 894 MHz	-57 dBm	100 kHz	
	824 – 849 MHz	-61 dBm	100 kHz	
UTRA FDD Band I or E-UTRA Band 1 or NR Band n1	2110 – 2170 MHz	-52 dBm	1 MHz	
	1920 – 1980 MHz	-49 dBm	1 MHz	
UTRA FDD Band II or E-UTRA Band 2 or NR Band n2	1930 – 1990 MHz	-52 dBm	1 MHz	
	1850 – 1910 MHz	-49 dBm	1 MHz	
UTRA FDD Band III or E-UTRA Band 3 or NR Band n3	1805 – 1880 MHz	-52 dBm	1 MHz	
	1710 – 1785 MHz	-49 dBm	1 MHz	
UTRA FDD Band IV or E-UTRA Band 4	2110 – 2155 MHz	-52 dBm	1 MHz	
	1710 – 1755 MHz	-49 dBm	1 MHz	
UTRA FDD Band V or E-UTRA Band 5 or NR Band n5	869 – 894 MHz	-52 dBm	1 MHz	
	824 – 849 MHz	-49 dBm	1 MHz	
UTRA FDD Band VI, XIX or E-UTRA Band 6, 18, 19 or NR Band n18	860 – 890 MHz	-52 dBm	1 MHz	
	815 – 830 MHz	-49 dBm	1 MHz	
	830 – 845 MHz	-49 dBm	1 MHz	
UTRA FDD Band VII or E-UTRA Band 7 or NR Band n7	2620 – 2690 MHz	-52 dBm	1 MHz	
	2500 – 2570 MHz	-49 dBm	1 MHz	
UTRA FDD Band VIII or E-UTRA Band 8 or NR Band n8	925 – 960 MHz	-52 dBm	1 MHz	
	880 – 915 MHz	-49 dBm	1 MHz	
UTRA FDD Band IX or E-UTRA Band 9	1844.9 – 1879.9 MHz	-52 dBm	1 MHz	
	1749.9 – 1784.9 MHz	-49 dBm	1 MHz	
UTRA FDD Band X or E-UTRA Band 10	2110 – 2170 MHz	-52 dBm	1 MHz	
	1710 – 1770 MHz	-49 dBm	1 MHz	

UTRA FDD Band XI or XXI or E-UTRA Band 11 or 21	1475.9 – 1510.9 MHz	-52 dBm	1 MHz	
	1427.9 – 1447.9 MHz	-49 dBm	1 MHz	
	1447.9 – 1462.9 MHz	-49 dBm	1 MHz	
UTRA FDD Band XII or E-UTRA Band 12 or NR Band n12	729 – 746 MHz	-52 dBm	1 MHz	
	699 – 716 MHz	-49 dBm	1 MHz	
UTRA FDD Band XIII or E-UTRA Band 13	746 – 756 MHz	-52 dBm	1 MHz	
	777 – 787 MHz	-49 dBm	1 MHz	
UTRA FDD Band XIV or E-UTRA Band 14 or NR band n14	758 – 768 MHz	-52 dBm	1 MHz	
	788 – 798 MHz	-49 dBm	1 MHz	
E-UTRA Band 17	734 – 746 MHz	-52 dBm	1 MHz	
	704 – 716 MHz	-49 dBm	1 MHz	
UTRA FDD Band XX or E- UTRA Band 20 or NR Band n20	791 – 821 MHz	-52 dBm	1 MHz	
	832 – 862 MHz	-49 dBm	1 MHz	
UTRA FDD Band XXII or E-UTRA Band 22	3510 – 3590 MHz	-52 dBm	1 MHz	This requirement does not apply to IAB-DU and IAB-MT operating in band n77 or n78.
	3410 – 3490 MHz	-49 dBm	1 MHz	This requirement does not apply to IAB-DU and IAB-MT operating in band n77 or n78.
E-UTRA Band 24	1525 – 1559 MHz	-52 dBm	1 MHz	
	1626.5 – 1660.5 MHz	-49 dBm	1 MHz	
UTRA FDD Band XXV or E-UTRA Band 25 or NR band n25	1930 – 1995 MHz	-52 dBm	1 MHz	
	1850 – 1915 MHz	-49 dBm	1 MHz	
UTRA FDD Band XXVI or E-UTRA Band 26 or NR Band n26	859 – 894 MHz	-52 dBm	1 MHz	
	814 – 849 MHz	-49 dBm	1 MHz	
E-UTRA Band 27	852 – 869 MHz	-52 dBm	1 MHz	
	807 – 824 MHz	-49 dBm	1 MHz	
E-UTRA Band 28 or NR Band n28	758 – 803 MHz	-52 dBm	1 MHz	
	703 – 748 MHz	-49 dBm	1 MHz	
E-UTRA Band 29 or NR Band n29	717 – 728 MHz	-52 dBm	1 MHz	

E-UTRA Band 30 or NR Band n30	2350 – 2360 MHz	-52 dBm	1 MHz	
	2305 – 2315 MHz	-49 dBm	1 MHz	
E-UTRA Band 31	462.5 – 467.5 MHz	-52 dBm	1 MHz	
	452.5 – 457.5 MHz	-49 dBm	1 MHz	
UTRA FDD band XXXII or E-UTRA band 32	1452 – 1496 MHz	-52 dBm	1 MHz	
UTRA TDD Band a) or E-UTRA Band 33	1900 – 1920 MHz	-52 dBm	1 MHz	
UTRA TDD Band a) or E-UTRA Band 34 or NR band n34	2010 – 2025 MHz	-52 dBm	1 MHz	
UTRA TDD Band b) or E-UTRA Band 35	1850 – 1910 MHz	-52 dBm	1 MHz	
UTRA TDD Band b) or E-UTRA Band 36	1930 – 1990 MHz	-52 dBm	1 MHz	
UTRA TDD Band c) or E-UTRA Band 37	1910 – 1930 MHz	-52 dBm	1 MHz	
UTRA TDD Band d) or E-UTRA Band 38 or NR Band n38	2570 – 2620 MHz	-52 dBm	1 MHz	
UTRA TDD Band f) or E-UTRA Band 39 or NR band n39	1880 – 1920MHz	-52 dBm	1 MHz	
UTRA TDD Band e) or E-UTRA Band 40 or NR Band n40	2300 – 2400MHz	-52 dBm	1 MHz	
E-UTRA Band 41 or NR Band n41, n90	2496 – 2690 MHz	-52 dBm	1 MHz	This is not applicable IAB-DU and IAB-MT operating in Band n41.
E-UTRA Band 42	3400 – 3600 MHz	-52 dBm	1 MHz	This is not applicable to IAB-DU and IAB-MT operating in Band n77 or n78.
E-UTRA Band 43	3600 – 3800 MHz	-52 dBm	1 MHz	This is not applicable to IAB-DU and IAB-MT operating in Band n77 or n78.
E-UTRA Band 44	703 – 803 MHz	-52 dBm	1 MHz	
E-UTRA Band 45	1447 – 1467 MHz	-52 dBm	1 MHz	
E-UTRA Band 46 or NR Band n46	5150 – 5925 MHz	-52 dBm	1 MHz	
E-UTRA Band 47	5855 – 5925 MHz	-52 dBm	1 MHz	
E-UTRA Band 48 or NR Band n48	3550 – 3700 MHz	-52 dBm	1 MHz	This is not applicable to IAB-DU and IAB-MT operating in Band n77 or n78.
E-UTRA Band 50 or NR band n50	1432 – 1517 MHz	-52 dBm	1 MHz	
E-UTRA Band 51 or NR Band n51	1427 – 1432 MHz	-52 dBm	1 MHz	

E-UTRA Band 53 or NR Band n53	2483.5 - 2495 MHz	-52 dBm	1 MHz	This is not applicable to IAB-DU and IAB-MT operating in Band n41.
E-UTRA Band 65 or NR Band n65	2110 – 2200 MHz	-52 dBm	1 MHz	
	1920 – 2010 MHz	-49 dBm	1 MHz	
E-UTRA Band 66 or NR Band n66	2110 – 2200 MHz	-52 dBm	1 MHz	
	1710 – 1780 MHz	-49 dBm	1 MHz	
E-UTRA Band 67 or NR Band n67	738 – 758 MHz	-52 dBm	1 MHz	
E-UTRA Band 68	753 -783 MHz	-52 dBm	1 MHz	
	698-728 MHz	-49 dBm	1 MHz	
E-UTRA Band 69	2570 – 2620 MHz	-52 dBm	1 MHz	
E-UTRA Band 70 or NR Band n70	1995 – 2020 MHz	-52 dBm	1 MHz	
	1695 – 1710 MHz	-49 dBm	1 MHz	
E-UTRA Band 71 or NR Band n71	617 – 652 MHz	-52 dBm	1 MHz	
	663 – 698 MHz	-49 dBm	1 MHz	
E-UTRA Band 72	461 – 466 MHz	-52 dBm	1 MHz	
	451 – 456 MHz	-49 dBm	1 MHz	
E-UTRA Band 74 or NR Band n74	1475 – 1518 MHz	-52 dBm	1 MHz	
	1427 – 1470 MHz	-49 dBm	1 MHz	
E-UTRA Band 75 or NR Band n75	1432 – 1517 MHz	-52 dBm	1 MHz	
E-UTRA Band 76 or NR Band n76	1427 – 1432 MHz	-52 dBm	1 MHz	
NR Band n77	3.3 – 4.2 GHz	-52 dBm	1 MHz	This requirement does not apply to IAB-DU and IAB-MT operating in Band n77 or n78
NR Band n78	3.3 – 3.8 GHz	-52 dBm	1 MHz	This requirement does not apply to IAB-DU and IAB-MT operating in Band n77 or n78
NR Band n79	4.4 – 5.0 GHz	-52 dBm	1 MHz	This requirement does not apply to IAB-DU and IAB-MT operating in Band n79
NR Band n80	1710 – 1785 MHz	-49 dBm	1 MHz	
NR Band n81	880 – 915 MHz	-49 dBm	1 MHz	
NR Band n82	832 – 862 MHz	-49 dBm	1 MHz	
NR Band n83	703 – 748 MHz	-49 dBm	1 MHz	
NR Band n84	1920 – 1980 MHz	-49 dBm	1 MHz	
E-UTRA Band 85 or NR Band n85	728 – 746 MHz	-52 dBm	1 MHz	
	698 – 716 MHz	-49 dBm	1 MHz	
NR Band n86	1710 – 1780 MHz	-49 dBm	1 MHz	
NR Band n89	824 – 849 MHz	-49 dBm	1 MHz	
NR Band n91	1427 – 1432 MHz	-52 dBm	1 MHz	
	832 – 862 MHz	-49 dBm	1 MHz	
NR Band n92	1432 – 1517 MHz	-52 dBm	1 MHz	
	832 – 862 MHz	-49 dBm	1 MHz	
NR Band n93	1427 – 1432 MHz	-52 dBm	1 MHz	
	880 – 915 MHz	-49 dBm	1 MHz	
NR Band n94	1432 – 1517 MHz	-52 dBm	1 MHz	
	880 – 915 MHz	-49 dBm	1 MHz	
NR Band n95	2010 – 2025 MHz	-52 dBm	1 MHz	
NR Band n96	5925 – 7125 MHz	-52 dBm	1 MHz	

NR Band n97	2300 – 2400MHz	-52 dBm	1 MHz	
NR Band n98	1880 – 1920MHz	-52 dBm	1 MHz	
NR Band n99	1626.5 – 1660.5 MHz	-49 dBm	1 MHz	
NR Band n100	919.4 – 925 MHz	-52 dBm	1 MHz	
	874.4 – 880 MHz	-49 dBm	1 MHz	
NR Band n101	1900 – 1910 MHz	-52 dBm	1 MHz	
NR Band n102	5925 – 6425 MHz	-52 dBm	1 MHz	
E-UTRA Band 103	757 – 758 MHz	-52 dBm	1 MHz	
	787 – 788 MHz	-49 dBm	1 MHz	
NR band n104	6425 – 7125 MHz	-52 dBm	1 MHz	

NOTE 1: As defined in the scope for spurious emissions in this clause the co-existence requirements in table 6.6.5.2.2-1 do not apply for the  $\Delta f_{\text{OBUE}}$  frequency range immediately outside the downlink *operating band* (see table 5.2-1). Emission limits for this excluded frequency range may be covered by local or regional requirements.

NOTE 2: Table 6.6.5.2.2-1 assumes that two *operating bands*, where the frequency ranges in table 5.2-1 would be overlapping, are not deployed in the same geographical area. For such a case of operation with overlapping frequency arrangements in the same geographical area, special co-existence requirements may apply that are not covered by the 3GPP specifications.

### 6.6.5.2.3 Co-location with base stations and IAB-Nodes

These requirements may be applied for the protection of other BS, IAB-DU or IAB-MT receivers when GSM900, DCS1800, PCS1900, GSM850, CDMA850, UTRA FDD, UTRA TDD, E-UTRA, NR BS, IAB-DU or IAB-MT are co-located with IAB-MT and/or IAB-DU.

The requirements assume a 30 dB coupling loss between transmitter and receiver and are based on co-location with same class.

The *basic limits* are in table 6.6.5.2.3-1 for an IAB-DU and IAB-MT. Requirements for co-location with a system listed in the first column apply, depending on the declared IAB-DU and IAB-MT class. For a *multi-band connector*, the exclusions and conditions in the Note column of table 6.6.5.2.3-1 shall apply for each supported *operating band*.

**Table 6.6.5.2.3-1: IAB-DU and IAB-MT spurious emissions *basic* limits for co-location with BS or IAB-Node**



Co-located system	Frequency range for co-location requirement	Basic limits			Measurement bandwidth	Note
		WA IAB-DU and WA IAB-MT	MR IAB-DU	LA IAB-DU and LA IAB-MT		
GSM900	876 – 915 MHz	-98 dBm	-91 dBm	-70 dBm	100 kHz	
DCS1800	1710 – 1785 MHz	-98 dBm	-91 dBm	-80 dBm	100 kHz	
PCS1900	1850 – 1910 MHz	-98 dBm	-91 dBm	-80 dBm	100 kHz	
GSM850 or CDMA850	824 – 849 MHz	-98 dBm	-91 dBm	-70 dBm	100 kHz	
UTRA FDD Band I or E-UTRA Band 1 or NR Band n1	1920 – 1980 MHz	-96 dBm	-91 dBm	-88 dBm	100 kHz	
UTRA FDD Band II or E-UTRA Band 2 or NR Band n2	1850 – 1910 MHz	-96 dBm	-91 dBm	-88 dBm	100 kHz	
UTRA FDD Band III or E-UTRA Band 3 or NR Band n3	1710 – 1785 MHz	-96 dBm	-91 dBm	-88 dBm	100 kHz	
UTRA FDD Band IV or E-UTRA Band 4	1710 – 1755 MHz	-96 dBm	-91 dBm	-88 dBm	100 kHz	
UTRA FDD Band V or E-UTRA Band 5 or NR Band n5	824 – 849 MHz	-96 dBm	-91 dBm	-88 dBm	100 kHz	
UTRA FDD Band VI, XIX or E-UTRA Band 6, 19	830 – 845 MHz	-96 dBm	-91 dBm	-88 dBm	100 kHz	
UTRA FDD Band VII or E-UTRA Band 7 or NR Band n7	2500 – 2570 MHz	-96 dBm	-91 dBm	-88 dBm	100 kHz	
UTRA FDD Band VIII or E-UTRA Band 8 or NR Band n8	880 – 915 MHz	-96 dBm	-91 dBm	-88 dBm	100 kHz	
UTRA FDD Band IX or E-UTRA Band 9	1749.9 – 1784.9 MHz	-96 dBm	-91 dBm	-88 dBm	100 kHz	
UTRA FDD Band X or E-UTRA Band 10	1710 – 1770 MHz	-96 dBm	-91 dBm	-88 dBm	100 kHz	
UTRA FDD Band XI or E-UTRA Band 11	1427.9 – 1447.9 MHz	-96 dBm	-91 dBm	-88 dBm	100 kHz	
UTRA FDD Band XII or E-UTRA Band 12 or NR Band n12	699 – 716 MHz	-96 dBm	-91 dBm	-88 dBm	100 kHz	
UTRA FDD Band XIII or E-UTRA Band 13	777 – 787 MHz	-96 dBm	-91 dBm	-88 dBm	100 kHz	
UTRA FDD Band XIV or E-UTRA Band 14 or NR Band n14	788 – 798 MHz	-96 dBm	-91 dBm	-88 dBm	100 kHz	
E-UTRA Band 17	704 – 716 MHz	-96 dBm	-91 dBm	-88 dBm	100 kHz	
E-UTRA Band 18 or NR Band n18	815 – 830 MHz	-96 dBm	-91 dBm	-88 dBm	100 kHz	
UTRA FDD Band XX or E-UTRA Band 20 or NR Band n20	832 – 862 MHz	-96 dBm	-91 dBm	-88 dBm	100 kHz	
UTRA FDD Band XXI or E-UTRA Band 21	1447.9 – 1462.9 MHz	-96 dBm	-91 dBm	-88 dBm	100 kHz	
UTRA FDD Band XXII or E-UTRA Band 22	3410 – 3490 MHz	-96 dBm	-91 dBm	-88 dBm	100 kHz	This is not applicable to IAB-DU and IAB-MT operating in Band n77 or n78
E-UTRA Band 23	2000 – 2020 MHz	-96 dBm	-91 dBm	-88 dBm	100 kHz	

E-UTRA Band 24	1626.5 – 1660.5 MHz	-96 dBm	-91 dBm	-88 dBm	100 kHz	
UTRA FDD Band XXV or E-UTRA Band 25 or NR Band n25	1850 – 1915 MHz	-96 dBm	-91 dBm	-88 dBm	100 kHz	
UTRA FDD Band XXVI or E-UTRA Band 26 or NR Band n26	814 – 849 MHz	-96 dBm	-91 dBm	-88 dBm	100 kHz	
E-UTRA Band 27	807 – 824 MHz	-96 dBm	-91 dBm	-88 dBm	100 kHz	
E-UTRA Band 28 or NR Band n28	703 – 748 MHz	-96 dBm	-91 dBm	-88 dBm	100 kHz	
E-UTRA Band 30 or NR Band n30	2305 – 2315 MHz	-96 dBm	-91 dBm	-88 dBm	100 kHz	
E-UTRA Band 31	452.5 – 457.5 MHz	-96 dBm	-91 dBm	-88 dBm	100 kHz	
UTRA TDD Band a) or E-UTRA Band 33	1900 – 1920 MHz	-96 dBm	-91 dBm	-88 dBm	100 kHz	
UTRA TDD Band a) or E-UTRA Band 34 or NR band n34	2010 – 2025 MHz	-96 dBm	-91 dBm	-88 dBm	100 kHz	
UTRA TDD Band b) or E-UTRA Band 35	1850 – 1910 MHz	-96 dBm	-91 dBm	-88 dBm	100 kHz	
UTRA TDD Band b) or E-UTRA Band 36	1930 – 1990 MHz	-96 dBm	-91 dBm	-88 dBm	100 kHz	
UTRA TDD Band c) or E-UTRA Band 37	1910 – 1930 MHz	-96 dBm	-91 dBm	-88 dBm	100 kHz	
UTRA TDD Band d) or E-UTRA Band 38 or NR Band n38	2570 – 2620 MHz	-96 dBm	-91 dBm	-88 dBm	100 kHz	
UTRA TDD Band f) or E-UTRA Band 39 or NR band n39	1880 – 1920MHz	-96 dBm	-91 dBm	-88 dBm	100 kHz	
UTRA TDD Band e) or E-UTRA Band 40 or NR Band n40	2300 – 2400MHz	-96 dBm	-91 dBm	-88 dBm	100 kHz	
E-UTRA Band 41 or NR Band n41, n90	2496 – 2690 MHz	-96 dBm	-91 dBm	-88 dBm	100 kHz	This is not applicable to IAB-DU and IAB-MT operating in Band n41
E-UTRA Band 42	3400 – 3600 MHz	-96 dBm	-91 dBm	-88 dBm	100 kHz	This is not applicable to IAB-DU and IAB-MT operating in Band n77 or n78
E-UTRA Band 43	3600 – 3800 MHz	-96 dBm	-91 dBm	-88 dBm	100 kHz	This is not applicable to IAB-DU and IAB-MT operating in Band n77 or n78
E-UTRA Band 44	703 – 803 MHz	-96 dBm	-91 dBm	-88 dBm	100 kHz	
E-UTRA Band 45	1447 – 1467 MHz	-96 dBm	-91 dBm	-88 dBm	100 kHz	
E-UTRA Band 46 or NR Band n46	5150 – 5925 MHz	N/A	-91 dBm	-88 dBm	100 kHz	
E-UTRA Band 48 or NR Band n48	3550 – 3700 MHz	-96 dBm	-91 dBm	-88 dBm	100 kHz	This is not applicable to IAB-DU and IAB-MT operating in Band n77 or n78
E-UTRA Band 50 or NR Band n50	1432 – 1517 MHz	-96 dBm	-91 dBm	-88 dBm	100 kHz	
E-UTRA Band 51 or NR Band n51	1427 – 1432 MHz	N/A	N/A	-88 dBm	100 kHz	

E-UTRA Band 53 or NR Band n53	2483.5 – 2495 MHz	N/A	-91 dBm	-88 dBm	100 kHz	This is not applicable to IAB-DU and IAB-MT operating in Band n41
E-UTRA Band 65 or NR Band n65	1920 – 2010 MHz	-96 dBm	-91 dBm	-88 dBm	100 kHz	
E-UTRA Band 66 or NR Band n66	1710 – 1780 MHz	-96 dBm	-91 dBm	-88 dBm	100 kHz	
E-UTRA Band 68	698 – 728 MHz	-96 dBm	-91 dBm	-88 dBm	100 kHz	
E-UTRA Band 70 or NR Band n70	1695 – 1710 MHz	-96 dBm	-91 dBm	-88 dBm	100 kHz	
E-UTRA Band 71 or NR Band n71	663 – 698 MHz	-96 dBm	-91 dBm	-88 dBm	100 kHz	
E-UTRA Band 72	451 – 456 MHz	-96 dBm	-91 dBm	-88 dBm	100 kHz	
E-UTRA Band 74 or NR Band n74	1427 – 1470 MHz	-96 dBm	-91 dBm	-88 dBm	100 kHz	
NR Band n77	3.3 – 4.2 GHz	-96 dBm	-91 dBm	-88 dBm	100 kHz	This is not applicable to IAB-DU and IAB-MT operating in Band n77 or n78
NR Band n78	3.3 – 3.8 GHz	-96 dBm	-91 dBm	-88 dBm	100 kHz	This is not applicable to IAB-DU and IAB-MT operating in Band n77 or n78
NR Band n79	4.4 – 5.0 GHz	-96 dBm	-91 dBm	-88 dBm	100 kHz	This is not applicable to IAB-DU and IAB-MT operating in Band n79
NR Band n80	1710 – 1785 MHz	-96 dBm	-91 dBm	-88 dBm	100 kHz	
NR Band n81	880 – 915 MHz	-96 dBm	-91 dBm	-88 dBm	100 kHz	
NR Band n82	832 – 862 MHz	-96 dBm	-91 dBm	-88 dBm	100 kHz	
NR Band n83	703 – 748 MHz	-96 dBm	-91 dBm	-88 dBm	100 kHz	
NR Band n84	1920 – 1980 MHz	-96 dBm	-91 dBm	-88 dBm	100 kHz	
E-UTRA Band 85 or NR Band n85	698 – 716 MHz	-96 dBm	-91 dBm	-88 dBm	100 kHz	
NR Band n86	1710 – 1780 MHz	-96 dBm	-91 dBm	-88 dBm	100 kHz	
NR Band n89	824 – 849 MHz	-96 dBm	-91 dBm	-88 dBm	100 kHz	
NR Band n91	832 – 862 MHz	N/A	N/A	-88 dBm	100 kHz	
NR Band n92	832 – 862 MHz	-96 dBm	-91 dBm	-88 dBm	100 kHz	
NR Band n93	880 – 915 MHz	N/A	N/A	-88 dBm	100 kHz	
NR Band n94	880 – 915 MHz	-96 dBm	-91 dBm	-88 dBm	100 kHz	
NR Band n95	2010 – 2025 MHz	-96 dBm	-91 dBm	-88 dBm	100 kHz	
NR Band n96	5925 – 7125 MHz	N/A	-90 dBm	-87 dBm	100 kHz	
NR Band n97	2300 – 2400MHz	-96 dBm	-91 dBm	-88 dBm	100 kHz	
NR Band n98	1880 – 1920MHz	-96 dBm	-91 dBm	-88 dBm	100 kHz	

NR Band n99	1626.5 – 1660.5 MHz	-96 dBm	-91 dBm	-88 dBm	100 kHz	
NR Band n102	5925 – 6425 MHz	N/A	-90 dBm	-87 dBm	100 kHz	
E-UTRA Band 103	787 – 788 MHz	-96 dBm	-91 dBm	-88 dBm	100 kHz	
NR Band n104	6425 – 7125 MHz	-95 dBm	-90 dBm	-87 dBm	100 kHz	

NOTE 1: As defined in the scope for spurious emissions in this clause, the co-location requirements in table 6.6.5.2.3-1 do not apply for the frequency range extending  $\Delta f_{\text{OBUE}}$  immediately outside the transmit frequency range of a IAB-MT and IAB-DU. The current state-of-the-art technology does not allow a single generic solution for co-location with other system on adjacent frequencies for 30dB antenna to antenna minimum coupling loss. However, there are certain site-engineering solutions that can be used. These techniques are addressed in TR 25.942 [4].

NOTE 2: Table 6.6.5.2.3-1 assumes that two *operating bands*, where the corresponding transmit and receive frequency ranges in table 5.2-1 would be overlapping, are not deployed in the same geographical area. For such a case of operation with overlapping frequency arrangements in the same geographical area, special co-location requirements may apply that are not covered by the 3GPP specifications.

### 6.6.5.3 Minimum requirements for IAB-DU and IAB-MT type 1-H

The Tx spurious emissions requirements for *IAB-DU type 1-H* and *IAB-MT type 1-H* are that for each *TAB connector TX min cell group* and each applicable *basic limit* in clause 6.6.5.2, the power summation of emissions at the *TAB connectors* of the *TAB connector TX min cell group* shall not exceed a limit specified as the *basic limit* + X, where  $X = 10\log_{10}(N_{\text{TXU, counted per cell}})$ , unless stated differently in regional regulation.

NOTE: Conformance to the *IAB-DU type 1-H* and *IAB-MT type 1-H* spurious emission requirement can be demonstrated by meeting at least one of the following criteria as determined by the manufacturer:

- 1) The sum of the emissions power measured on each *TAB connector* in the *TAB connector TX min cell group* shall be less than or equal to the limit as defined in this clause for the respective frequency span.
- Or
- 2) The unwanted emissions power at each *TAB connector* shall be less than or equal to the *type 1-H* limit as defined in this clause for the respective frequency span, scaled by  $-10\log_{10}(n)$ , where  $n$  is the number of *TAB connectors* in the *TAB connector TX min cell group*.

## 6.7 Transmitter intermodulation

### 6.7.1 General

The transmitter intermodulation requirement is a measure of the capability of the transmitter unit to inhibit the generation of signals in its non-linear elements caused by presence of the wanted signal and an interfering signal reaching the transmitter unit via the antenna, RDN and antenna array. The requirement shall apply during the *transmitter ON period* and the *transmitter transient period*.

For *IAB type 1-H*, the transmitter intermodulation level is the power of the intermodulation products when an interfering signal is injected into the *TAB connector*.

For *IAB type 1-H*, there are two types of transmitter intermodulation cases captured by the transmitter intermodulation requirement:

- 1) Co-location transmitter intermodulation in which the interfering signal is from a co-located base station or IAB.
- 2) Intra-system transmitter intermodulation in which the interfering signal is from other transmitter units within the *IAB type 1-H*.

For *IAB type 1-H*, the co-location transmitter intermodulation requirement is considered sufficient if the interference signal for the co-location requirement is higher than the declared interference signal for intra-system transmitter intermodulation requirement.

## 6.7.2 Minimum requirements for *IAB-DU type 1-H* and *IAB-MT type 1-H*

### 6.7.2.1 Co-location minimum requirements

The transmitter intermodulation level shall not exceed the unwanted emission limits in clauses 7.6 in the presence of an NR interfering signal according to table 6.7. 2.1-1

The requirement is applicable outside the *IAB RF Bandwidth edges*. The interfering signal offset is defined relative to the *IAB RF Bandwidth edges* or *Radio Bandwidth edges*.

For *TAB connectors* supporting operation in *non-contiguous spectrum*, the requirement is also applicable inside a *sub-block gap* for interfering signal offsets where the interfering signal falls completely within the *sub-block gap*. The interfering signal offset is defined relative to the *sub-block edges*.

For *multi-band connector*, the requirement shall apply relative to the *IAB RF Bandwidth edges* of each *operating band*. In case the *inter RF Bandwidth gap* is less than  $3 \cdot BW_{\text{Channel}}$  (where  $BW_{\text{Channel}}$  is the minimal *IAB-DU channel bandwidth* or *IAB-MT channel bandwidth* of the band), the requirement in the gap shall apply only for interfering signal offsets where the interfering signal falls completely within the *inter RF Bandwidth gap*.

**Table 6.7. 2.1-1: Interfering and wanted signals for the co-location transmitter intermodulation requirement**

Parameter	Value
Wanted signal type	NR single carrier, or multi-carrier, or multiple intra-band contiguously or non-contiguously aggregated carriers
Interfering signal type	NR signal, the minimum <i>IAB channel bandwidth</i> ( $BW_{\text{Channel}}$ ) with 15 kHz SCS of the band defined in clause 5.3.5.
Interfering signal level	<i>Rated total output power</i> per <i>TAB connector</i> ( $P_{\text{rated,t,TABC}}$ ) in the <i>operating band</i> – 30 dB
Interfering signal centre frequency offset from the lower/upper edge of the wanted signal or edge of <i>sub-block</i> inside a gap	$f_{\text{offset}} = \pm BW_{\text{Channel}} \left( n - \frac{1}{2} \right)$ , for $n=1, 2$ and 3
NOTE 1: Interfering signal positions that are partially or completely outside of any downlink <i>operating band</i> of the <i>TAB connector</i> are excluded from the requirement, unless the interfering signal positions fall within the frequency range of adjacent downlink <i>operating bands</i> in the same geographical area.	
NOTE 2: In Japan, NOTE 1 is not applied in Band n77, n78, n79.	

### 6.7.2.2 Intra-system minimum requirements

The transmitter intermodulation level shall not exceed the unwanted emission limits in clauses 6.6 in the presence of an NR interfering signal according to table 6.7. 2.2-1.

**Table 6.7.2.2-1: Interfering and wanted signals for intra-system transmitter intermodulation requirement**

Parameter	Value
Wanted signal type	NR signal
Interfering signal type	NR signal of the same IAB <i>channel bandwidth</i> and SCS as the wanted signal (Note 1).
Interfering signal level	Power level declared by the IAB manufacturer (Note 2).
Frequency offset between interfering signal and wanted signal	0 MHz
NOTE 1: The interfering signal shall be incoherent with the wanted signal.	
NOTE 2: The declared interfering signal power level at each <i>TAB connector</i> is the sum of the co-channel leakage power coupled via the combined RDN and Antenna Array from all the other <i>TAB connectors</i> , but does not comprise power radiated from the Antenna Array and reflected back from the environment. The power at each of the interfering <i>TAB connectors</i> is $P_{\text{rated,c,TABC}}$ .	

## 7 Conducted receiver characteristics

### 7.1 General

Conducted receiver characteristics are specified at *TAB connector* for IAB type 1-H, with full complement of transceivers for the configuration in normal operating condition.

Unless otherwise stated, the following arrangements apply for conducted receiver characteristics requirements in clause 7:

- Requirements apply during the receive period.
- Requirements shall be met for any transmitter setting.
- Throughput requirements defined for the conducted receiver characteristics do not assume HARQ retransmissions.
- When IAB-DU or IAB-MT is configured to receive multiple carriers, all the throughput requirements are applicable for each received carrier.
- For ACS, blocking and intermodulation characteristics, the negative offsets of the interfering signal apply relative to the lower *IAB RF Bandwidth* edge or *sub-block* edge inside a *sub-block gap*, and the positive offsets of the interfering signal apply relative to the upper *IAB RF Bandwidth* edge or *sub-block* edge inside a *sub-block gap*.

NOTE 1: In normal operating condition the IAB-DU and IAB-MT in TDD operation are configured to TX OFF power during *receive period*.

### 7.2 Reference sensitivity level

#### 7.2.1 IAB-DU reference sensitivity level

##### 7.2.1.1 General

The reference sensitivity power level  $P_{\text{REFSENS}}$  is the minimum mean power received at the *TAB connector* for IAB-DU type 1-H at which a throughput requirement shall be met for a specified reference measurement channel.

### 7.2.1.2 Minimum requirements for *IAB-DU type 1-H*

The wide area IAB-DU reference sensitivity level is specified the same as the wide area BS reference sensitivity level requirement for *BS type 1-H* in TS 38.104 [2], subclause 7.2.2, where references to *BS channel bandwidth* apply to *IAB-DU channel bandwidth*.

The medium range IAB-DU reference sensitivity level is specified the same as the medium range BS reference sensitivity level requirement for *BS type 1-H* in TS 38.104 [2], subclause 7.2.2, where references to *BS channel bandwidth* apply to *IAB-DU channel bandwidth*.

The local area IAB-DU reference sensitivity level is specified the same as the local area BS reference sensitivity level requirement for *BS type 1-H* in TS 38.104 [2], subclause 7.2.2, where references to *BS channel bandwidth* apply to *IAB-DU channel bandwidth*.

Referenced requirements applying to NB IoT are not applicable to the IAB-DU

## 7.2.2 IAB-MT reference sensitivity level

The throughput shall be  $\geq 95\%$  of the maximum throughput of the reference measurement channel as specified in annex A.1 with parameters specified in table 7.2.2-1 for Wide Area IAB-MT and in table 7.2.2-2 for Local Area IAB-MT.

**Table 7.2.2-1: Void**

**Table 7.2.2-2: Void**

### 7.2.2.1 General

The reference sensitivity power level  $P_{\text{REFSENS}}$  is the minimum mean power received at the *TAB connector* for *IAB-MT type 1-H* at which a throughput requirement shall be met for a specified reference measurement channel.

### 7.2.2.2 Minimum requirements for *IAB-MT type 1-H*

The throughput shall be  $\geq 95\%$  of the maximum throughput of the reference measurement channel as specified in annex A.1 with parameters specified in table 7.2.2.2-1 for Wide Area IAB-MT and in table 7.2.2.2-2 for Local Area IAB-MT.

**Table 7.2.2.2-1: Wide Area IAB-MT reference sensitivity levels**

IAB-MT channel bandwidth (MHz)	Sub-carrier spacing (kHz)	Reference measurement channel	Reference sensitivity power level, $P_{\text{REFSENS}}$ (dBm)
10, 15	30	G-FR1-A1-22 (Note 1)	-102.0
10, 15	60	G-FR1-A1-23 (Note 1)	-99.0
20, 25, 30, 35, 40, 45, 50, 60, 70, 80, 90, 100	30	G-FR1-A1-25 (Note 1)	-95.4
20, 25, 30, 35, 40, 45, 50, 60, 70, 80, 90, 100	60	G-FR1-A1-26 (Note 1)	-95.6

NOTE 1:  $P_{\text{REFSENS}}$  is the power level of a single instance of the reference measurement channel. This requirement shall be met for each consecutive application of a single instance of the reference measurement channel mapped to disjoint frequency ranges with a width corresponding to the number of resource blocks of the reference measurement channel each, except for one instance that might overlap one other instance to cover the full *IAB-MT channel bandwidth*.

Table 7.2.2.2-2: Local Area IAB-MT reference sensitivity levels

IAB-MT channel bandwidth (MHz)	Sub-carrier spacing (kHz)	Reference measurement channel	Reference sensitivity power level, $P_{\text{REFSENS}}$ (dBm)
10, 15	30	G-FR1-A1-22 (Note 1)	-94.0
10, 15	60	G-FR1-A1-23 (Note 1)	-91.0
20, 25, 30, 35, 40, 45, 50, 60, 70, 80, 90, 100	30	G-FR1-A1-25 (Note 1)	-87.4
20, 25, 30, 35, 40, 45, 50, 60, 70, 80, 90, 100	60	G-FR1-A1-26 (Note 1)	-87.6

NOTE 1:  $P_{\text{REFSENS}}$  is the power level of a single instance of the reference measurement channel. This requirement shall be met for each consecutive application of a single instance of the reference measurement channel mapped to disjoint frequency ranges with a width corresponding to the number of resource blocks of the reference measurement channel each, except for one instance that might overlap one other instance to cover the full IAB-MT channel bandwidth.

## 7.3 Dynamic range

### 7.3.1 IAB-DU dynamic range

#### 7.3.1.1 General

The dynamic range is specified as a measure of the capability of the receiver to receive a wanted signal in the presence of an interfering signal at the *TAB connector* for IAB-DU type 1-H inside the received IAB-DU channel bandwidth. In this condition, a throughput requirement shall be met for a specified reference measurement channel. The interfering signal for the dynamic range requirement is an AWGN signal.

#### 7.3.1.2 Minimum requirement for IAB-DU type 1-H

The wide area IAB-DU dynamic range is specified the same as the wide area BS dynamic requirement for BS type 1-H in TS 38.104 [2], subclause 7.3.2, where references to BS channel bandwidth apply to IAB-DU channel bandwidth.

The medium range IAB-DU dynamic range is specified the same as the medium range BS dynamic range requirement for BS type 1-H in TS 38.104 [2], subclause 7.3.2, where references to BS channel bandwidth apply to IAB-DU channel bandwidth.

The local area IAB-DU dynamic range is specified the same as the local area BS dynamic range requirement for BS type 1-H in TS 38.104 [2], subclause 7.3.2, where references to BS channel bandwidth apply to IAB-DU channel bandwidth.

Referenced requirements applying to NB IoT are not applicable to the IAB-DU

## 7.4 In-band selectivity and blocking

### 7.4.1 Adjacent Channel Selectivity (ACS)

#### 7.4.1.1 General

Adjacent channel selectivity (ACS) is a measure of the receiver's ability to receive a wanted signal at its assigned channel frequency at the *TAB connector* for IAB-MT type 1-H or IAB-DU type 1-H in the presence of an adjacent channel signal with a specified centre frequency offset of the interfering signal to the band edge of a victim system.



### 7.4.1.2 Minimum requirement for *IAB-DU type 1-H*

Minimum requirement is the same as specified for BS type 1-H in TS38.104[2], subclause 7.4.1.2.

### 7.4.1.3 Minimum requirement for *IAB-MT type 1-H*

The throughput shall be  $\geq 95\%$  of the maximum throughput of the reference measurement channel.

For IAB-MT, the wanted and the interfering signal coupled to the *IAB-MT type 1-H TAB connector* are specified in table 7.4.1.3-1 and the frequency offset between the wanted and interfering signal in table 7.4.1.3-2 for ACS. The reference measurement channel for the wanted signal is identified in table 7.2.2-1 and 7.2.2-2 for each *IAB-MT channel bandwidth* and further specified in annex A.1. The characteristics of the interfering signal is further specified in annex F.

The ACS requirement is applicable outside the *IAB-MT RF Bandwidth* or *Radio Bandwidth*. The interfering signal offset is defined relative to the *IAB-MT RF Bandwidth* edges or *Radio Bandwidth* edges.

For IAB-MT operating in *non-contiguous spectrum* within any *operating band*, the ACS requirement shall apply in addition inside any *sub-block gap*, in case the *sub-block gap size* is at least as wide as the NR interfering signal in table 7.4.1.3-2. The interfering signal offset is defined relative to the *sub-block* edges inside the *sub-block gap*.

For a *multi-band connector*, the ACS requirement shall apply in addition inside any *Inter RF Bandwidth gap*, in case the *Inter RF Bandwidth gap size* is at least as wide as the NR interfering signal in table 7.4.1.3-2. The interfering signal offset is defined relative to the *IAB-MT RF Bandwidth* edges inside the *Inter RF Bandwidth gap*.

Minimum conducted requirement is defined at the *TAB connector* for *IAB-MT type 1-H*.

**Table 7.4.1.3-1: ACS requirement for IAB-MT**

<b><i>IAB-MT channel bandwidth of the lowest/highest carrier received (MHz)</i></b>	<b>Wanted signal mean power (dBm)</b>	<b>Interfering signal mean power (dBm)</b>
10, 15, 20, 25, 30, 35, 40, 45, 50, 60, 70, 80, 90, 100 (Note 1)	$P_{\text{REFSENS}} + 6 \text{ dB}$	Wide Area IAB-MT: -52 Local Area IAB-MT: -44
NOTE 1: The SCS for the lowest/highest carrier received is the lowest SCS supported by the IAB-MT for that bandwidth.		

Table 7.4.1.3-2: IAB-MT ACS interferer frequency offset values

<i>IAB-MT channel bandwidth of the lowest/highest carrier received (MHz)</i>	<i>Interfering signal centre frequency offset from the lower/upper IAB-MT RF Bandwidth edge or sub-block edge inside a sub-block gap (MHz)</i>	<i>Type of interfering signal</i>
10	±2.5075	5 MHz CP-OFDM NR signal 15 kHz SCS, 25 RBs
15	±2.5125	
20	±2.5025	
25	±9.4675	20 MHz CP-OFDM NR signal 15 kHz SCS, 100 RBs
30	±9.4725	
35	±9.4625	
40	±9.4675	
45	±9.4725	
50	±9.4625	
60	±9.4725	
70	±9.4675	
80	±9.4625	
90	±9.4725	
100	±9.4675	

## 7.4.2 In-band blocking

### 7.4.2.1 General

The in-band blocking characteristics is a measure of the receiver's ability to receive a wanted signal at its assigned channel at the *TAB connector* for *IAB-DU type 1-H* and *IAB-MT type 1-H* in the presence of an unwanted interferer, which is an NR signal for general blocking or an NR signal with one resource block for narrowband blocking.

### 7.4.2.2 Minimum requirement for IAB-DU type 1-H

Minimum requirement is the same as specified for BS type 1-H in TS38.104[2], subclause 7.4.2.2.

### 7.4.2.3 Minimum requirement for IAB-MT type 1-H

The throughput shall be  $\geq 95\%$  of the maximum throughput of the reference measurement channel, with a wanted and an interfering signal coupled to *IAB-MT type 1-H TAB connector* using the parameters in tables 7.4.2.3-1, 7.4.2.3-2 and 7.4.2.3-3 for general blocking and narrowband blocking requirements. The reference measurement channel for the wanted signal is identified in clause 7.2.2 for each *IAB-MT channel bandwidth* and further specified in annex A.1. The characteristics of the interfering signal is further specified in annex F.

The in-band blocking requirements apply outside the *IAB-MT RF Bandwidth* or *Radio Bandwidth*. The interfering signal offset is defined relative to the *IAB-MT RF Bandwidth edges* or *Radio Bandwidth edges*.

The in-band blocking requirement shall apply from  $F_{DL,low} - \Delta f_{OOB}$  to  $F_{DL,high} + \Delta f_{OOB}$ . The  $\Delta f_{OOB}$  for *wide area IAB-MT type 1-H* is defined in table 7.4.2.3-0.

Minimum conducted requirement is defined at the *TAB connector* for *IAB-MT type 1-H*.

Table 7.4.2.3-0:  $\Delta f_{OOB}$  offset for NR operating bands

<i>IAB-MT type</i>	<i>Operating band characteristics</i>	<i><math>\Delta f_{OOB}</math> (MHz)</i>
<i>IAB-MT type 1-H</i>	$F_{DL,high} - F_{DL,low} < 100$ MHz	20
	$100$ MHz $\leq F_{DL,high} - F_{DL,low} \leq 900$ MHz	60

For an IAB-MT operating in *non-contiguous spectrum* within any *operating band*, the in-band blocking requirements apply in addition inside any *sub-block gap*, in case the *sub-block gap* size is at least as wide as twice the interfering signal minimum offset in tables 7.4.2.3-1. The interfering signal offset is defined relative to the *sub-block* edges inside the *sub-block gap*.

For a *multi-band connector*, the blocking requirements apply in the in-band blocking frequency ranges for each supported *operating band*. The requirement shall apply in addition inside any *Inter RF Bandwidth gap*, in case the *Inter RF Bandwidth gap* size is at least as wide as twice the interfering signal minimum offset in tables 7.4.2.3-1.

For an IAB-MT operating in *non-contiguous spectrum* within any *operating band*, the narrowband blocking requirement shall apply in addition inside any *sub-block gap*, in case the *sub-block gap* size is at least as wide as the *channel bandwidth* of the NR interfering signal in Table 7.4.2.3-3. The interfering signal offset is defined relative to the *sub-block* edges inside the *sub-block gap*.

For a *multi-band connector*, the narrowband blocking requirement shall apply in addition inside any *Inter RF Bandwidth gap*, in case the *Inter RF Bandwidth gap* size is at least as wide as the NR interfering signal in Table 7.4.2.3-3. The interfering signal offset is defined relative to the *IAB-MT RF Bandwidth* edges inside the *Inter RF Bandwidth gap*.

**Table 7.4.2.3-1: IAB-MT general blocking requirement**

<b>IAB-MT channel bandwidth of the lowest/highest carrier received (MHz)</b>	<b>Wanted signal mean power (dBm)</b>	<b>Interfering signal mean power (dBm)</b>	<b>Interfering signal centre frequency minimum offset from the lower/upper IAB-MT RF Bandwidth edge or sub-block edge inside a sub-block gap (MHz)</b>	<b>Type of interfering signal</b>
10, 15, 20	$P_{\text{REFSENS}} + 6$ dB	Wide Area IAB-MT: -43 Local Area IAB-MT: -35	$\pm 7.5$	5 MHz CP-OFDM NR signal 15 kHz SCS, 25 RBs
25, 30, 35, 40, 45, 50, 60, 70, 80, 90, 100	$P_{\text{REFSENS}} + 6$ dB	Wide Area IAB-MT: -43 Local Area IAB-MT: -35	$\pm 30$	20 MHz CP-OFDM NR signal 15 kHz SCS, 100 RBs
NOTE: $P_{\text{REFSENS}}$ depends on the RAT. For NR, $P_{\text{REFSENS}}$ depends also on the IAB-MT <i>channel bandwidth</i> as specified in tables 7.2.2-1, 7.2.2-2.				

**Table 7.4.2.3-2: IAB-MT narrowband blocking requirement**

<b>IAB-MT channel bandwidth of the lowest/highest carrier received (MHz)</b>	<b>Wanted signal mean power (dBm)</b>	<b>Interfering signal mean power (dBm)</b>
10, 15, 20, 25, 30, 35, 40, 45, 50, 60, 70, 80, 90, 100 (Note 1)	$P_{\text{REFSENS}} + 6$ dB	Wide Area IAB-MT: -49 Local Area IAB-MT: -41
NOTE 1: The SCS for the <i>lowest/highest carrier</i> received is the lowest SCS supported by the IAB-MT for that IAB-MT <i>channel bandwidth</i>		
NOTE 2: $P_{\text{REFSENS}}$ depends on the IAB-MT <i>channel bandwidth</i> as specified in tables 7.2.2-1 and 7.2.2-2.		
NOTE 3: 7.5 kHz shift is not applied to the wanted signal.		

Table 7.4.2.3-3: IAB-MT narrowband blocking interferer frequency offsets

IAB-MT channel bandwidth of the lowest/highest carrier received (MHz)	Interfering RB centre frequency offset to the lower/upper IAB-MT RF Bandwidth edge or sub-block edge inside a sub-block gap (kHz) (Note 2)	Type of interfering signal	
		5 MHz CP-OFDM NR signal, 15 kHz SCS, 1 RB	
10	$\pm(355+m*180)$ , m=0, 1, 2, 3, 4, 9, 14, 19, 24		
15	$\pm(360+m*180)$ , m=0, 1, 2, 3, 4, 9, 14, 19, 24		
20	$\pm(350+m*180)$ , m=0, 1, 2, 3, 4, 9, 14, 19, 24		
25	$\pm(565+m*180)$ , m=0, 1, 2, 3, 4, 29, 54, 79, 99	20 MHz CP-OFDM NR signal, 15 kHz SCS, 1 RB	
30	$\pm(570+m*180)$ , m=0, 1, 2, 3, 4, 29, 54, 79, 99		
35	$\pm(560+m*180)$ , m=0, 1, 2, 3, 4, 29, 54, 79, 99		
40	$\pm(565+m*180)$ , m=0, 1, 2, 3, 4, 29, 54, 79, 99		
50	$\pm(560+m*180)$ , m=0, 1, 2, 3, 4, 29, 54, 79, 99		
45	$\pm(570+m*180)$ , m=0, 1, 2, 3, 4, 29, 54, 79, 99		
60	$\pm(570+m*180)$ , m=0, 1, 2, 3, 4, 29, 54, 79, 99		
70	$\pm(565+m*180)$ , m=0, 1, 2, 3, 4, 29, 54, 79, 99		
80	$\pm(560+m*180)$ , m=0, 1, 2, 3, 4, 29, 54, 79, 99		
90	$\pm(570+m*180)$ , m=0, 1, 2, 3, 4, 29, 54, 79, 99		
100	$\pm(565+m*180)$ , m=0, 1, 2, 3, 4, 29, 54, 79, 99		
NOTE 1: Interfering signal consisting of one resource block positioned at the stated offset, the <i>channel bandwidth</i> of the interfering signal is located adjacently to the lower/upper IAB-MT <i>RF Bandwidth edge</i> or <i>sub-block edge</i> inside a <i>sub-block gap</i> .			
NOTE 2: The centre of the interfering RB refers to the frequency location between the two central subcarriers.			

## 7.5 Out-of-band blocking

### 7.5.1 General

The out-of-band blocking characteristics is a measure of the receiver ability to receive a wanted signal at its assigned channel at the *TAB connector* for *IAB-DU type 1-H* and *IAB-MT type 1-H* in the presence of an unwanted interferer out of the *operating band*, which is a CW signal for out-of-band blocking.

### 7.5.2 Void

### 7.5.3 Minimum requirement for IAB-DU type 1-H

Minimum requirement is the same as specified for BS type 1-H in TS 38.104 [2], subclause 7.5.2.

### 7.5.4 Co-location minimum requirements for IAB-DU type 1-H

Minimum requirement is the same as specified for BS type 1-H in TS 38.104 [2], subclause 7.5.3.

### 7.5.5 Minimum requirement for IAB-MT type 1-H

The throughput shall be  $\geq 95\%$  of the maximum throughput of the reference measurement channel, with a wanted and an interfering signal coupled to *IAB-Node type 1-H TAB connector* using the parameters in table 7.5.5-2. The reference measurement channel for the wanted signal is identified in subclause 7.2.1 and subclause 7.2.2 for each *IAB-Node channel bandwidth* and further specified in annex A.1.

The out-of-band blocking requirement apply from 1 MHz to  $F_{DL,low} - \Delta f_{OOB}$  and from  $F_{DL,high} + \Delta f_{OOB}$  up to 12750 MHz. The  $\Delta f_{OOB}$  for *IAB-MT type 1-H* is defined in table 7.5.5-1.

**Table 7.5.5-1:  $\Delta f_{OOB}$  offset for NR operating bands**

IAB-MT type	Operating band characteristics	$\Delta f_{OOB}$ (MHz)
type 1-H	$F_{DL,high} - F_{DL,low} < 100$ MHz	20
	$100 \text{ MHz} \leq F_{DL,high} - F_{DL,low} \leq 900$ MHz	60

Minimum conducted requirement is defined and at the *TAB connector* for *IAB-MT type 1-H*.

For a *multi-band connector*, the requirement in the out-of-band blocking frequency ranges apply for each *operating band*, with the exception that the in-band blocking frequency ranges of all supported *operating bands* according to clause 7.4.2.2 shall be excluded from the out-of-band blocking requirement.

**Table 7.5.5-2: Out-of-band blocking performance requirement for NR**

Wanted Signal mean power (dBm)	Interfering Signal mean power (dBm)	Type of Interfering Signal
$P_{\text{REFSENS}} + 6$ dB (Note)	-15	CW carrier
NOTE 1: For NR, $P_{\text{REFSENS}}$ depends also on the <i>IAB-MT channel bandwidth</i> as specified in subclause 7.2.1 and subclause 7.2.2.		

### 7.5.6 Co-location minimum requirements for IAB-MT type 1-H

This additional blocking requirement may be applied for the protection of IAB-MT receivers when GSM, CDMA, UTRA, E-UTRA, NR BS or IAB-Node operating in a different frequency band are co-located with an IAB Node. The requirement is applicable to all *IAB-MT channel bandwidths* supported by the IAB Node.

The requirements in this clause assume a 30 dB coupling loss between interfering transmitter and IAB Node receiver and are based on co-location with base stations of the same class.

The throughput shall be  $\geq 95\%$  of the maximum throughput of the reference measurement channel, with a wanted and an interfering signal coupled to *IAB type 1-H TAB connector* input using the parameters in table 7.5.6-1 for all the IAB Node classes. The reference measurement channel for the wanted signal is identified in subclause 7.2.1 and subclause 7.2.2 for each *IAB-MT channel bandwidth* and further specified in annex A.1.

The blocking requirement for co-location with BS or IAB-Node in other bands is applied for all *operating bands* for which co-location protection is provided.

Minimum conducted requirement is defined at the *TAB connector* for *IAB-MT type 1-H*.

Table 7.5.6-1: Blocking performance requirement for the IAB Node

Frequency range of interfering signal	Wanted signal mean power (dBm)	Interfering signal mean power for WA IAB Node (dBm)	Interfering signal mean power for LA IAB Node (dBm)	Type of interfering signal
Frequency range of co-located downlink <i>operating band</i>	$P_{\text{REFSENS}} + 6\text{dB}$ (Note 1)	+16	x (Note 2)	CW carrier
NOTE 1: $P_{\text{REFSENS}}$ depends on the <i>IAB-MT channel bandwidth</i> as specified in subclause 7.2.1 and subclause 7.2.2.				
NOTE 2: x = -7 dBm for IAB-MT co-located with Pico GSM850 or Pico CDMA850 x = -4 dBm for IAB-MT co-located with Pico DCS1800 or Pico PCS1900 x = -6 dBm for IAB-MT co-located with UTRA bands or E-UTRA bands or NR bands				
NOTE 3: The requirement does not apply when the interfering signal falls within any of the supported downlink <i>operating band(s)</i> or in $\Delta f_{\text{OoB}}$ immediately outside any of the supported downlink <i>operating band(s)</i> .				

## 7.6 Receiver spurious emissions

### 7.6.1 General

The receiver spurious emissions power is the power of emissions generated or amplified in a receiver unit that appear at the *TAB connector* (for *IAB-DU type 1-H* and *IAB-MT type 1-H*). The requirements apply to all IAB-DU and IAB-MT with separate RX and TX *TAB connectors*.

For *TAB connectors* supporting both RX and TX in TDD, the requirements apply during the *transmitter OFF period*.

For RX-only *multi-band connectors*, the spurious emissions requirements are subject to exclusion zones in each supported *operating band*. For *multi-band connectors* that both transmit and receive in *operating band* supporting TDD, RX spurious emissions requirements are applicable during the *TX OFF period*, and are subject to exclusion zones in each supported *operating band*.

For *IAB-DU type 1-H* and *IAB-MT type 1-H* manufacturer shall declare *TAB connector RX min cell groups*. The declaration is done separately for IAB-DU and IAB-MT. Every *TAB connector* of *IAB-DU type 1-H* and *IAB-MT type 1-H* supporting reception in an *operating band* shall map to one *TAB connector RX min cell group*, where mapping of *TAB connectors* to cells/beams is implementation dependent.

The number of active receiver units that are considered when calculating the conducted RX spurious emission limits ( $N_{\text{RXU,counted}}$ ) for *IAB-DU type 1-H* and *IAB-MT type 1-H* is calculated as follows:

$$N_{\text{RXU,counted}} = \min(N_{\text{RXU,active}}, 8 \times N_{\text{cells}})$$

$N_{\text{RXU,countedpercell}}$  is used for scaling of *basic limits* and is derived as  $N_{\text{RXU,countedpercell}} = N_{\text{RXU,counted}} / N_{\text{cells}}$ , where  $N_{\text{cells}}$  is defined in clause 6.1.

NOTE:  $N_{\text{RXU,active}}$  is the number of actually active receiver units and is independent to the declaration of  $N_{\text{cells}}$ .

### 7.6.2 IAB-DU receiver spurious emissions

#### 7.6.2.1 Basic limits

The receiver spurious emissions *basic limits* are provided in table 7.6.2.1-1.

Table 7.6.2.1-1: General IAB-DU receiver spurious emissions limits

Spurious frequency range	Basic limits	Measurement bandwidth	Note
30 MHz – 1 GHz	-57 dBm	100 kHz	Note 1
1 GHz – 12.75 GHz	-47 dBm	1 MHz	Note 1, Note 2
12.75 GHz – 5 <sup>th</sup> harmonic of the upper frequency edge of the UL <i>operating band</i> in GHz	-47 dBm	1 MHz	Note 1, Note 2, Note 3
NOTE 1: <i>Measurement bandwidths</i> as in ITU-R SM.329 [16], s4.1. NOTE 2: Upper frequency as in ITU-R SM.329 [16], s2.5 table 1. NOTE 3: This spurious frequency range applies only for <i>operating bands</i> for which the 5 <sup>th</sup> harmonic of the upper frequency edge of the UL <i>operating band</i> is reaching beyond 12.75 GHz. NOTE 4: The frequency range from $\Delta f_{\text{OBUE}}$ below the lowest frequency of the IAB transmitter <i>operating band</i> to $\Delta f_{\text{OBUE}}$ above the highest frequency of the IAB transmitter <i>operating band</i> may be excluded from the requirement. $\Delta f_{\text{OBUE}}$ is defined in clause [6.6.1]. For <i>multi-band connectors</i> , the exclusion applies for all supported <i>operating bands</i> .			

### 7.6.2.2 Minimum requirement for IAB-DU type 1-H

The RX spurious emissions requirements for *IAB-DU type 1-H* are that for each applicable *basic limit* specified in table 7.6.2.1-1 for each *TAB connector RX min cell group*, the power sum of emissions at respective *TAB connectors* shall not exceed the BS limits specified as the *basic limits* + X, where  $X = 10\log_{10}(N_{\text{RXU, counted per cell}})$ , unless stated differently in regional regulation.

The RX spurious emission requirements are applied per the *TAB connector RX min cell group* for all the configurations supported by the BS.

NOTE: Conformance to the IAB-DU receiver spurious emissions requirement can be demonstrated by meeting at least one of the following criteria as determined by the manufacturer:

- 1) The sum of the spurious emissions power measured on each *TAB connector* in the *TAB connector RX min cell group* shall be less than or equal to the IAB-DU limit above for the respective frequency span.

Or

- 2) The spurious emissions power at each *TAB connector* shall be less than or equal to the IAB-DU limit as defined above for the respective frequency span, scaled by  $-10\log_{10}(n)$ , where  $n$  is the number of *TAB connectors* in the *TAB connector RX min cell group*.

## 7.6.3 IAB-MT receiver spurious emissions

### 7.6.3.1 Basic limits

The IAB-MT receiver spurious emissions *basic limits* are provided in table 7.6.3.1-1.

Table 7.6.3.1-1: General IAB-MT receiver spurious emissions limits

Spurious frequency range	Basic limits	Measurement bandwidth	Note
30 MHz – 1 GHz	-57 dBm	100 kHz	Note 1
1 GHz – 12.75 GHz	-47 dBm	1 MHz	Note 1, Note 2
12.75 GHz – 5 <sup>th</sup> harmonic of the upper frequency edge of the DL <i>operating band</i> in GHz	-47 dBm	1 MHz	Note 1, Note 2, Note 3
NOTE 1: <i>Measurement bandwidths</i> as in ITU-R SM.329 [16], s4.1. NOTE 2: Upper frequency as in ITU-R SM.329 [16], s2.5 table 1. NOTE 3: This spurious frequency range applies only for <i>operating bands</i> for which the 5 <sup>th</sup> harmonic of the upper frequency edge of the DL <i>operating band</i> is reaching beyond 12.75 GHz. NOTE 4: The frequency range from $\Delta f_{\text{OBUE}}$ below the lowest frequency of the IAB-MT transmitter <i>operating band</i> to $\Delta f_{\text{OBUE}}$ above the highest frequency of the IAB-MT transmitter <i>operating band</i> may be excluded from the requirement. $\Delta f_{\text{OBUE}}$ is defined in clause [6.6.1]. For <i>multi-band connectors</i> , the exclusion applies for all supported <i>operating bands</i> .			

### 7.6.3.2 Minimum requirement for IAB-MT type 1-H

The RX spurious emissions requirements for *IAB-MT type 1-H* are that for each applicable *basic limit* specified in table 7.6.3.1-1 for each *TAB connector RX min cell group*, the power sum of emissions at respective *TAB connectors* shall not exceed the IAB-MT limits specified as the *basic limits* + X, where  $X = 10\log_{10}(N_{\text{RXU, counted per cell}})$ , unless stated differently in regional regulation.

The RX spurious emission requirements are applied per the *TAB connector RX min cell group* for all the configurations supported by the IAB-MT.

NOTE: Conformance to the IAB-MT receiver spurious emissions requirement can be demonstrated by meeting at least one of the following criteria as determined by the manufacturer:

- 1) The sum of the spurious emissions power measured on each *TAB connector* in the *TAB connector RX min cell group* shall be less than or equal to the IAB-MT limit above for the respective frequency span.

Or

- 2) The spurious emissions power at each *TAB connector* shall be less than or equal to the IAB-MT limit as defined above for the respective frequency span, scaled by  $-10\log_{10}(n)$ , where  $n$  is the number of *TAB connectors* in the *TAB connector RX min cell group*.

## 7.7 Receiver intermodulation

### 7.7.1 General

Third and higher order mixing of the two interfering RF signals can produce an interfering signal in the band of the desired channel. Intermodulation response rejection is a measure of the capability of the receiver to receive a wanted signal on its assigned channel frequency at *TAB connector* for IAB-DU type 1-H [and IAB-MT type 1-H] in the presence of two interfering signals which have a specific frequency relationship to the wanted signal.

### 7.7.2 Minimum requirement for *IAB-DU type 1-H*

The Wide Area IAB-DU receiver intermodulation requirement is specified the same as the Wide Area receiver intermodulation requirement for BS *type 1-H* in TS 38.104[2], subclause 7.7.2, where references to *BS channel bandwidth* apply to *IAB-DU channel bandwidth*.



The Medium Range IAB-DU receiver intermodulation requirement is specified the same as the Medium Range BS receiver intermodulation requirement for BS *type 1-H* in TS 38.104[2], subclause 7.7.2, where references to *BS channel bandwidth* apply to *IAB-DU channel bandwidth*.

The Local Area IAB-DU receiver intermodulation requirement is specified the same as the Local Area BS receiver intermodulation requirement for BS *type 1-H* in TS 38.104[2], subclause 7.7.2, where references to *BS channel bandwidth* apply to *IAB-DU channel bandwidth*.

Referenced requirements applying to NB-IoT are not applicable to the IAB-DU

### 7.7.3 Minimum requirement for *IAB-MT type 1-H*

The Wide Area IAB-MT receiver intermodulation requirement is specified the same as the Wide Area receiver intermodulation requirement for BS *type 1-H* in TS 38.104[2], subclause 7.7.2, where references to *BS channel bandwidth* apply to *IAB-MT channel bandwidth*.

The Local Area IAB-MT receiver intermodulation requirement is specified the same as the Local Area BS receiver intermodulation requirement for BS *type 1-H* in TS 38.104[2], subclause 7.7.2, where references to *BS channel bandwidth* apply to *IAB-MT channel bandwidth*.

Interfering signal for IAB-MT *type 1-H* should be CP-OFDM

## 7.8 In-channel selectivity

### 7.8.1 General

In-channel selectivity (ICS) is a measure of the receiver ability to receive a wanted signal at its assigned resource block locations *TAB connector* for *IAB-DU type 1-H* in the presence of an interfering signal received at a larger power spectral density. In this condition a throughput requirement shall be met for a specified reference measurement channel. The interfering signal shall be an NR signal which is time aligned with the wanted signal.

### 7.8.2 Minimum requirement for *IAB-DU type 1-H*

The wide area IAB-DU receiver in-channel selectivity requirement is specified the same as the wide area receiver in-channel selectivity requirement for BS *type 1-H* in TS 38.104[2], subclause 7.8.2, where references to *BS channel bandwidth* apply to *IAB-DU channel bandwidth*.

The medium range IAB-DU receiver in-channel selectivity requirement is specified the same as the medium range BS receiver in-channel selectivity requirement for BS *type 1-H* in TS 38.104[2], subclause 7.8.2, where references to *BS channel bandwidth* apply to *IAB-DU channel bandwidth*.

The local area IAB-DU receiver in-channel selectivity requirement is specified the same as the local area BS receiver in-channel selectivity requirement for BS *type 1-H* in TS 38.104[2], subclause 7.8.2, where references to *BS channel bandwidth* apply to *IAB-DU channel bandwidth*.

Referenced requirements applying to NB-IoT are not applicable to the IAB-DU

---

## 8 Conducted performance requirements

### 8.1 IAB-DU performance requirements

#### 8.1.1 General

Conducted performance requirements specify the ability of the IAB type 1-H to correctly demodulate signals in various conditions and configurations. Conducted performance requirements are specified at the *TAB connector(s)*.

Conducted performance requirements for the IAB-DU are specified for the fixed reference channels defined in annex A and the propagation conditions in annex I. The requirements only apply to those FRCs that are supported by the IAB-DU.

Unless stated otherwise, performance requirements apply for a single carrier only. Performance requirements for an IAB-DU supporting carrier aggregation are defined in terms of single carrier requirements.

The SNR used in this clause is specified based on a single carrier and defined as:

$$\text{SNR} = S / N$$

Where:

$S$  is the total signal energy in the slot on a single TAB connector.

$N$  is the noise energy in a bandwidth corresponding to the transmission bandwidth over the duration of a slot on a single TAB connector.

## 8.1.2 Performance requirements for PUSCH

### 8.1.2.1 Requirements for PUSCH with transform precoding disabled

#### 8.1.2.1.1 General

The performance requirement of PUSCH is determined by a minimum required throughput for a given SNR. The required throughput is expressed as a fraction of maximum throughput for the FRCs listed in annex A. The performance requirements assume HARQ retransmissions.

**Table 8.1.2.1-1: Test parameters for testing PUSCH**

Parameter		Value
Transform precoding		Disabled
Default TDD UL-DL pattern (Note 1)		15 kHz SCS: 3D1S1U, S=10D:2G:2U 30 kHz SCS: 7D1S2U, S=6D:4G:4U
Cyclic prefix		Normal
HARQ	Maximum number of HARQ transmissions	4
	RV sequence	0, 2, 3, 1
DM-RS	DM-RS configuration type	1
	DM-RS duration	single-symbol DM-RS
	Additional DM-RS position	pos1
	Number of DM-RS CDM group(s) without data	2
	Ratio of PUSCH EPRE to DM-RS EPRE	-3 dB
	DM-RS port	{0}, {0, 1}
DM-RS sequence generation		$N_{ID}^0=0, n_{SCID}=0$
Time domain resource assignment	PUSCH mapping type	A, B
	Start symbol	0
	Allocation length	14
Frequency domain resource assignment	RB assignment	Full applicable test bandwidth
	Frequency hopping	Disabled
TPMI index for 2Tx two-layer spatial multiplexing transmission		0
Code block group based PUSCH transmission		Disabled
NOTE 1: The same requirements are applicable to different UL-DL patterns.		

#### 8.1.2.1.1 Minimum requirements

The throughput shall be equal to or larger than 70% of the maximum throughput for the FRCs stated in tables 8.1.2.1.2-1 to 8.1.2.1.2-14 at the given SNR for 1Tx or for 2Tx two-layer spatial multiplexing transmission. FRCs are defined in annex A.

**Table 8.1.2.1.2-1: Minimum requirements for PUSCH with 70% of maximum throughput, Type A, 5 MHz channel bandwidth, 15 kHz SCS**

Number of TX antennas	Number of Demodulation Branches	Propagation conditions and correlation matrix (Annex I)	FRC (Annex A)	Additional DM-RS position	SNR (dB)
1	2	TDLB100-400 Low	D-FR1-A.2.1-1	pos1	-2.3
		TDLC300-100 Low	D-FR1-A.2.3-1	pos1	10.1
		TDLA30-10 Low	D-FR1-A.2.4-1	pos1	12.3
	4	TDLB100-400 Low	D-FR1-A.2.1-1	pos1	-5.8
		TDLC300-100 Low	D-FR1-A.2.3-1	pos1	6.2
		TDLA30-10 Low	D-FR1-A.2.4-1	pos1	8.8
	8	TDLB100-400 Low	D-FR1-A.2.1-1	pos1	-8.7
		TDLC300-100 Low	D-FR1-A.2.3-1	pos1	3.0
		TDLA30-10 Low	D-FR1-A.2.4-1	pos1	5.6
2	2	TDLB100-400 Low	D-FR1-A.2.1-8	pos1	1.0
		TDLC300-100 Low	D-FR1-A.2.3-8	pos1	18.2
	4	TDLB100-400 Low	D-FR1-A.2.1-8	pos1	-2.3
		TDLC300-100 Low	D-FR1-A.2.3-8	pos1	11.0
	8	TDLB100-400 Low	D-FR1-A.2.1-8	pos1	-5.3
		TDLC300-100 Low	D-FR1-A.2.3-8	pos1	6.8

**Table 8.1.2.1.2-2: Minimum requirements for PUSCH with 70% of maximum throughput, Type A, 10 MHz channel bandwidth, 15 kHz SCS**

Number of TX antennas	Number of Demodulation Branches	Propagation conditions and correlation matrix (Annex I)	FRC (Annex A)	Additional DM-RS position	SNR (dB)
1	2	TDLB100-400 Low	D-FR1-A.2.1-2	pos1	-2.5
		TDLC300-100 Low	D-FR1-A.2.3-2	pos1	10.2
		TDLA30-10 Low	D-FR1-A.2.4-2	pos1	12.2
	4	TDLB100-400 Low	D-FR1-A.2.1-2	pos1	-6.0
		TDLC300-100 Low	D-FR1-A.2.3-2	pos1	6.3
		TDLA30-10 Low	D-FR1-A.2.4-2	pos1	8.6
	8	TDLB100-400 Low	D-FR1-A.2.1-2	pos1	-8.7
		TDLC300-100 Low	D-FR1-A.2.3-2	pos1	3.1
		TDLA30-10 Low	D-FR1-A.2.4-2	pos1	5.5
2	2	TDLB100-400 Low	D-FR1-A.2.1-9	pos1	1.7
		TDLC300-100 Low	D-FR1-A.2.3-9	pos1	18.3
	4	TDLB100-400 Low	D-FR1-A.2.1-9	pos1	-2.0
		TDLC300-100 Low	D-FR1-A.2.3-9	pos1	11.2
	8	TDLB100-400 Low	D-FR1-A.2.1-9	pos1	-5.5
		TDLC300-100 Low	D-FR1-A.2.3-9	pos1	6.8

**Table 8.1.2.1.2-3: Minimum requirements for PUSCH with 70% of maximum throughput, Type A, 20 MHz channel bandwidth, 15 kHz SCS**

Number of TX antennas	Number of Demodulation Branches	Propagation conditions and correlation matrix (Annex I)	FRC (Annex A)	Additional DM-RS position	SNR (dB)
1	2	TDLB100-400 Low	D-FR1-A.2.1-3	pos1	-2.1
		TDLC300-100 Low	D-FR1-A.2.3-3	pos1	10.0
		TDLA30-10 Low	D-FR1-A.2.4-3	pos1	12.4
	4	TDLB100-400 Low	D-FR1-A.2.1-3	pos1	-5.5
		TDLC300-100 Low	D-FR1-A.2.3-3	pos1	6.2
		TDLA30-10 Low	D-FR1-A.2.4-3	pos1	8.6
	8	TDLB100-400 Low	D-FR1-A.2.1-3	pos1	-8.5
		TDLC300-100 Low	D-FR1-A.2.3-3	pos1	3.0
		TDLA30-10 Low	D-FR1-A.2.4-3	pos1	5.5
2	2	TDLB100-400 Low	D-FR1-A.2.1-10	pos1	2.1
		TDLC300-100 Low	D-FR1-A.2.3-10	pos1	18.3
	4	TDLB100-400 Low	D-FR1-A.2.1-10	pos1	-1.8
		TDLC300-100 Low	D-FR1-A.2.3-10	pos1	11.1
	8	TDLB100-400 Low	D-FR1-A.2.1-10	pos1	-5.3
		TDLC300-100 Low	D-FR1-A.2.3-10	pos1	6.9

**Table 8.1.2.1.2-4: Minimum requirements for PUSCH with 70% of maximum throughput, Type A, 10 MHz channel bandwidth, 30 kHz SCS**

Number of TX antennas	Number of Demodulation Branches	Propagation conditions and correlation matrix (Annex I)	FRC (Annex A)	Additional DM-RS position	SNR (dB)
1	2	TDLB100-400 Low	D-FR1-A.2.1-4	pos1	-2.3
		TDLC300-100 Low	D-FR1-A.2.3-4	pos1	10.2
		TDLA30-10 Low	D-FR1-A.2.4-4	pos1	12.8
	4	TDLB100-400 Low	D-FR1-A.2.1-4	pos1	-5.6
		TDLC300-100 Low	D-FR1-A.2.3-4	pos1	6.4
		TDLA30-10 Low	D-FR1-A.2.4-4	pos1	8.6
	8	TDLB100-400 Low	D-FR1-A.2.1-4	pos1	-8.6
		TDLC300-100 Low	D-FR1-A.2.3-4	pos1	3.3
		TDLA30-10 Low	D-FR1-A.2.4-4	pos1	5.5
2	2	TDLB100-400 Low	D-FR1-A.2.1-11	pos1	1.3
		TDLC300-100 Low	D-FR1-A.2.3-11	pos1	18.4
	4	TDLB100-400 Low	D-FR1-A.2.1-11	pos1	-2.2
		TDLC300-100 Low	D-FR1-A.2.3-11	pos1	11.2
	8	TDLB100-400 Low	D-FR1-A.2.1-11	pos1	-5.2
		TDLC300-100 Low	D-FR1-A.2.3-11	pos1	7.0

**Table 8.1.2.1.2-5: Minimum requirements for PUSCH with 70% of maximum throughput, Type A, 20 MHz channel bandwidth, 30 kHz SCS**

Number of TX antennas	Number of Demodulation Branches	Propagation conditions and correlation matrix (Annex I)	FRC (Annex A)	Additional DM-RS position	SNR (dB)
1	2	TDLB100-400 Low	D-FR1-A.2.1-5	pos1	-2.9
		TDLC300-100 Low	D-FR1-A.2.3-5	pos1	10.2
		TDLA30-10 Low	D-FR1-A.2.4-5	pos1	12.5
	4	TDLB100-400 Low	D-FR1-A.2.1-5	pos1	-6.0
		TDLC300-100 Low	D-FR1-A.2.3-5	pos1	6.4
		TDLA30-10 Low	D-FR1-A.2.4-5	pos1	8.6
	8	TDLB100-400 Low	D-FR1-A.2.1-5	pos1	-8.8
		TDLC300-100 Low	D-FR1-A.2.3-5	pos1	3.2
		TDLA30-10 Low	D-FR1-A.2.4-5	pos1	5.5
2	2	TDLB100-400 Low	D-FR1-A.2.1-12	pos1	1.3
		TDLC300-100 Low	D-FR1-A.2.3-12	pos1	18.1
	4	TDLB100-400 Low	D-FR1-A.2.1-12	pos1	-2.2
		TDLC300-100 Low	D-FR1-A.2.3-12	pos1	11.3
	8	TDLB100-400 Low	D-FR1-A.2.1-12	pos1	-5.3
		TDLC300-100 Low	D-FR1-A.2.3-12	pos1	6.9

**Table 8.1.2.1.2-6: Minimum requirements for PUSCH with 70% of maximum throughput, Type A, 40 MHz channel bandwidth, 30 kHz SCS**

Number of TX antennas	Number of Demodulation Branches	Propagation conditions and correlation matrix (Annex I)	FRC (Annex A)	Additional DM-RS position	SNR (dB)
1	2	TDLB100-400 Low	D-FR1-A.2.1-6	pos1	-2.5
		TDLC300-100 Low	D-FR1-A.2.3-6	pos1	10.0
		TDLA30-10 Low	D-FR1-A.2.4-6	pos1	12.4
	4	TDLB100-400 Low	D-FR1-A.2.1-6	pos1	-5.8
		TDLC300-100 Low	D-FR1-A.2.3-6	pos1	6.3
		TDLA30-10 Low	D-FR1-A.2.4-6	pos1	8.5
	8	TDLB100-400 Low	D-FR1-A.2.1-6	pos1	-8.7
		TDLC300-100 Low	D-FR1-A.2.3-6	pos1	3.1
		TDLA30-10 Low	D-FR1-A.2.4-6	pos1	5.4
2	2	TDLB100-400 Low	D-FR1-A.2.1-13	pos1	1.3
		TDLC300-100 Low	D-FR1-A.2.3-13	pos1	19.5
	4	TDLB100-400 Low	D-FR1-A.2.1-13	pos1	-2.3
		TDLC300-100 Low	D-FR1-A.2.3-13	pos1	11.3
	8	TDLB100-400 Low	D-FR1-A.2.1-13	pos1	-5.2
		TDLC300-100 Low	D-FR1-A.2.3-13	pos1	6.9

**Table 8.1.2.1.2-7: Minimum requirements for PUSCH with 70% of maximum throughput, Type A, 100 MHz channel bandwidth, 30 kHz SCS**

Number of TX antennas	Number of Demodulation Branches	Propagation conditions and correlation matrix (Annex I)	FRC (Annex A)	Additional DM-RS position	SNR (dB)
1	2	TDLB100-400 Low	D-FR1-A.2.1-7	pos1	-2.8
		TDLC300-100 Low	D-FR1-A.2.3-7	pos1	10.2
		TDLA30-10 Low	D-FR1-A.2.4-7	pos1	13.0
	4	TDLB100-400 Low	D-FR1-A.2.1-7	pos1	-5.8
		TDLC300-100 Low	D-FR1-A.2.3-7	pos1	6.5
		TDLA30-10 Low	D-FR1-A.2.4-7	pos1	9.0
	8	TDLB100-400 Low	D-FR1-A.2.1-7	pos1	-8.7
		TDLC300-100 Low	D-FR1-A.2.3-7	pos1	3.2
		TDLA30-10 Low	D-FR1-A.2.4-7	pos1	5.8
2	2	TDLB100-400 Low	D-FR1-A.2.1-14	pos1	1.4
		TDLC300-100 Low	D-FR1-A.2.3-14	pos1	19.2
	4	TDLB100-400 Low	D-FR1-A.2.1-14	pos1	-2.2
		TDLC300-100 Low	D-FR1-A.2.3-14	pos1	11.6
	8	TDLB100-400 Low	D-FR1-A.2.1-14	pos1	-5.2
		TDLC300-100 Low	D-FR1-A.2.3-14	pos1	7.1

**Table 8.1.2.1.2-8: Minimum requirements for PUSCH with 70% of maximum throughput, Type B, 5 MHz channel bandwidth, 15 kHz SCS**

Number of TX antennas	Number of Demodulation Branches	Propagation conditions and correlation matrix (Annex I)	FRC (Annex A)	Additional DM-RS position	SNR (dB)
1	2	TDLB100-400 Low	D-FR1-A.2.1-1	pos1	-2.3
		TDLC300-100 Low	D-FR1-A.2.3-1	pos1	10.2
		TDLA30-10 Low	D-FR1-A.2.4-1	pos1	12.5
	4	TDLB100-400 Low	D-FR1-A.2.1-1	pos1	-5.7
		TDLC300-100 Low	D-FR1-A.2.3-1	pos1	6.3
		TDLA30-10 Low	D-FR1-A.2.4-1	pos1	8.9
	8	TDLB100-400 Low	D-FR1-A.2.1-1	pos1	-8.7
		TDLC300-100 Low	D-FR1-A.2.3-1	pos1	3.0
		TDLA30-10 Low	D-FR1-A.2.4-1	pos1	5.7
2	2	TDLB100-400 Low	D-FR1-A.2.1-8	pos1	1.5
		TDLC300-100 Low	D-FR1-A.2.3-8	pos1	18.3
	4	TDLB100-400 Low	D-FR1-A.2.1-8	pos1	-2.3
		TDLC300-100 Low	D-FR1-A.2.3-8	pos1	11.1
	8	TDLB100-400 Low	D-FR1-A.2.1-8	pos1	-5.4
		TDLC300-100 Low	D-FR1-A.2.3-8	pos1	6.8

**Table 8.1.2.1.2-9: Minimum requirements for PUSCH with 70% of maximum throughput, Type B, 10 MHz channel bandwidth, 15 kHz SCS**

Number of TX antennas	Number of Demodulation Branches	Propagation conditions and correlation matrix (Annex I)	FRC (Annex A)	Additional DM-RS position	SNR (dB)
1	2	TDLB100-400 Low	D-FR1-A.2.1-2	pos1	-2.3
		TDLC300-100 Low	D-FR1-A.2.3-2	pos1	10.5
		TDLA30-10 Low	D-FR1-A.2.4-2	pos1	12.6
	4	TDLB100-400 Low	D-FR1-A.2.1-2	pos1	-5.7
		TDLC300-100 Low	D-FR1-A.2.3-2	pos1	6.5
		TDLA30-10 Low	D-FR1-A.2.4-2	pos1	8.9
	8	TDLB100-400 Low	D-FR1-A.2.1-2	pos1	-9.0
		TDLC300-100 Low	D-FR1-A.2.3-2	pos1	3.2
		TDLA30-10 Low	D-FR1-A.2.4-2	pos1	5.8
2	2	TDLB100-400 Low	D-FR1-A.2.1-9	pos1	2.0
		TDLC300-100 Low	D-FR1-A.2.3-9	pos1	18.7
	4	TDLB100-400 Low	D-FR1-A.2.1-9	pos1	-2.3
		TDLC300-100 Low	D-FR1-A.2.3-9	pos1	11.3
	8	TDLB100-400 Low	D-FR1-A.2.1-9	pos1	-5.2
		TDLC300-100 Low	D-FR1-A.2.3-9	pos1	7.0

**Table 8.1.2.1.2-10: Minimum requirements for PUSCH with 70% of maximum throughput, Type B, 20 MHz channel bandwidth, 15 kHz SCS**

Number of TX antennas	Number of Demodulation Branches	Propagation conditions and correlation matrix (Annex I)	FRC (Annex A)	Additional DM-RS position	SNR (dB)
1	2	TDLB100-400 Low	D-FR1-A.2.1-3	pos1	-2.1
		TDLC300-100 Low	D-FR1-A.2.3-3	pos1	10.4
		TDLA30-10 Low	D-FR1-A.2.4-3	pos1	12.3
	4	TDLB100-400 Low	D-FR1-A.2.1-3	pos1	-5.7
		TDLC300-100 Low	D-FR1-A.2.3-3	pos1	6.3
		TDLA30-10 Low	D-FR1-A.2.4-3	pos1	8.8
	8	TDLB100-400 Low	D-FR1-A.2.1-3	pos1	-8.5
		TDLC300-100 Low	D-FR1-A.2.3-3	pos1	3.1
		TDLA30-10 Low	D-FR1-A.2.4-3	pos1	5.7
2	2	TDLB100-400 Low	D-FR1-A.2.1-10	pos1	1.6
		TDLC300-100 Low	D-FR1-A.2.3-10	pos1	18.1
	4	TDLB100-400 Low	D-FR1-A.2.1-10	pos1	-2.0
		TDLC300-100 Low	D-FR1-A.2.3-10	pos1	11.2
	8	TDLB100-400 Low	D-FR1-A.2.1-10	pos1	-5.3
		TDLC300-100 Low	D-FR1-A.2.3-10	pos1	6.9

**Table 8.1.2.1.2-11: Minimum requirements for PUSCH with 70% of maximum throughput, Type B, 10 MHz channel bandwidth, 30 kHz SCS**

Number of TX antennas	Number of Demodulation Branches	Propagation conditions and correlation matrix (Annex I)	FRC (Annex A)	Additional DM-RS position	SNR (dB)
1	2	TDLB100-400 Low	D-FR1-A.2.1-4	pos1	-2.4
		TDLC300-100 Low	D-FR1-A.2.3-4	pos1	10.1
		TDLA30-10 Low	D-FR1-A.2.4-4	pos1	12.5
	4	TDLB100-400 Low	D-FR1-A.2.1-4	pos1	-5.7
		TDLC300-100 Low	D-FR1-A.2.3-4	pos1	6.4
		TDLA30-10 Low	D-FR1-A.2.4-4	pos1	8.6
	8	TDLB100-400 Low	D-FR1-A.2.1-4	pos1	-8.8
		TDLC300-100 Low	D-FR1-A.2.3-4	pos1	3.2
		TDLA30-10 Low	D-FR1-A.2.4-4	pos1	5.6
2	2	TDLB100-400 Low	D-FR1-A.2.1-11	pos1	1.1
		TDLC300-100 Low	D-FR1-A.2.3-11	pos1	18.5
	4	TDLB100-400 Low	D-FR1-A.2.1-11	pos1	-2.5
		TDLC300-100 Low	D-FR1-A.2.3-11	pos1	11.3
	8	TDLB100-400 Low	D-FR1-A.2.1-11	pos1	-5.6
		TDLC300-100 Low	D-FR1-A.2.3-11	pos1	7.0

**Table 8.1.2.1.2-12: Minimum requirements for PUSCH with 70% of maximum throughput, Type B, 20 MHz channel bandwidth, 30 kHz SCS**

Number of TX antennas	Number of Demodulation Branches	Propagation conditions and correlation matrix (Annex I)	FRC (Annex A)	Additional DM-RS position	SNR (dB)
1	2	TDLB100-400 Low	D-FR1-A.2.1-5	pos1	-2.9
		TDLC300-100 Low	D-FR1-A.2.3-5	pos1	10.1
		TDLA30-10 Low	D-FR1-A.2.4-5	pos1	12.5
	4	TDLB100-400 Low	D-FR1-A.2.1-5	pos1	-6.0
		TDLC300-100 Low	D-FR1-A.2.3-5	pos1	6.3
		TDLA30-10 Low	D-FR1-A.2.4-5	pos1	8.6
	8	TDLB100-400 Low	D-FR1-A.2.1-5	pos1	-9.0
		TDLC300-100 Low	D-FR1-A.2.3-5	pos1	3.1
		TDLA30-10 Low	D-FR1-A.2.4-5	pos1	5.6
2	2	TDLB100-400 Low	D-FR1-A.2.1-12	pos1	1.3
		TDLC300-100 Low	D-FR1-A.2.3-12	pos1	18.2
	4	TDLB100-400 Low	D-FR1-A.2.1-12	pos1	-2.3
		TDLC300-100 Low	D-FR1-A.2.3-12	pos1	11.2
	8	TDLB100-400 Low	D-FR1-A.2.1-12	pos1	-5.4
		TDLC300-100 Low	D-FR1-A.2.3-12	pos1	7.0



**Table 8.1.2.1.2-13: Minimum requirements for PUSCH with 70% of maximum throughput, Type B, 40 MHz channel bandwidth, 30 kHz SCS**

Number of TX antennas	Number of Demodulation Branches	Propagation conditions and correlation matrix (Annex I)	FRC (Annex A)	Additional DM-RS position	SNR (dB)
1	2	TDLB100-400 Low	D-FR1-A.2.1-6	pos1	-2.5
		TDLC300-100 Low	D-FR1-A.2.3-6	pos1	10.0
		TDLA30-10 Low	D-FR1-A.2.4-6	pos1	12.5
	4	TDLB100-400 Low	D-FR1-A.2.1-6	pos1	-5.8
		TDLC300-100 Low	D-FR1-A.2.3-6	pos1	6.2
		TDLA30-10 Low	D-FR1-A.2.4-6	pos1	8.7
	8	TDLB100-400 Low	D-FR1-A.2.1-6	pos1	-8.8
		TDLC300-100 Low	D-FR1-A.2.3-6	pos1	3.0
		TDLA30-10 Low	D-FR1-A.2.4-6	pos1	5.5
2	2	TDLB100-400 Low	D-FR1-A.2.1-13	pos1	1.7
		TDLC300-100 Low	D-FR1-A.2.3-13	pos1	18.7
	4	TDLB100-400 Low	D-FR1-A.2.1-13	pos1	-2.1
		TDLC300-100 Low	D-FR1-A.2.3-13	pos1	11.2
	8	TDLB100-400 Low	D-FR1-A.2.1-13	pos1	-5.2
		TDLC300-100 Low	D-FR1-A.2.3-13	pos1	6.9

**Table 8.1.2.1.2-14: Minimum requirements for PUSCH with 70% of maximum throughput, Type B, 100 MHz channel bandwidth, 30 kHz SCS**

Number of TX antennas	Number of Demodulation Branches	Propagation conditions and correlation matrix (Annex I)	FRC (Annex A)	Additional DM-RS position	SNR (dB)
1	2	TDLB100-400 Low	D-FR1-A.2.1-7	pos1	-2.5
		TDLC300-100 Low	D-FR1-A.2.3-7	pos1	10.1
		TDLA30-10 Low	D-FR1-A.2.4-7	pos1	13.1
	4	TDLB100-400 Low	D-FR1-A.2.1-7	pos1	-5.8
		TDLC300-100 Low	D-FR1-A.2.3-7	pos1	6.3
		TDLA30-10 Low	D-FR1-A.2.4-7	pos1	9.2
	8	TDLB100-400 Low	D-FR1-A.2.1-7	pos1	-8.7
		TDLC300-100 Low	D-FR1-A.2.3-7	pos1	3.1
		TDLA30-10 Low	D-FR1-A.2.4-7	pos1	5.9
2	2	TDLB100-400 Low	D-FR1-A.2.1-14	pos1	1.6
		TDLC300-100 Low	D-FR1-A.2.3-14	pos1	19.3
	4	TDLB100-400 Low	D-FR1-A.2.1-14	pos1	-2.2
		TDLC300-100 Low	D-FR1-A.2.3-14	pos1	11.6
	8	TDLB100-400 Low	D-FR1-A.2.1-14	pos1	-5.3
		TDLC300-100 Low	D-FR1-A.2.3-14	pos1	7.1

## 8.1.2.2 Requirements for PUSCH with transform precoding enabled

### 8.1.2.2.1 General

The performance requirement of PUSCH is determined by a minimum required throughput for a given SNR. The required throughput is expressed as a fraction of maximum throughput for the FRCs listed in annex A. The performance requirements assume HARQ retransmissions.

Table 8.1.2.2.1-1: Test parameters for testing PUSCH

Parameter		Value
Transform precoding		Enabled
Cyclic Prefix		Normal
Default TDD UL-DL pattern (Note 1)		15 kHz SCS: 3D1S1U, S=10D:2G:2U 30 kHz SCS: 7D1S2U, S=6D:4G:4U
HARQ	Maximum number of HARQ transmissions	4
	RV sequence	0, 2, 3, 1
DM-RS	DM-RS configuration type	1
	DM-RS duration	single-symbol DM-RS
	Additional DM-RS position	pos1
	Number of DM-RS CDM group(s) without data	2
	Ratio of PUSCH EPRE to DM-RS EPRE	-3 dB
	DM-RS port(s)	0
DM-RS sequence generation		$N_{ID}^0=0$ , group hopping and sequence hopping are disabled
Time domain resource assignment	PUSCH mapping type	A, B
	Start symbol	0
	Allocation length	14
Frequency domain resource assignment	RB assignment	15 kHz SCS: 25 PRBs in the middle of the test bandwidth 30 kHz SCS: 24 PRBs in the middle of the test bandwidth
	Frequency hopping	Disabled
Code block group based PUSCH transmission		Disabled
NOTE 1: The same requirements are applicable to different UL-DL patterns.		

### 8.1.2.2.2 Minimum requirements

The throughput shall be equal to or larger than 70% of the maximum throughput for the FRCs stated in tables 8.1.2.2.2-1 to 8.1.2.2.2-4 at the given SNR. FRCs are defined in annex A.

**Table 8.1.2.2.2-1: Minimum requirements for PUSCH with 70% of maximum throughput, Type A, 5 MHz channel bandwidth, 15 kHz SCS**

Number of TX antennas	Number of Demodulation Branches	Propagation conditions and correlation matrix (Annex I)	FRC (Annex A)	Additional DM-RS position	SNR (dB)
1	2	TDLB100-400 Low	D-FR1-A.2.1-15	pos1	-2.4
	4	TDLB100-400 Low	D-FR1-A.2.1-15	pos1	-5.7
	8	TDLB100-400 Low	D-FR1-A.2.1-15	pos1	-8.5

**Table 8.1.2.2.2-2: Minimum requirements for PUSCH with 70% of maximum throughput, Type A, 10 MHz channel bandwidth, 30 kHz SCS**

Number of TX antennas	Number of Demodulation Branches	Propagation conditions and correlation matrix (Annex I)	FRC (Annex A)	Additional DM-RS position	SNR (dB)
1	2	TDLB100-400 Low	D-FR1-A.2.1-16	pos1	-2.5
	4	TDLB100-400 Low	D-FR1-A.2.1-16	pos1	-5.7
	8	TDLB100-400 Low	D-FR1-A.2.1-16	pos1	-8.4

**Table 8.1.2.2.2-3: Minimum requirements for PUSCH with 70% of maximum throughput, Type B, 5 MHz channel bandwidth, 15 kHz SCS**

Number of TX antennas	Number of Demodulation Branches	Propagation conditions and correlation matrix (Annex I)	FRC (Annex A)	Additional DM-RS position	SNR (dB)
1	2	TDLB100-400 Low	D-FR1-A.2.1-15	pos1	-2.3
	4	TDLB100-400 Low	D-FR1-A.2.1-15	pos1	-5.8
	8	TDLB100-400 Low	D-FR1-A.2.1-15	pos1	-8.6

**Table 8.1.2.2.2-4: Minimum requirements for PUSCH with 70% of maximum throughput, Type B, 10 MHz channel bandwidth, 30 kHz SCS**

Number of TX antennas	Number of Demodulation Branches	Propagation conditions and correlation matrix (Annex I)	FRC (Annex A)	Additional DM-RS position	SNR (dB)
1	2	TDLB100-400 Low	D-FR1-A.2.1-16	pos1	-2.7
	4	TDLB100-400 Low	D-FR1-A.2.1-16	pos1	-6.0
	8	TDLB100-400 Low	D-FR1-A.2.1-16	pos1	-8.8

### 8.1.2.3 Requirements for UCI multiplexed on PUSCH

#### 8.1.2.3.1 General

In the tests for UCI multiplexed on PUSCH, the UCI information only contains CSI part 1 and CSI part 2 information, and there is no HACK/ACK information transmitted.

The CSI part 1 block error probability (BLER) is defined as the probability of incorrectly decoding the CSI part 1 information when the CSI part 1 information is sent as follow:

$$BLER_{CSI\ part\ 1} = \frac{\#(\text{false CSI part 1})}{\#(\text{CSI part 1})}$$

where:

- #(false CSI part 1) denotes the number of incorrectly decoded CSI part 1 information transmitted occasions
- #(CSI part 1) denotes the number of CSI part 1 information transmitted occasions.

The CSI part 2 block error probability is defined as the probability of incorrectly decoding the CSI part 2 information when the CSI part 2 information is sent as follows:

$$BLER_{CSI\ part\ 2} = \frac{\#(\text{false CSI part 2})}{\#(\text{CSI part 2})}$$

where:

- #(false CSI part 2) denotes the number of incorrectly decoded CSI part 2 information transmitted occasions
- #(CSI part 2) denotes the number of CSI part 2 information transmitted occasions.

The number of UCI information bit payload per slot is defined for two cases as follows:

- 5 bits in CSI part 1, 2 bits in CSI part 2
- 20 bits in CSI part 1, 20 bits in CSI part 2

The 7bits UCI case is further defined with the bitmap [c0 c1 c2 c3 c4] = [0 1 0 1 0] for CSI part 1 information, where c0 is mapping to the RI information, and with the bitmap [c0 c1] = [1 0] for CSI part2 information.

The 40bits UCI information case is assumed random information bit selection.

In both tests, PUSCH data, CSI part 1 and CSI part 2 information are transmitted simultaneously.

**Table 8.1.2.3.1-1: Test parameters for testing UCI on PUSCH**

Parameter		Value
Transform precoding		Disabled
Default TDD UL-DL pattern (Note 1)		30 kHz SCS: 7D1S2U, S=6D:4G:4U
Cyclic Prefix		Normal
HARQ	Maximum number of HARQ transmissions	1
	RV sequence	0
DM-RS	DM-RS configuration type	1
	DM-RS duration	Single-symbol DM-RS
	Additional DM-RS position	pos1
	Number of DM-RS CDM group(s) without data	2
	Ratio of PUSCH EPRE to DM-RS EPRE	-3 dB
	DM-RS port(s)	{0}
DM-RS sequence generation		$N_{ID}^0=0, n_{SCID}=0$
Time domain resource assignment	PUSCH mapping type	A,B
	Start symbol	0
	Allocation length	14
Frequency domain resource assignment	RB assignment	Full applicable test bandwidth
	Frequency hopping	Disabled
Code block group based PUSCH transmission		Disabled
UCI	Number of CSI part 1 and CSI part 2 information bit payload	{5,2},{20,20}
	scaling	1
	betaOffsetACK-Index1	11
	betaOffsetCSI-Part1-Index1 and betaOffsetCSI-Part1-Index2	13
	betaOffsetCSI-Part2-Index1 and betaOffsetCSI-Part2-Index2	13
	UCI partition for frequency hopping	Disabled
NOTE 1: The same requirements are applicable to different UL-DL patterns.		

### 8.1.2.3.2 Minimum requirements

The CSI part 1 block error probability shall not exceed 0.1% at the SNR in table 8.1.2.3.2-1 and table 8.1.2.3.2-2. The CSI part 2 block error probability shall not exceed 1% at the SNR given in table 8.1.2.3.2-3 and table 8.1.2.3.2-4.

**Table 8.1.2.3.2-1: Minimum requirements for UCI multiplexed on PUSCH, Type A, CSI part 1, 10 MHz Channel Bandwidth, 30 kHz SCS**

Number of TX antennas	Number of Demodulation Branches	Propagation conditions and correlation matrix (Annex I)	UCI bits (CSI part 1, CSI part 2)	Additional DM-RS position	FRC (Annex A)	SNR (dB)
1	2	TDLC300-100 Low	7(5,2)	pos1	D-FR1-A.2.3-4	5.4
	2	TDLC300-100 Low	40(20,20)	pos1	D-FR1-A.2.3-4	4.3

**Table 8.1.2.3.2-2: Minimum requirements for UCI multiplexed on PUSCH, Type B, CSI part 1, 10 MHz Channel Bandwidth, 30 kHz SCS**

Number of TX antennas	Number of Demodulation Branches	Propagation conditions and correlation matrix (Annex I)	UCI bits (CSI part 1, CSI part 2)	Additional DM-RS position	FRC (Annex A)	SNR (dB)
1	2	TDLC300-100 Low	7(5,2)	pos1	D-FR1-A.2.3-4	5.8
	2	TDLC300-100 Low	40(20,20)	pos1	D-FR1-A.2.3-4	4.1

**Table 8.1.2.3.2-3: Minimum requirements for UCI multiplexed on PUSCH, Type A, CSI part 2, 10 MHz Channel Bandwidth, 30 kHz SCS**

Number of TX antennas	Number of Demodulation Branches	Propagation conditions and correlation matrix (Annex I)	UCI bits (CSI part 1, CSI part 2)	Additional DM-RS position	FRC (Annex A)	SNR (dB)
1	2	TDLC300-100 Low	7(5,2)	pos1	D-FR1-A.2.3-4	-0.2
	2	TDLC300-100 Low	40(20,20)	pos1	D-FR1-A.2.3-4	2.4

**Table 8.1.2.3.2-4: Minimum requirements for UCI multiplexed on PUSCH, Type B, CSI part 2, 10 MHz Channel Bandwidth, 30 kHz SCS**

Number of TX antennas	Number of Demodulation Branches	Propagation conditions and correlation matrix (Annex I)	UCI bits (CSI part 1, CSI part 2)	Additional DM-RS position	FRC (Annex A)	SNR (dB)
1	2	TDLC300-100 Low	7(5,2)	pos1	D-FR1-A.2.3-4	0.3
	2	TDLC300-100 Low	40(20,20)	pos1	D-FR1-A.2.3-4	2.6

## 8.1.3 Performance requirements for PUCCH

### 8.1.3.1 DTX to ACK probability

#### 8.1.3.1.1 General

The DTX to ACK probability, i.e. the probability that ACK is detected when nothing was sent:

$$\text{Prob}(\text{PUCCH DTX} \rightarrow \text{Ack bits}) = \frac{\#(\text{false ACK bits})}{\#(\text{PUCCH DTX}) * \#(\text{ACK/NACK bits})}$$

where:

- #(false ACK bits) denotes the number of detected ACK bits.
- #(ACK/NACK bits) denotes the number of encoded bits per slot

- #(PUCCH DTX) denotes the number of DTX occasions

### 8.1.3.1.2 Minimum requirement

The DTX to ACK probability shall not exceed 1% for all PUCCH formats carrying ACK/NACK bits:

$$\text{Prob}(\text{PUCCH DTX} \rightarrow \text{Ack bits}) \leq 10^{-2}$$

### 8.1.3.2 Performance requirements for PUCCH format 0

#### 8.1.3.2.1 General

The ACK missed detection probability is the probability of not detecting an ACK when an ACK was sent.

**Table 8.1.3.2.1-1: Test Parameters**

Parameter	Test
Number of UCI information bits	1
Number of PRBs	1
First PRB prior to frequency hopping	0
Intra-slot frequency hopping	N/A for 1 symbol Enabled for 2 symbols
First PRB after frequency hopping	The largest PRB index – (Number of PRBs – 1)
Group and sequence hopping	neither
Hopping ID	0
Initial cyclic shift	0
First symbol	13 for 1 symbol 12 for 2 symbols

[The transient period as specified in TS 38.101-1 [3] clause 6.3.3.1 is not taken into account for performance requirement testing, where the RB hopping is symmetric to the CC centre, i.e. intra-slot frequency hopping is enabled.]

#### 8.1.3.2.2 Minimum requirement

The ACK missed detection probability shall not exceed 1% at the SNR given in table 8.1.3.2.2-1 and in table 8.1.3.2.2-2.

**Table 8.1.3.2.2-1: Minimum requirements for PUCCH format 0 and 15 kHz SCS**

Number of TX antennas	Number of RX antennas	Propagation conditions and correlation matrix (Annex I)	Number of OFDM symbols	Channel bandwidth / SNR (dB)		
				5 MHz	10 MHz	20 MHz
1	2	TDLC300-100 Low	1	9.4	8.8	9.3
			2	2.8	3.7	3.3
1	4	TDLC300-100 Low	1	3.0	2.9	3.2
			2	-1.0	-0.5	-0.8
1	8	TDLC300-100 Low	1	-1.1	-1.1	-1.1
			2	-4.1	-3.9	-4.0

**Table 8.1.3.2-2: Minimum requirements for PUCCH format 0 and 30 kHz SCS**

Number of TX antennas	Number of RX antennas	Propagation conditions and correlation matrix (Annex I)	Number of OFDM symbols	Channel bandwidth / SNR (dB)			
				10 MHz	20 MHz	40 MHz	100 MHz
1	2	TDLC300-100 Low	1	9.8	9.8	9.5	9.2
			2	4.2	3.6	3.8	3.5
1	4	TDLC300-100 Low	1	3.4	3.4	3.0	3.3
			2	-0.3	-0.4	-0.5	-0.8
1	8	TDLC300-100 Low	1	-1.0	-1.0	-1.1	-1.0
			2	-3.7	-3.8	-4.0	-3.9

### 8.1.3.3 Performance requirements for PUCCH format 1

#### 8.1.3.3.1 NACK to ACK requirements

##### 8.1.3.3.1.1 General

The NACK to ACK detection probability is the probability that an ACK bit is falsely detected when a NACK bit was sent on the particular bit position, where the NACK to ACK detection probability is defined as follows:

$$\text{Prob}(\text{PUCCH NACK} \rightarrow \text{ACK bits}) = \frac{\#(\text{NACK bits decoded as ACK bits})}{\#(\text{Total NACK bits})},$$

where:

- $\#(\text{Total NACK bits})$  denotes the total number of NACK bits transmitted
- $\#(\text{NACK bits decoded as ACK bits})$  denotes the number of NACK bits decoded as ACK bits at the receiver, i.e. the number of received ACK bits
- NACK bits in the definition do not contain the NACK bits which are mapped from DTX, i.e. NACK bits received when DTX is sent should not be considered.

Random codeword selection is assumed.

**Table 8.1.3.3.1.1-1: Test Parameters**

Parameter	Test
Cyclic prefix	Normal
Number of information bits	2
Number of PRBs	1
Number of symbols	14
First PRB prior to frequency hopping	0
Intra-slot frequency hopping	enabled
First PRB after frequency hopping	The largest PRB index – (nrofPRBs – 1)
Group and sequence hopping	neither
Hopping ID	0
Initial cyclic shift	0
First symbol	0
Index of orthogonal cover code ( <i>timeDomainOCC</i> )	0

[The transient period as specified in TS 38.101-1 [3] clause 6.3.3.1 is not taken into account for performance requirement testing, where the RB hopping is symmetric to the CC centre, i.e. intra-slot frequency hopping is enabled.]

## 8.1.3.3.1.2 Minimum requirements

The NACK to ACK probability shall not exceed 0.1% at the SNR given in table 8.1.3.3.1.2-1 and table 8.1.3.3.1.2-2.

**Table 8.1.3.3.1.2-1: Minimum requirements for PUCCH format 1 with 15 kHz SCS**

Number of TX antennas	Number of Demodulation Branches	Propagation conditions and correlation matrix (Annex I)	Channel bandwidth / SNR (dB)		
			5 MHz	10 MHz	20 MHz
1	2	TDLC-300-100 Low	-3.8	-3.6	-3.6
	4	TDLC-300-100 Low	-8.4	-7.6	-8.4
	8	TDLC-300-100 Low	-11.8	-11.4	-11.4

**Table 8.1.3.3.1.2-2: Minimum requirements for PUCCH format 1 with 30 kHz SCS**

Number of TX antennas	Number of Demodulation Branches	Propagation conditions and correlation matrix (Annex I)	Channel bandwidth / SNR (dB)			
			10 MHz	20 MHz	40 MHz	100 MHz
1	2	TDLC-300-100 Low	-2.8	-3.3	-3.9	-3.5
	4	TDLC-300-100 Low	-8.1	-8.3	-7.5	-8.0
	8	TDLC-300-100 Low	-11.5	-11.2	-11.6	-11.3

## 8.1.3.3.2 ACK missed detection requirements

## 8.1.3.3.2.1 General

The ACK missed detection probability is the probability of not detecting an ACK when an ACK was sent. The test parameters in table 8.3.3.1.1-1 are configured.

[The transient period as specified in TS 38.101-1 [3] clause 6.3.3.1 is not taken into account for performance requirement testing, where the RB hopping is symmetric to the centre, i.e. intra-slot frequency hopping is enabled.]

## 8.1.3.3.2.2 Minimum requirements

The ACK missed detection probability shall not exceed 1% at the SNR given in table 8.1.3.3.2.2-1 and in table 8.1.3.3.2.2-2.



**Table 8.1.3.3.2-1: Minimum requirements for PUCCH format 1 with 15 kHz SCS**

Number of TX antennas	Number of Demodulation Branches	Propagation conditions and correlation matrix (Annex I)	Channel bandwidth / SNR (dB)		
			5 MHz	10 MHz	20 MHz
1	2	TDLC-300-100 Low	-5.0	-4.4	-5.0
	4	TDLC-300-100 Low	-8.6	-8.2	-8.5
	8	TDLC-300-100 Low	-11.6	-11.5	-11.5

**Table 8.1.3.3.2-2: Minimum requirements for PUCCH format 1 with 30 kHz SCS**

Number of TX antennas	Number of Demodulation Branches	Propagation conditions and correlation matrix (Annex I)	Channel bandwidth / SNR (dB)			
			10 MHz	20 MHz	40 MHz	100 MHz
1	2	TDLC-300-100 Low	-3.9	-4.4	-4.4	-4.2
	4	TDLC-300-100 Low	-8.0	-8.1	-8.4	-8.3
	8	TDLC-300-100 Low	-11.4	-11.4	-11.4	-11.4

### 8.1.3.4 Performance requirements for PUCCH format 2

#### 8.1.3.4.1 NACK to ACK requirements

##### 8.1.3.4.1.1 General

The ACK missed detection probability is the probability of not detecting an ACK when an ACK was sent.

The ACK missed detection requirement only applies to the PUCCH format 2 with 4 UCI bits.

**Table 8.1.3.4.1.1-1: Test Parameters**

Parameter	Value
Cyclic Prefix	Normal
Modulation order	QSPK
First PRB prior to frequency hopping	0
Intra-slot frequency hopping	N/A
First PRB after frequency hopping	The largest PRB index – (Number of PRBs – 1)
Number of PRBs	4
Number of symbols	1
The number of UCI information bits	4
First symbol	13
DM-RS sequence generation	$N_{ID}^0=0$

[The transient period as specified in TS 38.101-1 [3] clause 6.3.3.1 is not taken into account for performance requirement testing, where the RB hopping is symmetric to the CC center, i.e. intra-slot frequency hopping is enabled.]

## 8.1.3.4.1.2 Minimum requirements

The ACK missed detection probability shall not exceed 1% at the SNR given in table 8.1.3.4.1.2-1 and table 8.1.3.4.1.2-2 for 4UCI bits.

**Table 8.1.3.4.1.2-1: Minimum requirements for PUCCH format 2 with 15 kHz SCS**

Number of TX antennas	Number of Demodulation Branches	Propagation conditions and correlation matrix (Annex I)	Channel bandwidth / SNR (dB)		
			5 MHz	10 MHz	20 MHz
1	2	TDLC300-100 Low	5.8	5.6	5.9
	4	TDLC300-100 Low	0.4	0.5	0.3
	8	TDLC300-100 Low	-3.5	-3.5	-3.5

**Table 8.1.3.4.1.2-2: Minimum requirements for PUCCH format 2 with 30 kHz SCS**

Number of TX antennas	Number of Demodulation Branches	Propagation conditions and correlation matrix (Annex I)	Channel bandwidth / SNR (dB)			
			10 MHz	20 MHz	40 MHz	100 MHz
1	2	TDLC300-100 Low	5.5	5.6	5.5	5.7
	4	TDLC300-100 Low	0.3	0.2	0.3	0.4
	8	TDLC300-100 Low	-3.6	-3.6	-3.5	-3.3

## 8.1.3.4.2 UCI BLER performance requirements

## 8.1.3.4.2.1 General

The UCI block error probability (BLER) is defined as the probability of incorrectly decoding the UCI information when the UCI information is sent. The UCI information does not contain CSI part 2.

[The transient period as specified in TS 38.101-1 [3] clause 6.3.3.1 is not taken into account for performance requirement testing, where the RB hopping is symmetric to the CC centre, i.e. intra-slot frequency hopping is enabled.]

The UCI block error probability performance requirement only applies to the PUCCH format 2 with 22 UCI bits.

**Table 8.1.3.4.2.1-1: Test Parameters**

Parameter	Value
Cyclic Prefix	Normal
Modulation order	QSPK
First PRB prior to frequency hopping	0
Intra-slot frequency hopping	enabled
Frist PRB after frequency hopping	The largest PRB index – (Number of PRBs – 1)
Number of PRBs	9
Number of symbols	2
The number of UCI information bits	22
First symbol	12
DM-RS sequence generation	$N_D^0=0$

## 8.1.3.4.2.2 Minimum requirement

The UCI block error probability shall not exceed 1% at the SNR given in table 8.2.3.4.2.2-1 and table 8.1.3.4.2.2-2 for 22 UCI bits.

**Table 8.1.3.4.2.2-1: Minimum requirements for PUCCH format 2 with 15 kHz SCS**

Number of TX antennas	Number of Demodulation Branches	Channel bandwidth / SNR (dB)		
		5 MHz	10 MHz	20 MHz
1	2	0.2	0.8	1.2
	4	-3.6	-3.2	-3.2
	8	-6.8	-6.7	-6.8

**Table 8.1.3.4.2.2-2: Minimum requirements for PUCCH format 2 with 30 kHz SCS**

Number of TX antennas	Number of Demodulation Branches	Cyclic Prefix	Propagation conditions and correlation matrix (Annex I)	Channel bandwidth / SNR (dB)			
				10 MHz	20 MHz	40 MHz	100 MHz
1	2	Normal	TDLC300-100 Low	0.5	1.1	0.4	0.3
	4	Normal	TDLC300-100 Low	-3.3	-2.9	-3.3	-3.4
	8	Normal	TDLC300-100 Low	-5.8	-5.8	-6.7	-5.9

## 8.1.3.5 Performance requirements for PUCCH format 3

## 8.1.3.5.1 General

The performance is measured by the required SNR at UCI block error probability not exceeding 1%.

The UCI block error probability is defined as the conditional probability of incorrectly decoding the UCI information when the UCI information is sent. The UCI information does not contain CSI part 2.

[The transient period as specified in TS 38.101-1 [3] clause 6.3.3.1 is not taken into account for performance requirement testing, where the RB hopping is symmetric to the centre, i.e. intra-slot frequency hopping is enabled.]

**Table 8.1.3.5.1-1: Test Parameters**

Parameter	Test 1	Test 2
Cyclic Prefix	Normal	
Modulation order	QPSK	
First PRB prior to frequency hopping	0	
Intra-slot frequency hopping	enabled	
First PRB after frequency hopping	The largest PRB index – (Number of PRBs – 1)	
Group and sequence hopping	neither	
Hopping ID	0	
Number of PRBs	1	3
Number of symbols	14	4
The number of UCI information bits	16	16
First symbol	0	0

## 8.1.3.5.2 Minimum requirements

The UCI block error probability shall not exceed 1% at the SNR given in Table 8.2.3.5.2-1 and Table 8.2.3.5.2-2.

**Table 8.2.3.5.2-1: Minimum requirements for PUCCH format 3 with 15 kHz SCS**

Test Number	Number of TX antennas	Number of Demodulation Branches	Additional DM-RS configuration	Channel bandwidth / SNR (dB)		
				5 MHz	10 MHz	20 MHz
1	1	2	No additional DM-RS	0.2	1.1	0.3
			Additional DM-RS	-0.1	0.5	-0.1
		4	No additional DM-RS	-3.8	-3.3	-3.8
			Additional DM-RS	-4.3	-4.0	-4.0
		8	No additional DM-RS	-7.0	-6.7	-6.9
			Additional DM-RS	-7.7	-7.5	-7.7
2	1	2	No additional DM-RS	1.4	2.2	2.0
		4	No additional DM-RS	-3.1	-2.5	-2.5
		8	No additional DM-RS	-6.5	-6.0	-6.2

**Table 8.1.3.5.2-2: Minimum requirements for PUCCH format 3 with 30 kHz SCS**

Test Number	Number of TX antennas	Number of Demodulation Branches	Cyclic Prefix	Propagation conditions and correlation matrix (Annex I)	Additional DM-RS configuration	Channel bandwidth / SNR (dB)			
						10 MHz	20 MHz	40 MHz	100 MHz
1	1	2	Normal	TDLC300-100 Low	No additional DM-RS	0.9	0.6	0.6	0.9
					Additional DM-RS	0.5	0.3	0.0	0.1
		4	Normal	TDLC300-100 Low	No additional DM-RS	-3.1	-3.4	-3.2	-3.5
					Additional DM-RS	-3.7	-4.1	-4.0	-4.2
		8	Normal	TDLC300-100 Low	No additional DM-RS	-6.6	-6.7	-6.8	-6.8
					Additional DM-RS	-7.5	-7.6	-7.6	-7.7
2	1	2	Normal	TDLC300-100 Low	No additional DM-RS	1.8	2.0	2.0	1.5
		4	Normal	TDLC300-100 Low	No additional DM-RS	-2.9	-3.0	-2.4	-3.0
		8	Normal	TDLC300-100 Low	No additional DM-RS	-6.4	-6.0	-6.4	-6.2

## 8.1.3.6 Performance requirements for PUCCH format 4

## 8.1.3.6.1 General

The performance is measured by the required SNR at UCI block error probability not exceeding 1%.

The UCI block error probability is defined as the conditional probability of incorrectly decoding the UCI information when the UCI information is sent. The UCI information does not contain CSI part 2.

[The transient period as specified in TS 38.101-1 [3] clause 6.3.3.1 is not taken into account for performance requirement testing, where the RB hopping is symmetric to the centre, i.e. intra-slot frequency hopping is enabled.]

**Table 8.1.3.6.1-1: Test parameters**

Parameter	Value
Cyclic Prefix	Normal
Modulation order	QPSK
First PRB prior to frequency hopping	0
Number of PRBs	1
Intra-slot frequency hopping	enabled
First PRB after frequency hopping	The largest PRB index – (Number of PRBs – 1)
Group and sequence hopping	neither
Hopping ID	0
Number of symbols	14
The number of UCI information bits	22
First symbol	0
Length of the orthogonal cover code	n2
Index of the orthogonal cover code	n0

#### 8.1.3.6.2 Minimum requirement

The UCI block error probability shall not exceed 1% at the SNR given in Table 8.2.3.6.2-1 and Table 8.2.3.6.2-2.

**Table 8.1.3.6.2-1: Required SNR for PUCCH format 4 with 15 kHz SCS**

Number of TX antennas	Number of Demodulation Branches	Propagation conditions and correlation matrix (Annex I)	Additional DM-RS configuration	Channel bandwidth / SNR (dB)		
				5 MHz	10 MHz	20 MHz
1	2	TDLC300-100 Low	No additional DM-RS	1.8	2.6	2.2
			Additional DM-RS	1.6	2.4	1.8
	4	TDLC300-100 Low	No additional DM-RS	-2.3	-1.9	-2.2
			Additional DM-RS	-2.9	-2.6	-2.7
	8	TDLC300-100 Low	No additional DM-RS	-5.9	-5.7	-5.8
			Additional DM-RS	-6.6	-6.4	-6.3

**Table 8.1.3.6.2-2: Required SNR for PUCCH format 4 with 30 kHz SCS**

Number of TX antennas	Number of Demodulation Branches	Propagation conditions and correlation matrix (Annex I)	Additional DM-RS configuration	Channel bandwidth / SNR (dB)			
				10 MHz	20 MHz	40 MHz	100 MHz
1	2	TDLC300-100 Low	No additional DM-RS	3.1	2.8	3.1	2.8
			Additional DM-RS	2.8	2.3	3.1	2.2
	4	TDLC300-100 Low	No additional DM-RS	-1.7	-1.9	-1.7	-2.1
			Additional DM-RS	-2.0	-2.5	-2.5	-2.4
	8	TDLC300-100 Low	No additional DM-RS	-5.6	-5.5	-5.5	-5.5
			Additional DM-RS	-6.2	-6.1	-6.4	-6.2

**8.1.3.7 Performance requirements for multi-slot PUCCH**

**8.1.3.7.1 General**

**8.1.3.7.2 Performance requirements for multi-slot PUCCH format 1**

**8.1.3.7.2.1 ACK to NACK requirements**

**8.1.3.7.2.1.1 General**

The NACK to ACK detection probability is the probability that an ACK bit is falsely detected when an NACK bit was sent on the particular bit position, where the NACK to ACK detection probability is defined as follows:

$$\text{Prob}(\text{PUCCH NACK} \rightarrow \text{ACK bits}) = \frac{\#(\text{NACK bits decoded as ACK bits})}{\#(\text{Total NACK bits})},$$

where:

- $\#(\text{Total NACK bits})$  denotes the total number of NACK bits transmitted
- $\#(\text{NACK bits decoded as ACK bits})$  denotes the number of NACK bits decoded as ACK bits at the receiver, i.e. the number of received ACK bits
- NACK bits in the definition do not contain the NACK bits which are mapped from DTX, i.e. NACK bits received when DTX is sent should not be considered.

Random codeword selection is assumed.

**Table 8.1.3.7.2.1.1-1: Test Parameters for multi-slot PUCCH format 1**

Parameter	Test
Cyclic Prefix	Normal
Number of information bits	2
Number of PRBs	1
Number of symbols	14
First PRB prior to frequency hopping	0
Intra-slot frequency hopping	disabled
Inter-slot frequency hopping	enabled
First PRB after frequency hopping	The largest PRB index – (nrofPRBs – 1)
Group and sequence hopping	neither
Hopping ID	0
Initial cyclic shift	0
First symbol	0
Index of orthogonal cover code ( <i>timeDomainOCC</i> )	0
Number of slots for PUCCH repetition	2

#### 8.1.3.7.2.1.2 Minimum requirements

The multi-slot NACK to ACK probability shall not exceed 0.1% at the SNR given in table 8.2.3.7.2.1.2-1.

**Table 8.1.3.7.2.1.2-1: Minimum requirements for multi-slot PUCCH format 1 with 30kHz SCS**

Number of TX antennas	Number of RX antennas	Propagation conditions and correlation matrix (Annex I)	Channel bandwidth / SNR (dB)
			40 MHz
1	2	TDLC-300-100 Low	-6.3

#### 8.1.3.7.2.2 ACK missed detection requirements

##### 8.1.3.7.2.2.1 General

The ACK missed detection probability is the probability of not detecting an ACK when an ACK was sent. The test parameters in table 8.2.3.7.2.1.1-1 are configured.

##### 8.1.3.7.2.2.2 Minimum requirements

The multi-slot ACK missed detection probability shall not exceed 1% at the SNR given in table 8.2.3.7.2.2.2-1.

**Table 8.1.3.7.2.2.2-1: Minimum requirements for multi-slot PUCCH format 1 with 30kHz SCS**

Number of TX antennas	Number of RX antennas	Propagation conditions and correlation matrix (Annex I)	Channel bandwidth / SNR (dB)
			40 MHz
1	2	TDLC-300-100 Low	-7.6

## 8.1.4 Performance requirements for PRACH

### 8.1.4.1 PRACH false alarm probability

#### 8.1.4.1.1 General

The false alarm requirement is valid for any number of receive antennas, for any channel bandwidth.

The false alarm probability is the conditional total probability of erroneous detection of the preamble (i.e. erroneous detection from any detector) when input is only noise.

8.1.4.1.2 Minimum requirement

The false alarm probability shall be less than or equal to 0.1%.

8.1.4.2 PRACH detection requirements

8.1.4.2.1 General

The probability of detection is the conditional probability of correct detection of the preamble when the signal is present. There are several error cases – detecting different preamble than the one that was sent, not detecting a preamble at all or correct preamble detection but with the wrong timing estimation. A timing estimation error occurs if the estimation error of the timing of the strongest path is larger than the time error tolerance given in Table 8.1.4.2.1-1.

**Table 8.1.4.2.1-1: Time error tolerance**

PRACH preamble	PRACH SCS (kHz)	Time error tolerance
0	1.25	2.55 us
A1, A2, A3, B4, C0, C2	15	2.03 us
	30	1.77 us

The test preambles for normal mode are listed in table A.2.5-1 and the test parameter *msg1-FrequencyStart* is set to 0.

8.1.4.2.2 Minimum requirements for normal mode

The probability of detection shall be equal to or exceed 99% for the SNR levels listed in Tables 8.1.4.2.2-1 to 8.1.4.2.2-3.

**Table 8.1.4.2.2-1: PRACH missed detection requirements for Normal Mode, 1.25 kHz SCS**

Number of TX antennas	Number of RX antennas	Propagation conditions and correlation matrix (Annex I)	Frequency offset	SNR (dB)
				Burst format 0
1	2	TDLC300-100 Low	400 Hz	-6.6
	4	TDLC300-100 Low	400 Hz	-11.9
	8	TDLC300-100 Low	400 Hz	-15.8

**Table 8.1.4.2.2-2: PRACH missed detection requirements for Normal Mode, 15 kHz SCS**

Number of TX antennas	Number of Demodulation Branches	Propagation conditions and correlation matrix (Annex I)	Frequency offset	SNR (dB)					
				Burst format A1	Burst format A2	Burst format A3	Burst format B4	Burst format C0	Burst format C2
1	2	TDLC300-100 Low	400 Hz	-2.1	-4.8	-6.6	-8.8	0.8	-4.9
	4	TDLC300-100 Low	400 Hz	-7.3	-10.3	-11.7	-13.8	-4.3	-10.2
	8	TDLC300-100 Low	400 Hz	-11.0	-13.9	-15.2	-17.3	-8.1	-13.9



Table 8.1.4.2.2-3: PRACH missed detection requirements for Normal Mode, 30 kHz SCS

Number of TX antennas	Number of Demodulation Branches	Propagation conditions and correlation matrix (Annex I)	Frequency offset	SNR (dB)					
				Burst format A1	Burst format A2	Burst format A3	Burst format B4	Burst format C0	Burst format C2
1	2	TDLC300-100 Low	400 Hz	-2.8	-5.7	-7.4	-9.9	0.1	-5.6
	4	TDLC300-100 Low	400 Hz	-7.2	-10.4	-12.0	-14.5	-4.5	-10.4
	8	TDLC300-100 Low	400 Hz	-10.7	-13.7	-15.1	-17.6	-7.8	-13.7

## 8.2 IAB-MT requirements

### 8.2.1 General

Conducted performance requirements specify the ability of the *IAB-MT type 1-H* to correctly demodulate signals in various conditions and configurations. Conducted performance requirements are specified at the *TAB connector(s)* (for *IAB-MT type 1-H*).

Conducted performance requirements for the IAB-MT are specified for the fixed reference channels defined in annex A and the propagation conditions in annex I. The requirements only apply to those FRCs that are supported by the IAB-MT.

The SNR used in this clause is specified based on a single carrier and defined as:

$$\text{SNR} = S / N$$

Where:

*S* is the total signal energy in the slot on a single *TAB connector* (for *IAB-MT type 1-H*).

*N* is the noise energy in a bandwidth corresponding to the transmission bandwidth over the duration of a slot on a single *TAB connector* (for *IAB-MT type 1-H*).

### 8.2.2 Demodulation performance requirements

#### 8.2.2.1 Performance requirements for PDSCH

##### 8.2.2.1.1 General

The performance requirement of PDSCH is determined by a minimum required throughput for a given SNR. The required throughput is expressed as a fraction of maximum throughput for the FRCs listed in annex A. The performance requirements assume HARQ retransmissions.

Table: 8.2.2.1.1-1 Test parameters for testing PDSCH

Parameter		Value
Cyclic prefix		Normal
Default TDD UL-DL pattern (Note 1)		7D1S2U, S=6D:4G:4U
HARQ	Maximum number of HARQ transmissions	4
	RV sequence	0, 2, 3, 1
DM-RS	DM-RS configuration type	1
	DM-RS duration	single-symbol DM-RS
	DM-RS position ( <i>l<sub>0</sub></i> )	2

	Additional DM-RS position	pos1
	Number of DM-RS CDM group(s) without data	1 for Rank 1 and Rank 2 tests 2 for Rank 3 and Rank 4 tests
	DM-RS port(s)	{1000} for Rank 1 tests {1000-1001} for Rank 2 tests {1000-1002} for Rank 3 tests {1000-1003} for Rank 4 tests
	DM-RS sequence generation	$N_{ID}^0=0$
Time domain resource assignment	PDSCH mapping type	A
	Start symbol	2
	Allocation length	12
Frequency domain resource assignment	RB assignment	Full applicable test bandwidth
PT-RS configuration		Not configured
PRB bundling size		2
VRB-to-PRB mapping type		Not interleaved
PDSCH & PDSCH DMRS Precoding configuration		Single Panel Type I, Random precoder selection updated per slot, with equal probability of each applicable $i_1, i_2$ combination, and with PRB bundling granularity
Note 1: The same requirements are applicable to TDD with different UL-DL patterns.		

### 8.2.2.1.2 Minimum requirements

The throughput shall be equal to or larger than the fraction of maximum throughput for the FRCs stated in tables 8.2.2.1.2-1 to 8.2.2.1.2-4 at the given SNR with the test parameters stated in Table 8.2.2.1.1-1.

**Table 8.2.2.1.2-1: Minimum requirements for PDSCH Type A with Rank 1**

Test number	FRC (Annex A)	Bandwidth (MHz) / Subcarrier spacing (kHz)	Propagation conditions (Annex I)	Antenna configuration	Fraction of maximum throughput (%)	SNR (dB)
1-1	M-FR1-A.3.3-1	40/30	TDLA30-10	2x4, ULA Low	70	21.6
1-2	M-FR1-A.3.1-1	40/30	TDLA30-10	2x4, ULA Low	30	-1.1

**Table 8.2.2.1.2-2: Minimum requirements for PDSCH Type A with Rank 2**

Test number	FRC (Annex A)	Bandwidth (MHz) / Subcarrier spacing (kHz)	Propagation conditions (Annex I)	Antenna configuration	Fraction of maximum throughput (%)	SNR (dB)
2-1	M-FR1-A.3.2-1	40/30	TDLA30-10	2x4, ULA Low	70	13.6

**Table 8.2.2.1.2-3: Minimum requirements for PDSCH Type A with Rank 3**

Test number	FRC (Annex A)	Bandwidth (MHz) / Subcarrier spacing (kHz)	Propagation conditions (Annex I)	Antenna configuration	Fraction of maximum throughput (%)	SNR (dB)
3-1	M-FR1-A.3.1-2	40/30	TDLA30-10	4x4, ULA Low	70	11.4

Table 8.2.2.1.2-4: Minimum requirements for PDSCH Type A with Rank 4

Test number	FRC (Annex A)	Bandwidth (MHz) / Subcarrier spacing (kHz)	Propagation conditions (Annex I)	Antenna configuration	Fraction of maximum throughput (%)	SNR (dB)
4-1	M-FR1-A.3.1-3	40/30	TDLA30-10	4x4, ULA Low	70	15.4

## 8.2.2.2 Performance requirements for PDCCH

### 8.2.2.2.1 General

The receiver characteristics of the PDCCH are determined by the probability of miss-detection of the Downlink Scheduling Grant (Pm-dsg).

Table: 8.2.2.2.1-1 Test parameters for testing PDCCH

Parameter	Value
Cyclic prefix	Normal
Default TDD UL-DL pattern (Note 1)	7D1S2U, S=6D:4G:4U
DM-RS sequence generation	$N_{ID}=0$
Frequency domain resource allocation for CORESET	Start from RB = 0 with contiguous RB allocation
CCE to REG mapping type	Interleaved
Interleaver size	3
REG bundle size	2 for test with 1Tx 6 for test with 2Tx
Shift Index	0
Slots for PDCCH monitoring	Each slot
Number of PDCCH candidates for the tested aggregation level	1
PDCCH Precoding configuration	Single Panel Type I, Random precoder selection updated per slot, with equal probability of each applicable $i_1, i_2$ combination with REG bundling granularity for number of Tx larger than 1
Note 1: The same requirements are applicable to TDD with different UL-DL patterns.	

### 8.2.2.2.2 Minimum requirements

The Pm-dsg shall be equal to or smaller than 1%, for the cases stated in Table 8.2.2.2.2-1 at the given SNR with the test parameters stated in Table 8.2.2.2.1-1.

Table 8.2.2.2.2-1: Minimum requirements for PDCCH

Test number	Bandwidth (MHz) / Subcarrier spacing (kHz)	CORESET RB	CORESET duration	Aggregation level	FRC (Annex A)	Propagation conditions (Annex I)	Antenna configuration	Pm-dsg (%)	SNR (dB)
1	40/30	102	1	2	M-FR1-A.3.4-1	TDLA30-10	1x4, ULA Low	1	2.1
2	40/30	102	1	4	M-FR1-A.3.4-2	TDLA30-10	1x4, ULA Low	1	0.7
3	40/30	90	1	8	M-FR1-A.3.4-3	TDLA30-10	2x4, ULA Low	1	-4.1

## 8.2.3 CSI reporting requirements

### 8.2.3.1 General

This clause includes conducted requirements for the reporting of channel state information (CSI).

#### 8.2.3.1.1 Common test parameters

Parameters specified in Table 8.2.3.1-1 are applied for all test cases in clause 8.2.3 unless otherwise stated.

Table 8.2.3.1-1: Test parameters for CSI test cases

Parameter		Unit	Value
PDSCH transmission scheme			Transmission scheme 1
Duplex mode			TDD
Actual carrier configuration	Offset between Point A and the lowest usable subcarrier on this carrier (Note 2)	RBs	0
	Subcarrier spacing	kHz	30
DL BWP configuration #1	Cyclic prefix		Normal
	RB offset	RBs	0
	Number of contiguous PRB	PRBs	Maximum transmission bandwidth configuration as specified in clause 5.3.2 for tested channel bandwidth and subcarrier spacing
Active DL BWP index			1
Cross carrier scheduling			Not configured
PDSCH configuration	Mapping type		Type A
	$k_0$		0
	Starting symbol (S)		2
	Length (L)		12
	PDSCH aggregation factor		1
	PRB bundling type		Static
	PRB bundling size		2
	Resource allocation type		type 0
	VRB-to-PRB mapping type		Non-interleaved
	VRB-to-PRB mapping interleaver bundle size		N/A
PDSCH DMRS configuration	DMRS Type		Type 1
	Number of additional DMRS		1
	Maximum number of OFDM symbols for DL front loaded DMRS		1
	DMRS ports indexes		{1000} for Rank1 {1000,1001} for Rank2 {1000,1001,1002} for Rank3 {1000,1001,1002,1003} for Rank4
	Number of PDSCH DMRS CDM group(s) without data		2
PTRS configuration	Frequency density ( $K_{PT-RS}$ )		N/A
	Time density ( $L_{PT-RS}$ )		N/A
NZP CSI-RS for CSI acquisition	Frequency Occupation		Start PRB 0 Number of PRB = BWP size
Redundancy version coding sequence			{0,2,3,1}
Physical signals, channels mapping and precoding			As specified in Annex I.3.1
Note 1: PDSCH is not scheduled on slots containing CSI-RS or slots which are not full DL.			
Note 2: Point A coincides with minimum guard band as specified in Table 5.3.3-1 from TS 38.101-1 [3] for tested channel bandwidth and subcarrier spacing.			

## 8.2.3.2 Reporting of Channel Quality Indicator (CQI)

### 8.2.3.2.1 General

The reporting accuracy of the channel quality indicator (CQI) under frequency non-selective conditions is determined by the reporting variance and the BLER performance using the transport format indicated by the reported CQI median. The purpose is to verify that the reported CQI values are in accordance with the CQI definition given in TS 38.214 [11]. To account for sensitivity of the input SNR the reporting definition is considered to be verified if the reporting accuracy is met for at least one of two SNR levels separated by an offset of 1 dB.

**Table 8.2.3.2.1-1: Test parameters for testing CQI reporting**

Parameter		Unit	Test 1	Test 2
Bandwidth		MHz	40	
Subcarrier spacing		kHz	30	
Default TDD UL-DL pattern (Note 1)			7D1S2U, S=6D:4G:4U	
SNR		dB	5	6   11   12
Propagation channel			AWGN	
Antenna configuration			2x4	
Beamforming Model			As specified in Annex 1	
NZP CSI-RS for CSI acquisition	CSI-RS resource Type		Periodic	
	Number of CSI-RS ports (X)		2	
	CDM Type		FD-CDM2	
	Density ( $\rho$ )		1	
	First subcarrier index in the PRB used for CSI-RS ( $k_0, k_1$ )		Row 3,(6,-)	
	First OFDM symbol in the PRB used for CSI-RS ( $l_0$ )		13	
	NZP CSI-RS-timeConfig periodicity and offset	slot	10/1	
ReportConfigType			Periodic	
CQI-table			Table 2	
reportQuantity			cri-RI-PMI-CQI	
cqi-FormatIndicator			Wideband	
pmi-FormatIndicator			Wideband	
Sub-band Size		RB	16	
Csi-ReportingBand			1111111	
CSI-Report periodicity and offset		slot	10/9	
Codebook configuration	Codebook Type		type1-SinglePanel	
	Codebook Mode		1	
	(CodebookConfig-N1, CodebookConfig-N2)		Not configured	
	CodebookSubsetRestriction		010000	
RI Restriction			N/A	
Maximum number of HARQ transmission			1	
Measurement channel			M-FR1-A.3.5-2	
Note 1: The same requirements are applicable for TDD with different UL-DL pattern.				
Note 2: SSB, TRS, CSI-RS, and/or other unspecified test parameters with respect to TS 38.101-4 [28] are left up to test implementation, if transmitted or needed.				

### 8.2.3.2.2 Minimum requirements

For the parameters specified in Table 8.2.3.2.1-1, and using the downlink physical channels specified in Annex A, the minimum requirements are specified by the following:

- The reported CQI value according to the reference channel shall be in the range of  $\pm 1$  of the reported median more than 90% of the time.
- If the PDSCH BLER using the transport format indicated by median CQI is less than or equal to 0.1, then the BLER using the transport format indicated by the (median CQI+1) shall be greater than 0.1. If the PDSCH BLER using the transport format indicated by the median CQI is greater than 0.1, then the BLER using transport format indicated by (median CQI-1) shall be less than or equal to 0.1.

### 8.2.3.3 Reporting of Precoding Matrix Indicator (PMI)

#### 8.2.3.3.1 General

The minimum performance requirements of PMI reporting are defined based on the precoding gain, expressed as the relative increase in throughput when the transmitter is configured according to the IAB-MT reported PMI compared to the case when the transmitter is using random precoding, respectively. When the transmitter uses random precoding, for each PDSCH allocation a precoder is randomly generated with equal probability of each applicable  $i_1$  and  $i_2$  combination and applied to the PDSCH. A fixed transport format (FRC) is configured for all requirements.

The requirements for transmission mode 1 with higher layer parameter *codebookType* set to 'typeI-SinglePanel' are specified in terms of the ratio:

$$\gamma = \frac{t_{ue, follow1, follow2}}{t_{rnd1, rnd2}}$$

In the definition of  $\gamma$ , for 4TX, 8TX PMI requirements,  $t_{follow1, follow2}$  is 90 % of the maximum throughput obtained at  $SNR_{follow1, follow2}$  using the precoders configured according to the IAB-MT reports, and  $t_{rnd1, rnd2}$  is the throughput measured at  $SNR_{follow1, follow2}$  with random precoding.

Table 8.2.3.3.1-1: Test parameters for testing PMI reporting

Parameter		Unit	Test 1	Test 2
Bandwidth		MHz	40	
Subcarrier spacing		kHz	30	
TDD DL-UL configuration (Note 1)			7D1S2U, S=6D:4G:4U	
Propagation channel			TDLA30-5	
Antenna configuration			High XP 4 x 4 (N1,N2) = (2,1)	High XP 8 x 4 (N1,N2) = (4,1)
Beamforming Model			As specified in Annex I.3.1	
NZIP CSI-RS for CSI acquisition	CSI-RS resource Type		Periodic	
	Number of CSI-RS ports (X)		4	8
	CDM Type		FD-CDM2	CDM4 (FD2, TD2)
	Density ( $\rho$ )		1	
	First subcarrier index in the PRB used for CSI-RS ( $k_0, k_1$ )		Row 4, (0,-)	Row 8, (4,6)
	First OFDM symbol in the PRB used for CSI-RS ( $l_0, l_1$ )		(13,-)	(5,-)
	NZIP CSI-RS- timeConfig periodicity and offset	slot	10/1	
ReportConfigType			Periodic	
CQI-table			Table 1	
reportQuantity			cri-RI-PMI-CQI	
cqi-FormatIndicator			Wideband	
pmi-FormatIndicator			Wideband	
Sub-band Size		RB	16	
csi-ReportingBand			1111111	
CSI-Report interval and offset		slot	Not configured	
CSI-Report periodicity and offset			10/9	
Codebook configuration	Codebook Type		type1-SinglePanel	
	Codebook Mode		1	
	(CodebookConfig- N1, CodebookConfig- N2)		(2,1)	(4,1)
	(CodebookConfig- O1, CodebookConfig- O2)		(4,1)	
	CodebookSubsetR restriction		11111111	0x FFFF
RI Restriction			00000001	00000010
CQI/RI/PMI delay		ms	5.5	6.5
Maximum number of HARQ transmission			4	
Measurement channel			M-FR1-A.3.5-5	M-FR1-A.3.5-6
Note 1: The same requirements are applicable for TDD with different UL-DL pattern.				
Note 2: When Throughput is measured using random precoder selection, the precoder shall be updated in each slot (0.5 ms granularity) with equal probability of each applicable $i_1, i_2$ combination.				
Note 3: If the IAB-MT reports in an available uplink reporting instance at slot#n based on PMI estimation at a downlink slot not later than slot#(n-4) for test 1 and not later than slot#(n-6) for test 2, this reported PMI cannot be applied at the gNB downlink before slot#(n+4) for test 1 and before slot#(n+6) for test 2.				
Note 4: Randomization of the principle beam direction shall be used as specified in I.2.4.3.5.				
Note 5: SSB, TRS, CSI-RS, and/or other unspecified test parameters with respect to TS 38.101-4 [28] are left up to test implementation, if transmitted or needed.				



### 8.2.3.3.2 Minimum requirements

For the parameters specified in Table 8.2.3.2.1-1 and using the downlink physical channels specified in Annex A, the minimum requirements are specified in Table 8.2.3.2.2-1:

**Table 8.2.3.2.2-1: Minimum requirement for PMI reporting**

Parameter	Test 1	Test 2
$\gamma$	1.3	1.5

### 8.2.3.4 Reporting of Rank Indicator (RI)

#### 8.2.3.4.1 General

The purpose of this test is to verify that the reported rank indicator accurately represents the channel rank. The accuracy of RI reporting is determined by the relative increase of the throughput obtained when transmitting based on the reported rank compared to the case for which a fixed rank is used for transmission.

Table 8.2.3.4.1-1: Test parameters for testing RI reporting

Parameter		Unit	Test 1	Test 2	Test 3	Test 4
Bandwidth		MHz	40			
Subcarrier spacing		kHz	30			
Default TDD UL-DL pattern (Note 1)			7D1S2U, S=6D:4G:4U			
SNR		dB	-2	16	16	22
Propagation channel			TDLA30-5			
Antenna configuration			ULA Low 2x4	ULA Low 2x4	ULA High 2x4	ULA Low 4x4
Beamforming Model			As defined in Annex I.3.1			
NZIP CSI-RS for CSI acquisition	CSI-RS resource Type		Periodic			
	Number of CSI-RS ports (X)		2	2	2	4
	CDM Type		FD-CDM2			
	Density (ρ)		1			
	First subcarrier index in the PRB used for CSI-RS (k <sub>0</sub> , k <sub>1</sub> )		Row 3 (6,-)	Row 3 (6,-)	Row 3 (6,-)	Row 4 (0,-)
	First OFDM symbol in the PRB used for CSI-RS (l <sub>0</sub> , l <sub>1</sub> )		(13, -)			
	NZIP CSI-RS-timeConfig periodicity and offset	slot	10/1			
ReportConfigType			Periodic			
CQI-table			Table 2			
reportQuantity			cri-RI-PMI-CQI			
cqi-FormatIndicator			Wideband			
pmi-FormatIndicator			Wideband			
Sub-band Size		RB	16			
csi-ReportingBand			1111111			
CSI-Report periodicity and offset		slot	10/9			
Codebook configuration	Codebook Type		type1-SinglePanel			
	Codebook Mode		1			
	(CodebookConfig-N1, CodebookConfig-N2)		N/A	N/A	N/A	(2,1)
	CodebookSubsetRestriction		010000 for fixed rank 2, 010011 for following rank	000011 for fixed rank 1, 010011 for following rank	000011 for fixed rank 1, 010011 for following rank	11111111
	RI Restriction		N/A	N/A	N/A	00000010 for fixed Rank 2 and 00001111 for follow RI
CQI/RI/PMI delay		ms	9.5			
Maximum number of HARQ transmission			1			
RI Configuration			Fixed RI = 2 and follow RI	Fixed RI = 1 and follow RI	Fixed RI = 1 and follow RI	Fixed RI = 2 and follow RI
Note 1: The same requirements are applicable for TDD with different UL-DL pattern.						
Note 2: SSB, TRS, CSI-RS, and/or other unspecified test parameters with respect to TS 38.101-4 [28] are left up to test implementation, if transmitted or needed.						
Note 3: Measurements channels are specified in Table A.3.5-1. M-FR1-A.3.5-1 is used for Rank 1 case. M-FR1-A.3.5-2 is used for Rank 2 case. M-FR1-A.3.5-3 is used for Rank 3 case. M-FR1-A.3.5-4 is used for Rank 4 case.						

### 8.2.3.4.2 Minimum requirements

The minimum performance requirement in Table 8.2.3.4.2-1 is defined as

- The ratio of the throughput obtained when transmitting based on IAB-MT reported RI and that obtained when transmitting with fixed rank 1 shall be  $\geq \gamma_1$ ;
- The ratio of the throughput obtained when transmitting based on IAB-MT reported RI and that obtained when transmitting with fixed rank 2 shall be  $\geq \gamma_2$ ;

For the parameters specified in Table 8.2.3.3.1-1 and using the downlink physical channels specified in Annex A, the minimum requirements are specified in Table 8.2.3.4.2-1.

Table 8.2.3.4.2-1: Minimum requirement for RI reporting

	Test 1	Test 2	Test 3	Test 4
$\gamma_1$	N/A	1.05	0.9	N/A
$\gamma_2$	0.9	N/A	N/A	0.9

## 9 Radiated transmitter characteristics

### 9.1 General

Radiated transmitter characteristics requirements apply on the *IAB-DU* and *IAB-MT type 1-H*, *IAB-DU* and *IAB-MT type 1-O*, or *IAB-DU* and *IAB-MT type 2-O* including all its functional components active and for all foreseen modes of operation unless otherwise stated.

For *IAB-MT type 1-O* manufacturer shall also declare  $N_{TXU,OTAactive}$ .  $N_{TXU,OTAactive}$  active transmitter units supporting the same *operating band* is implementation dependent.

The number of *active transmitter units* that are considered when calculating the radiated TX emissions limits ( $N_{TXU,OTApercell}$ ) for *IAB-MT type 1-O* is calculated as follows:

$$N_{TXU,OTApercell} = \min(N_{TXU,OTAactive}, 8)$$

$N_{TXU,OTApercell}$  is used for scaling of *basic limits*.

### 9.2 Radiated transmit power

#### 9.2.1 General

*IAB-DU* and *IAB-MT type 1-H*, *IAB-DU* and *IAB-MT type 1-O* and *IAB-DU* and *IAB-MT type 2-O* are declared to support one or more beams, as per manufacturer's declarations. Radiated transmit power is defined as the EIRP level for a declared beam at a specific *beam peak direction*. Declarations are done for *IAB-DU* and *IAB-MT* separately.

For each beam, the requirement is based on declaration of a beam identity, *reference beam direction pair*, beamwidth, *rated beam EIRP*, *OTA peak directions set*, the *beam direction pairs* at the maximum steering directions and their associated *rated beam EIRP* and beamwidth(s).

For a declared beam and *beam direction pair*, the *rated beam EIRP* level is the maximum power that the base station is declared to radiate at the associated *beam peak direction* during the *transmitter ON period*.

For each *beam peak direction* associated with a *beam direction pair* within the *OTA peak directions set*, a specific *rated beam EIRP* level may be claimed. Any claimed value shall be met within the accuracy requirement as described below. *Rated beam EIRP* is only required to be declared for the *beam direction pairs* subject to conformance testing.

NOTE 1: *OTA peak directions set* is set of *beam peak directions* for which the EIRP accuracy requirement is intended to be met. The *beam peak directions* are related to a corresponding contiguous range or discrete list of *beam centre directions* by the *beam direction pairs* included in the set.

NOTE 2: A *beam direction pair* is data set consisting of the *beam centre direction* and the related *beam peak direction*.

NOTE 3: A declared EIRP value is a value provided by the manufacturer for verification according to the conformance specification declaration requirements, whereas a claimed EIRP value is provided by the manufacturer to the equipment user for normal operation of the equipment and is not subject to formal conformance testing.

For *operating bands* where the supported *fractional bandwidth (FBW)* is larger than 6%, two rated carrier EIRP may be declared by manufacturer:

- $P_{\text{rated,c,FBWlow}}$  for lower supported frequency range, and
- $P_{\text{rated,c,FBWhigh}}$  for higher supported frequency range.

For frequencies in between  $F_{\text{FBWlow}}$  and  $F_{\text{FBWhigh}}$  the rated carrier EIRP is:

- $P_{\text{rated,c,FBWlow}}$ , for the carrier whose carrier frequency is within frequency range  $F_{\text{FBWlow}} \leq f < (F_{\text{FBWlow}} + F_{\text{FBWhigh}}) / 2$ ,
- $P_{\text{rated,c,FBWhigh}}$ , for the carrier whose carrier frequency is within frequency range  $(F_{\text{FBWlow}} + F_{\text{FBWhigh}}) / 2 \leq f \leq F_{\text{FBWhigh}}$ .

## 9.2.2 Minimum requirement for IAB-DU type 1-H, IAB-DU type 1-O, IAB-MT type 1-H and IAB-MT type 1-O

For each declared beam, in normal conditions, for any specific *beam peak direction* associated with a *beam direction pair* within the *OTA peak directions set*, a manufacturer claimed EIRP level in the corresponding *beam peak direction* shall be achievable to within  $\pm 2.2$  dB of the claimed value.

For *IAB type 1-O* only, for each declared beam, in extreme conditions, for any specific *beam peak direction* associated with a *beam direction pair* within the *OTA peak directions set*, a manufacturer claimed EIRP level in the corresponding *beam peak direction* shall be achievable to within  $\pm 2.7$  dB of the claimed value.

Normal and extreme conditions are defined in TS 38.141-2 [21], annex B.

In certain regions, the minimum requirement for normal conditions may apply also for some conditions outside the range of conditions defined as normal.

## 9.2.3 Minimum requirement for IAB-DU type 2-O and IAB-MT type 2-O

For each declared beam, in normal conditions, for any specific *beam peak direction* associated with a *beam direction pair* within the *OTA peak directions set*, a manufacturer claimed EIRP level in the corresponding *beam peak direction* shall be achievable to within  $\pm 3.4$  dB of the claimed value.

For each declared beam, in extreme conditions, for any specific *beam peak direction* associated with a *beam direction pair* within the *OTA peak directions set*, a manufacturer claimed EIRP level in the corresponding *beam peak direction* shall be achievable to within  $\pm 4.5$  dB of the claimed value.

Normal and extreme conditions are defined in TS 38.141-2 [21], annex B.

In certain regions, the minimum requirement for normal conditions may apply also for some conditions outside the range of conditions defined as normal.

## 9.2.4 Configured radiated output power

### 9.2.4.1 IAB-MT configured output power for IAB-MT type 1-H, 1-O and 2-O

The configured maximum output power  $P_{\text{CMAX,f,c}}$  is set in each slot according to the following equation:

$$P_{\text{CMAX,f,c}} = P_{\text{Rated,c,EIRP}}$$

where  $P_{\text{Rated,c,EIRP}}$  is declared by manufacturer.

## 9.3 OTA IAB output power

### 9.3.1 General

OTA IAB output power is declared as the TRP radiated requirement, with the output power accuracy requirement defined at the RIB during the *transmitter ON period*. TRP does not change with beamforming settings as long as the *beam peak direction* is within the *OTA peak directions set*. Thus the TRP accuracy requirement must be met for any beamforming setting for which the *beam peak direction* is within the *OTA peak directions set*. Declarations are made separately for IAB-DU and IAB-MT.

The IAB *rated carrier TRP output power* for IAB type 1-O shall be within limits as specified in table 9.3.1-1 for IAB-DU type 1-O and in table 9.3.1-2 for IAB-MT type 1-O.

**Table 9.3.1-1: IAB-DU rated carrier TRP output power limits for IAB-DU type 1-O**

IAB-DU class	$P_{\text{rated,c,TRP}}$
Wide Area IAB-DU	(note)
Medium Range IAB-DU	$\leq + 47$ dBm
Local Area IAB-DU	$\leq + 33$ dBm
NOTE: There is no upper limit for the $P_{\text{rated,c,TRP}}$ of the Wide Area IAB-DU	

**Table 9.3.1-2: IAB-MT rated carrier TRP output power limits for IAB-MT type 1-O**

IAB-MT class	$P_{\text{rated,c,TRP}}$
Wide Area IAB-MT	(note)
Local Area IAB-MT	$\leq 24$ dBm + $10\log(N_{\text{TXU, OTApercell}})$
NOTE: There is no upper limit for the $P_{\text{rated,c,TRP}}$ of the Wide Area IAB-MT.	

There is no upper limit for the *rated carrier TRP output power* of IAB type 2-O.

Despite the general requirements for the IAB output power described in clauses 9.3.2 – 9.3.3, additional regional requirements might be applicable.

NOTE: In certain regions, power limits corresponding to IAB classes may apply for IAB type 2-O.

### 9.3.2 Minimum requirement for IAB-DU type 1-O and IAB-MT type 1-O

In normal conditions, the IAB type 1-O *maximum carrier TRP output power*,  $P_{\text{max,c,TRP}}$  measured at the RIB shall remain within  $\pm 2$  dB of the *rated carrier TRP output power*  $P_{\text{rated,c,TRP}}$ , as declared by the manufacturer.

Normal conditions are defined in TS 38.141-1 [22], annex B.

### 9.3.3 Minimum requirement for IAB type 2-O

In normal conditions, the IAB type 2-O *maximum carrier TRP output power*,  $P_{\text{max,c,TRP}}$  measured at the RIB shall remain within  $\pm 3$  dB of the *rated carrier TRP output power*  $P_{\text{rated,c,TRP}}$ , as declared by the manufacturer.

Normal conditions are defined in TS 38.141-2 [21], annex B.

## 9.4 OTA output power dynamics

### 9.4.1 IAB-DU OTA Output Power Dynamics

#### 9.4.1.1 General

The requirements in clause 9.4 apply during the *transmitter ON period*. Transmit signal quality (as specified in clause 9.6) shall be maintained for the output power dynamics requirements.

The OTA output power requirements are *directional requirements* and apply to the *beam peak directions* over the *OTA peak directions set*.

### 9.4.1.2 OTA RE power control dynamic range

#### 9.4.1.2.1 General

The OTA RE power control dynamic range is the difference between the power of an RE and the average RE power for a BS at maximum output power ( $P_{\max,c,EIRP}$ ) for a specified reference condition.

This requirement shall apply at each RIB supporting transmission in the *operating band*.

#### 9.4.1.2.2 Minimum requirement for *IAB-DU type 1-O*

The OTA RE power control dynamic range is specified the same as the conducted RE power control dynamic range requirement for BS *type 1-H* in TS 38.104x[2], subclause 6.3.2.2.

### 9.4.1.3 OTA total power dynamic range

#### 9.4.1.3.1 General

The OTA total power dynamic range is the difference between the maximum and the minimum transmit power of an OFDM symbol for a specified reference condition.

This requirement shall apply at each RIB supporting transmission in the *operating band*.

NOTE 1: The upper limit of the OTA total power dynamic range is the IAB-DU maximum carrier EIRP ( $P_{\max,c,EIRP}$ ) when transmitting on all RBs. The lower limit of the OTA total power dynamic range is the average EIRP for single RB transmission in the same direction using the same beam. The OFDM symbol carries PDSCH and not contain RS or SSB.

#### 9.4.1.3.2 Minimum requirement for *IAB-DU type 1-O*

The OTA total power dynamic range is specified the same as the total power dynamic range requirement for BS *type 1-H* in TS 38.104x[2], subclause 6.3.3.2, where references to *BS channel bandwidth* apply to *IAB-DU channel bandwidth*.

#### 9.4.1.3.3 Minimum requirement for *IAB-DU type 2-O*

The OTA total power dynamic range is specified the same as the OTA total power dynamic range requirement for BS *type 2-O* in TS 38.104x[2], subclause 9.4.3.3.

## 9.4.2 IAB-MT OTA Output Power Dynamics

### 9.4.2.1 OTA total power dynamic range

#### 9.4.2.1.1 General

The OTA total power dynamic range is the difference between the maximum and the minimum controlled transmit power in the channel bandwidth for a specified reference condition. The maximum and minimum output powers are defined as the mean power in at least one sub-frame 1ms

Note. The specified reference condition(s) are specified in the conformance specification. Changes in the controlled transmit power in the channel bandwidth due to changes in the specified reference condition are not include as part of the dynamic range.

This requirement shall apply at each RIB supporting transmission in the *operating band*.

#### 9.4.2.1.2 Minimum requirement for IAB-MT type 1-O

For a wide area IAB-MT the total power dynamic range for each NR carrier shall be larger than or equal to 5 dB.

For a local area IAB-MT the total power dynamic range for each NR carrier shall be larger than or equal to 10 dB.

#### 9.4.2.1.3 Minimum requirement for IAB-MT type 2-O

For a wide area IAB-MT the total power dynamic range for each NR carrier shall be larger than or equal to 5 dB.

For a local area IAB-MT the total power dynamic range for each NR carrier shall be larger than or equal to 10 dB.

### 9.4.3 Power control

#### 9.4.3.1 Power control for local area IAB-MT type 1-O

##### 9.4.3.1.1 Relative EIRP tolerance for local area IAB-MT type 1-O

The relative EIRP tolerance is the ability of the transmitter to set its radiated output power in a target sub-frame (1 ms) relatively to the power of the most recently transmitted reference sub-frame (1 ms) if the transmission gap between these sub-frames is 20 ms.

The minimum requirements specified in Table 9.4.3.1.1-1 apply only when the output power is within the limits set by declared maximum output power and specified dynamic range.

2 exceptions are allowed for each of two test patterns. The test patterns are a monotonically increasing power sweep and a monotonically decreasing power sweep. For those exceptions, the power tolerance limit is a maximum of [ $\pm 11.0$  dB] in Table 9.4.3.1.1-1.

**Table 9.4.3.1.1-1: Relative EIRP tolerance for local area IAB-MT type 1-O**

Power step $\Delta P$ (Up or down) (dB)	EIRP tolerance (dB)
$\Delta P < 2$	[ $\pm 2.5$ ]
$2 \leq \Delta P < 3$	[ $\pm 3.5$ ]
$3 \leq \Delta P < 4$	[ $\pm 4.5$ ]
$4 \leq \Delta P < 10$	[ $\pm 5.5$ ]

##### 9.4.3.1.2 Aggregate EIRP tolerance for local area IAB-MT type 1-O

The aggregate EIRP control tolerance is the ability of the transmitter to maintain its EIRP in a sub-frame (1 ms) during non-contiguous transmissions within [21ms] in response to 0 dB TPC commands with respect to the first UE transmission and all other power control parameters as specified in 3GPP TS 38.213 [10] kept constant.

The minimum requirements specified in Table 9.4.3.1.2-1 apply only when the output power is within the limits set by declared maximum output power and specified dynamic range.

**Table 9.4.3.1.2-1: Aggregate power tolerance for local area IAB-MT type 1-O**

TPC command	UL channel	Aggregate EIRP tolerance within [21 ms]
0 dB	PUCCH	[ $\pm 2.5$ dB]
0 dB	PUSCH	[ $\pm 3.5$ dB]

### 9.4.3.2 Power control for local area IAB-MT type 2-O

#### 9.4.3.2.1 Relative EIRP tolerance for local area IAB-MT type 2-O

The relative EIRP tolerance is the ability of the transmitter to set its radiated output power in a target sub-frame (1 ms) relatively to the power of the most recently transmitted reference sub-frame (1 ms) if the transmission gap between these sub-frames is 20 ms.

The minimum requirements specified in Table 9.4.3.1.1-1 apply only when the output power is within the limits set by declared maximum output power and specified dynamic range.

2 exceptions are allowed for each of two test patterns. The test patterns are a monotonically increasing power sweep and a monotonically decreasing power sweep. For those exceptions, the power tolerance limit is a maximum of  $[\pm 11.0 \text{ dB}]$  in Table 9.4.3.1.1-1.

**Table 9.4.3.2.1-1: Relative EIRP tolerance for local area IAB-MT type 2-O**

Power step $\Delta P$ (Up or down) (dB)	EIRP tolerance (dB)
$\Delta P < 2$	$[\pm 3.0]$
$2 \leq \Delta P < 3$	$[\pm 4.0]$
$3 \leq \Delta P < 4$	$[\pm 5.0]$
$4 \leq \Delta P < 10$	$[\pm 6.0]$

#### 9.4.3.2.2 Aggregate EIRP tolerance for local area IAB-MT type 2-O

The aggregate EIRP control tolerance is the ability of the transmitter to maintain its EIRP in a sub-frame (1 ms) during non-contiguous transmissions within [21ms] in response to 0 dB TPC commands with respect to the first UE transmission and all other power control parameters as specified in 3GPP TS 38.213 [10] kept constant.

The minimum requirements specified in Table 9.4.3.1.2-1 apply only when the output power is within the limits set by declared maximum output power and specified dynamic range.

**Table 9.4.3.2.2-1: Aggregate power tolerance for local area IAB-MT type 2-O**

TPC command	UL channel	Aggregate EIRP tolerance within [21 ms]
0 dB	PUCCH	$[\pm 3.5 \text{ dB}]$
0 dB	PUSCH	$[\pm 3.5 \text{ dB}]$

## 9.5 OTA transmit ON/OFF power

### 9.5.1 General

OTA transmit ON/OFF power requirements apply to TDD operation of IAB-DU and TDD operation of IAB-MT.

### 9.5.2 OTA transmitter OFF power

#### 9.5.2.1 General

OTA transmitter OFF power is defined as the mean power measured over  $70/N \mu\text{s}$  filtered with a square filter of bandwidth equal to the *transmission bandwidth configuration* of the IAB ( $BW_{\text{Config}}$ ) centred on the assigned channel frequency during the *transmitter OFF period*.  $N = \text{SCS}/15$ , where SCS is Sub Carrier Spacing in kHz.

For IAB supporting intra-band contiguous CA, the OTA transmitter OFF power is defined as the mean power measured over  $70/N \mu\text{s}$  filtered with a square filter of bandwidth equal to the *Aggregated IAB-DU or IAB-MT Channel Bandwidth*  $BW_{\text{Channel\_CA}}$  centred on  $(F_{\text{edge,high}} + F_{\text{edge,low}})/2$  during the *transmitter OFF period*.  $N = \text{SCS}/15$ , where SCS is the smallest



supported Sub Carrier Spacing in kHz in the *Aggregated IAB-DU Channel Bandwidth* or *Aggregated IAB-MT Channel Bandwidth*.

For *IAB type 1-O*, the transmitter OFF power is defined as the output power at the *co-location reference antenna* conducted output(s). For *IAB type 2-O* the transmitter OFF power is defined as TRP.

For *multi-band RIBs* and *single band RIBs* supporting transmission in multiple bands, the requirement is only applicable during the *transmitter OFF period* in all supported *operating bands*.

### 9.5.2.2 Minimum requirement for IAB-DU type 1-O

The BS requirements specified in 9.5.2.2 in TS 38.104 [2] apply to *IAB-DU type 1-O*.

### 9.5.2.3 Minimum requirement for IAB-DU type 2-O

The BS requirements specified in 9.5.2.3 in TS 38.104 [2] apply to *IAB-DU type 2-O*.

### 9.5.2.4 Minimum requirement for IAB-MT type 1-O

The BS requirements specified in 9.5.2.2 in TS 38.104 [2] apply to *IAB-MT type 1-O*.

### 9.5.2.5 Minimum requirement for IAB-MT type 2-O

The BS requirements specified in 9.5.2.3 in TS 38.104 [2] apply to *IAB-DU type 2-O*.

## 9.5.3 OTA transient period

### 9.5.3.1 General

The *OTA transmitter transient period* is the time period during which the transmitter is changing from the *transmitter OFF period* to the *transmitter ON period* or vice versa. The *transmitter transient period* is illustrated in figure 6.4.2.1-1 for IAB-DU and IAB-MT.

This requirement shall be applied at each RIB supporting transmission in the *operating band*.

### 9.5.3.2 Minimum requirement for IAB-DU type 1-O

The BS requirements specified in 9.5.3.2 in TS 38.104 [2] apply to *IAB-DU type 1-O*.

### 9.5.3.3 Minimum requirement for IAB-DU type 2-O

The BS requirements specified in 9.5.3.3 in TS 38.104 [2] apply to *IAB-DU type 2-O*.

### 9.5.3.4 Minimum requirement for IAB-MT type 1-O

The BS requirements specified in 9.5.3.2 in TS 38.104 [2] apply to *IAB-MT type 1-O*.

### 9.5.3.5 Minimum requirement for IAB-MT type 2-O

The BS requirements specified in 9.5.3.3 in TS 38.104 [2] apply to *IAB-MT type 2-O*.

## 9.6 OTA transmitted signal quality

### 9.6.1 OTA frequency error

#### 9.6.1.1 IAB-DU OTA frequency error

The requirements in clause 9.6.1 for BS type 1-O and type 2-O in TS 38.104 [2] apply to IAB-DU type 1-O and type 2-O respectively.

#### 9.6.1.2 IAB-MT OTA frequency error

##### 9.6.1.2.1 General

The requirements in subclause 9.6.1.2 apply to the *transmitter ON period*. OTA frequency error requirement is defined as a *directional requirement* at the RIB and shall be met within the *OTA coverage range*.

##### 9.6.1.2.2 Minimum requirement for IAB-MT type 1-O

The IAB-MT basic measurement interval of modulated carrier frequency is 1 UL slot. The mean value of basic measurements of IAB-MT modulated carrier frequency shall be accurate to within  $\pm 0.1$  PPM observed over a period of 1 msec of cumulated measurement intervals compared to the carrier frequency received from the parent node.

##### 9.6.1.2.3 Minimum requirement for IAB-MT type 2-O

The IAB-MT basic measurement interval of modulated carrier frequency is 1 UL slot. The mean value of basic measurements of IAB-MT modulated carrier frequency shall be accurate to within  $\pm 0.1$  PPM observed over a period of 1 msec of cumulated measurement intervals compared to the carrier frequency received from the parent node.

## 9.6.2 OTA modulation quality

### 9.6.2.1 IAB-DU OTA modulation quality

The requirements in clause 9.6.2 for BS type 1-O and type 2-O in TS 38.104 [2] apply to IAB-DU type 1-O and type 2-O respectively.

NOTE: When the indicated IAB-MT transmission timing mode is set to 'Case6' as specified in 3GPP TS 38.213 [10], the power imbalance for simultaneous transmission between IAB-DU and IAB-MT under which the system can be operated is declared by manufacturer.

### 9.6.2.2 IAB-MT OTA modulation quality

#### 9.6.2.2.1 General

Modulation quality is defined by the difference between the measured carrier signal and an ideal signal. Modulation quality can e.g. be expressed as Error Vector Magnitude (EVM). Details about how the EVM is determined are specified in Annex D for FR1 and Annex E for FR2-1.

OTA modulation quality requirement is defined as a *directional requirement* at the RIB and shall be met within the *OTA coverage range*.

NOTE: When the indicated IAB-MT transmission timing mode is set to 'Case6' as specified in 3GPP TS 38.213 [10], the power imbalance for simultaneous transmission between IAB-DU and IAB-MT under which the system can be operated is declared by manufacturer.

#### 9.6.2.2.2 Minimum requirement for IAB-MT type 1-O

For IAB-MT type 1-O, the EVM levels of each NR carrier for different modulation schemes outlined in table 6.5.2.2.2-1 shall be met. Requirements shall be the same as clause 6.5.2.2.2.

### 9.6.2.2.3 Minimum requirement for IAB-MT type 2-O

For IAB-MT type 2-O, the EVM levels of each NR carrier for different modulation schemes outlined in table 9.6.2.2.3-1 shall be met, following the EVM frame structure described in clause 9.6.2.2.4.

**Table 9.6.2.2.3-1: Minimum requirements for error vector magnitude**

Parameter	Unit	Average EVM level
QPSK	%	17.5
16 QAM	%	12.5
64 QAM	%	8.0

### 9.6.2.2.4 EVM frame structure for measurement

EVM shall be evaluated for each NR carrier over all allocated resource blocks and uplink subframes. Different modulation schemes listed in table 9.6.2.2.3-1 shall be considered for rank 1.

For NR, for all bandwidths, the EVM measurement shall be performed for each NR carrier over all allocated resource blocks and uplink subframes within 10 ms measurement periods. The boundaries of the EVM measurement periods need not be aligned with radio frame boundaries.

## 9.6.3 OTA time alignment error

### 9.6.3.1 IAB-DU OTA time alignment error

The requirements in clause 9.6.3 for BS type 1-O and type 2-O in TS 38.104 [2] apply to IAB-DU type 1-O and type 2-O respectively.

### 9.6.4 Timing error between IAB-DU and IAB-MT of the same IAB-Node

When the indicated IAB-MT transmission timing mode is set to 'Case6' as specified in 3GPP TS 38.213 [10] and IAB-DU and IAB-MT of the same IAB-Node are transmitting simultaneously, the timing error between transmission timing of IAB-DU and IAB-MT shall not exceed 3µs.

## 9.7 OTA unwanted emissions

### 9.7.1 General

Unwanted emissions consist of so-called out-of-band emissions and spurious emissions according to ITU definitions ITU-R SM.329 [16]. In ITU terminology, out of band emissions are unwanted emissions immediately outside the *channel bandwidth* resulting from the modulation process and non-linearity in the transmitter but excluding spurious emissions. Spurious emissions are emissions which are caused by unwanted transmitter effects such as harmonics emission, parasitic emission, intermodulation products and frequency conversion products, but exclude out of band emissions.

The OTA out-of-band emissions requirement for the *IAB-MT type 1-O*, *IAB-DU type 1-O*, *IAB-DU type 1-O* and *IAB-DU type 2-O* transmitter is specified both in terms of Adjacent Channel Leakage power Ratio (ACLR) and operating band unwanted emissions (OBUE). OTA Unwanted emissions outside of this frequency range are limited by an OTA spurious emissions requirement.

The maximum offset of the operating band unwanted emissions mask from the *operating band* edge is  $\Delta f_{\text{OBUE}}$ . The value of  $\Delta f_{\text{OBUE}}$  is defined in table 9.7.1-1 *IAB-DU type 1-O* and *type 2-O* and in table 9.7.1-2 *IAB-MT type 1-O* and *type 2-O* for NR *operating bands*.

**Table 9.7.1-1: Maximum offset  $\Delta f_{\text{OBUE}}$  outside the downlink operating band for IAB-DU**

IAB-DU type	Operating band characteristics	$\Delta f_{\text{OBUE}}$ (MHz)
IAB-DU type 1-O	$F_{\text{DL,high}} - F_{\text{DL,low}} < 100$ MHz	10
	$100 \text{ MHz} \leq F_{\text{DL,high}} - F_{\text{DL,low}} \leq 900$ MHz	40
IAB-DU type 2-O	$F_{\text{DL,high}} - F_{\text{DL,low}} \leq 4000$ MHz	1500

**Table 9.7.1-2: Maximum offset  $\Delta f_{\text{OBUE}}$  outside the uplink operating band for IAB-MT**

IAB-MT type	Operating band characteristics	$\Delta f_{\text{OBUE}}$ (MHz)
IAB-MT type 1-O	$F_{\text{UL,high}} - F_{\text{UL,low}} < 100$ MHz	10
	$100 \text{ MHz} \leq F_{\text{UL,high}} - F_{\text{UL,low}} \leq 900$ MHz	40
IAB-MT type 2-O	$F_{\text{UL,high}} - F_{\text{UL,low}} \leq 4000$ MHz	1500

The unwanted emission requirements are applied per cell for all the configurations. Requirements for OTA unwanted emissions are captured using TRP, *directional requirements* or co-location requirements as described per requirement.

There is in addition a requirement for occupied bandwidth.

## 9.7.2 OTA occupied bandwidth

### 9.7.2.1 General

The OTA occupied bandwidth is the width of a frequency band such that, below the lower and above the upper frequency limits, the mean powers emitted are each equal to a specified percentage  $\beta/2$  of the total mean transmitted power. See also recommendation ITU-R SM.328 [3].

The value of  $\beta/2$  shall be taken as 0.5%.

The OTA occupied bandwidth requirement shall apply during the *transmitter ON period* for a single transmitted carrier. The minimum requirement below may be applied regionally. There may also be regional requirements to declare the OTA occupied bandwidth according to the definition in the present clause.

The OTA occupied bandwidth is defined as a *directional requirement* and shall be met in the manufacturer's declared *OTA coverage range* at the RIB.

### 9.7.2.2 Minimum requirement for IAB-DU type 1-O and IAB-DU type 2-O

The OTA occupied bandwidth for each NR carrier shall be less than the *IAB-DU channel bandwidth*. For intra-band contiguous CA, the OTA occupied bandwidth shall be less than or equal to the *Aggregated IAB-DU Channel Bandwidth*.

### 9.7.2.3 Minimum requirement for IAB-MT type 1-O and IAB-MT type 2-O

The OTA occupied bandwidth for each NR carrier shall be less than the *IAB-MT channel bandwidth*. For intra-band contiguous CA, the OTA occupied bandwidth shall be less than or equal to the *Aggregated IAB-MT Channel Bandwidth*.

## 9.7.3 OTA Adjacent Channel Leakage Power Ratio (ACLR)

### 9.7.3.1 General

OTA Adjacent Channel Leakage power Ratio (ACLR) is the ratio of the filtered mean power centred on the assigned channel frequency to the filtered mean power centred on an adjacent channel frequency. The measured power is TRP.

The requirement shall be applied per RIB during the *transmitter ON period*.

NOTE: When the indicated IAB-MT transmission timing mode is set to 'Case6' as specified in 3GPP TS 38.213 [10], the power imbalance for simultaneous transmission between IAB-DU and IAB-MT under which the system can be operated is declared by manufacturer.

### 9.7.3.2 Minimum requirement for IAB-DU type 1-O and IAB-MT type 1-O

The ACLR (CACLR) absolute *basic limits* in table 6.6.3.2-2 + X, 6.6.3.2-5 + X (where and X = 9 dB for IAB-DU and X =  $10\log_{10}(N_{\text{TXU,OTApercell}})$  for IAB-MT) or the ACLR (CACLR) *basic limit* in table 6.6.3.2-1, 6.6.3.2-3 or 6.6.3.2-4, whichever is less stringent, shall apply.

For a RIB operating in multi-carrier or contiguous CA, the ACLR requirements in clause 6.6.3.2 shall apply to IAB-DU and IAB-MT channel bandwidths of the outermost carrier for the frequency ranges defined in table 6.6.3.2-1. For a RIB operating in *non-contiguous spectrum*, the ACLR requirement in clause 6.6.3.2 shall apply in *sub-block gaps* for the frequency ranges defined in table 6.6.3.2-3, while the CACLR requirement in clause 6.6.3.2 shall apply in *sub-block gaps* for the frequency ranges defined in table 6.6.3.2-4.

For a *multi-band RIB*, the ACLR requirement in clause 6.6.3.2 shall apply in *Inter RF Bandwidth gaps* for the frequency ranges defined in table 6.6.3.2-3, while the CACLR requirement in clause 6.6.3.2 shall apply in *Inter RF Bandwidth gaps* for the frequency ranges defined in table 6.6.3.2-4.

### 9.7.3.3 Minimum requirement for IAB-DU type 2-O and Wide Area IAB-MT type 2-O

The OTA ACLR limit is specified in table 9.7.3.3-1.

The OTA ACLR absolute limit is specified in table 9.7.3.3-2.

The OTA ACLR (CACLR) absolute limit in table 9.7.3.3-2 or 9.7.3.3-5 or the ACLR (CACLR) limit in table 9.7.3.3-1, 9.7.3.3-3 or 9.7.3.3-4, whichever is less stringent, shall apply.

For a RIB operating in multi-carrier or contiguous CA, the OTA ACLR requirements in table 9.7.3.3-1 shall apply to IAB-DU and IAB-MT channel bandwidths of the outermost carrier for the frequency ranges defined in the table. For a RIB operating in *non-contiguous spectrum*, the OTA ACLR requirement in table 9.7.3.3-3 shall apply in *sub-block gaps* for the frequency ranges defined in the table, while the OTA CACLR requirement in table 9.7.3.3-4 shall apply in *sub-block gaps* for the frequency ranges defined in the table.

The CACLR in a *sub-block gap* is the ratio of:

- the sum of the filtered mean power centred on the assigned channel frequencies for the two carriers adjacent to each side of the *sub-block gap*, and
- the filtered mean power centred on a frequency channel adjacent to one of the respective *sub-block* edges.

The assumed filter for the adjacent channel frequency is defined in table 9.7.3.3-4 and the filters on the assigned channels are defined in table 9.7.3.3-6.

For operation in *non-contiguous spectrum*, the CACLR for NR carriers located on either side of the *sub-block gap* shall be higher than the value specified in table 9.7.3.3-4.

**Table 9.7.3.3-1: IAB-DU type 2-O and Wide area IAB-MT type 2-O ACLR limit**

IAB-DU and IAB-MT channel bandwidth of lowest/highest carrier transmitted $BW_{\text{Channel}}$ (MHz)	IAB-DU and IAB-MT adjacent channel centre frequency offset below the lowest or above the highest carrier centre frequency transmitted	Assumed adjacent channel carrier	Filter on the adjacent channel frequency and corresponding filter bandwidth	ACLR limit (dB)
50, 100, 200, 400	$BW_{\text{Channel}}$	NR of same BW (Note 2)	Square ( $BW_{\text{Config}}$ )	28 (Note 3) 26 (Note 4)
NOTE 1: $BW_{\text{Channel}}$ and $BW_{\text{Config}}$ are the IAB-DU and IAB-MT channel bandwidth and transmission bandwidth configuration of the lowest/highest carrier transmitted on the assigned channel frequency.				
NOTE 2: With SCS that provides largest transmission bandwidth configuration ( $BW_{\text{Config}}$ ).				
NOTE 3: Applicable to bands defined within the frequency spectrum range of 24.25 – 33.4 GHz				
NOTE 4: Applicable to bands defined within the frequency spectrum range of 37 – 52.6 GHz				

Table 9.7.3.3-2: IAB-DU type 2-O and Wide area IAB-MT type 2-O ACLR absolute limit

IAB-DU and IAB-MT class	ACLR absolute limit
Wide area IAB-DU and Wide area IAB-MT	-13 dBm/MHz
Medium range IAB-DU	-20 dBm/MHz
Local area IAB-DU	-20 dBm/MHz

Table 9.7.3.3-3: IAB DU type 2-O and Wide Area IAB-MT type 2-O ACLR limit in non-contiguous spectrum

IAB-DU and IAB-MT channel bandwidth of lowest/highest carrier transmitted (MHz)	Sub-block gap size ( $W_{\text{gap}}$ ) where the limit applies (MHz)	IAB-DU and IAB-MT adjacent channel centre frequency offset below or above the sub-block edge (inside the gap)	Assumed adjacent channel carrier	Filter on the adjacent channel frequency and corresponding filter bandwidth	ACLR limit
50, 100	$W_{\text{gap}} \geq 100$ (Note 5) $W_{\text{gap}} \geq 250$ (Note 6)	25 MHz	50 MHz NR (Note 2)	Square ( $BW_{\text{Config}}$ )	28 (Note 3) 26 (Note 4)
200, 400	$W_{\text{gap}} \geq 400$ (Note 6) $W_{\text{gap}} \geq 250$ (Note 5)	100 MHz	200 MHz NR (Note 2)	Square ( $BW_{\text{Config}}$ )	28 (Note 3) 26 (Note 4)

NOTE 1:  $BW_{\text{Config}}$  is the transmission bandwidth configuration of the assumed adjacent channel carrier.  
NOTE 2: With SCS that provides largest transmission bandwidth configuration ( $BW_{\text{Config}}$ ).  
NOTE 3: Applicable to bands defined within the frequency spectrum range of 24.25 – 33.4 GHz.  
NOTE 4: Applicable to bands defined within the frequency spectrum range of 37 – 52.6 GHz.  
NOTE 5: Applicable in case the IAB-DU or IAB-MT channel bandwidth of the NR carrier transmitted at the other edge of the gap is 50 or 100 MHz.  
NOTE 6: Applicable in case the IAB-DU or IAB-MT channel bandwidth of the NR carrier transmitted at the other edge of the gap is 200 or 400 MHz.

Table 9.7.3.3-4: IAB DU type 2-O and Wide Area IAB-MT type 2-O CACLR limit in non-contiguous spectrum

IAB-DU and IAB-MT channel bandwidth of lowest/highest carrier transmitted (MHz)	Sub-block gap size ( $W_{\text{gap}}$ ) where the limit applies (MHz)	IAB-DU and IAB-MT adjacent channel centre frequency offset below or above the sub-block edge (inside the gap)	Assumed adjacent channel carrier	Filter on the adjacent channel frequency and corresponding filter bandwidth	CACLR limit
50, 100	$50 \leq W_{\text{gap}} < 100$ (Note 5) $50 \leq W_{\text{gap}} < 250$ (Note 6)	25 MHz	50 MHz NR (Note 2)	Square ( $BW_{\text{Config}}$ )	28 (Note 3) 26 (Note 4)
200, 400	$200 \leq W_{\text{gap}} < 400$ (Note 6) $200 \leq W_{\text{gap}} < 250$ (Note 5)	100 MHz	200 MHz NR (Note 2)	Square ( $BW_{\text{Config}}$ )	28 (Note 3) 26 (Note 4)

NOTE 1:  $BW_{\text{Config}}$  is the transmission bandwidth configuration of the assumed adjacent channel carrier.  
NOTE 2: With SCS that provides largest transmission bandwidth configuration ( $BW_{\text{Config}}$ ).  
NOTE 3: Applicable to bands defined within the frequency spectrum range of 24.25 – 33.4 GHz.  
NOTE 4: Applicable to bands defined within the frequency spectrum range of 37 – 52.6 GHz.  
NOTE 5: Applicable in case the IAB-DU or IAB-MT channel bandwidth of the NR carrier transmitted at the other edge of the gap is 50 or 100 MHz.  
NOTE 6: Applicable in case the IAB-DU or IAB-MT channel bandwidth of the NR carrier transmitted at the other edge of the gap is 200 or 400 MHz.

**Table 9.7.3.3-5: IAB-DU type 2-O and Wide area IAB-MT type 2-O CACLR absolute limit**

IAB-DU and IAB-MT class	CACLR absolute limit
Wide area IAB-DU and Wide area IAB-MT	-13 dBm/MHz
Medium range IAB-DU	-20 dBm/MHz
Local area IAB-DU	-20 dBm/MHz

**Table 9.7.3.3-6: Filter parameters for the assigned channel**

RAT of the carrier adjacent to the <i>sub-block gap</i>	Filter on the assigned channel frequency and corresponding filter bandwidth
NR	NR of same BW with SCS that provides largest <i>transmission bandwidth configuration</i>

### 9.7.3.4 Minimum requirement for *Local Area IAB-MT type 2-O*

The OTA ACLR limit is specified in table 9.7.3.4-1.

The OTA ACLR absolute limit is specified in table 9.7.3.4-2.

The OTA ACLR (CACLR) absolute limit in table 9.7.3.4-2 or 9.7.3.4-5 or the ACLR (CACLR) limit in table 9.7.3.4-1, 9.7.3.4-3 or 9.7.3.4-4, whichever is less stringent, shall apply.

Requirements specified for Local Area IAB-DU type 2-O in clause 9.7.3.3 shall apply to Local Area IAB-MT type 2-O during transmission in DL timeslot.

For a *RIB* operating in multi-carrier or contiguous CA, the OTA ACLR requirements in table 9.7.3.4-1 shall apply to *IAB-MT channel bandwidths* of the outermost carrier for the frequency ranges defined in the table. For a *RIB* operating in *non-contiguous spectrum*, the OTA ACLR requirement in table 9.7.3.4-3 shall apply in *sub-block gaps* for the frequency ranges defined in the table, while the OTA CACLR requirement in table 9.7.3.4-4 shall apply in *sub-block gaps* for the frequency ranges defined in the table.

The CACLR in a *sub-block gap* is the ratio of:

- the sum of the filtered mean power centred on the assigned channel frequencies for the two carriers adjacent to each side of the *sub-block gap*, and
- the filtered mean power centred on a frequency channel adjacent to one of the respective *sub-block* edges.

The assumed filter for the adjacent channel frequency is defined in table 9.7.3.4-4 and the filters on the assigned channels are defined in table 9.7.3.4-6.

For operation in *non-contiguous spectrum*, the CACLR for NR carriers located on either side of the *sub-block gap* shall be higher than the value specified in table 9.7.3.4-4.

**Table 9.7.3.4-1: Local Area IAB-MT type 2-O ACLR limit**

<i>IAB-MT channel bandwidth of lowest/highest carrier transmitted</i> $BW_{\text{Channel}}$ (MHz)	<i>IAB-MT adjacent channel centre frequency offset below the lowest or above the highest carrier centre frequency transmitted</i>	Assumed adjacent channel carrier	Filter on the adjacent channel frequency and corresponding filter bandwidth	ACLR limit (dB)
50, 100, 200, 400	$BW_{\text{Channel}}$	NR of same BW (Note 2)	Square ( $BW_{\text{Config}}$ )	24 (Note 3)
NOTE 1: $BW_{\text{Channel}}$ and $BW_{\text{Config}}$ are the <i>IAB-MT channel bandwidth</i> and <i>transmission bandwidth configuration</i> of the <i>lowest/highest carrier</i> transmitted on the assigned channel frequency.				
NOTE 2: With SCS that provides largest <i>transmission bandwidth configuration</i> ( $BW_{\text{Config}}$ ).				
NOTE 3: Applicable to bands defined within the frequency spectrum range of 24.25 – 33.4 GHz and 37 – 52.6 GHz				

Table 9.7.3.3-2: Local Area *IAB-MT* type 2-O ACLR absolute limit

IAB-MT class	ACLR absolute limit
Local area IAB-MT	-20 dBm/MHz

Table 9.7.3.3-3: Local Area *IAB-MT* type 2-O ACLR limit in non-contiguous spectrum

<i>IAB-MT</i> channel bandwidth of lowest/highest carrier transmitted (MHz)	Sub-block gap size ( $W_{\text{gap}}$ ) where the limit applies (MHz)	<i>IAB-MT</i> adjacent channel centre frequency offset below or above the sub-block edge (inside the gap)	Assumed adjacent channel carrier	Filter on the adjacent channel frequency and corresponding filter bandwidth	ACLR limit
50, 100	$W_{\text{gap}} \geq 100$ (Note 4) $W_{\text{gap}} \geq 250$ (Note 5)	25 MHz	50 MHz NR (Note 2)	Square ( $BW_{\text{Config}}$ )	24 (Note 3)
200, 400	$W_{\text{gap}} \geq 400$ (Note 5) $W_{\text{gap}} \geq 250$ (Note 4)	100 MHz	200 MHz NR (Note 2)	Square ( $BW_{\text{Config}}$ )	24 (Note 3)

NOTE 1:  $BW_{\text{Config}}$  is the *transmission bandwidth configuration* of the assumed adjacent channel carrier.  
NOTE 2: With SCS that provides largest *transmission bandwidth configuration* ( $BW_{\text{Config}}$ ).  
NOTE 3: Applicable to bands defined within the frequency spectrum range of 24.25 – 33.4 GHz and 37 – 52.6 GHz.  
NOTE 4: Applicable in case the *IAB-MT channel bandwidth* of the NR carrier transmitted at the other edge of the gap is 50 or 100 MHz.  
NOTE 5: Applicable in case the *IAB-MT channel bandwidth* of the NR carrier transmitted at the other edge of the gap is 200 or 400 MHz.

Table 9.7.3.3-4: Local Area *IAB-MT* type 2-O CACLR limit in non-contiguous spectrum

<i>IAB-MT</i> channel bandwidth of lowest/highest carrier transmitted (MHz)	Sub-block gap size ( $W_{\text{gap}}$ ) where the limit applies (MHz)	<i>IAB-MT</i> adjacent channel centre frequency offset below or above the sub-block edge (inside the gap)	Assumed adjacent channel carrier	Filter on the adjacent channel frequency and corresponding filter bandwidth	CACLR limit
50, 100	$50 \leq W_{\text{gap}} < 100$ (Note 4) $50 \leq W_{\text{gap}} < 250$ (Note 5)	25 MHz	50 MHz NR (Note 2)	Square ( $BW_{\text{Config}}$ )	24 (Note 3)
200, 400	$200 \leq W_{\text{gap}} < 400$ (Note 5) $200 \leq W_{\text{gap}} < 250$ (Note 4)	100 MHz	200 MHz NR (Note 2)	Square ( $BW_{\text{Config}}$ )	24 (Note 3)

NOTE 1:  $BW_{\text{Config}}$  is the *transmission bandwidth configuration* of the assumed adjacent channel carrier.  
NOTE 2: With SCS that provides largest *transmission bandwidth configuration* ( $BW_{\text{Config}}$ ).  
NOTE 3: Applicable to bands defined within the frequency spectrum range of 24.25 – 33.4 GHz.  
NOTE 4: Applicable in case the *IAB-MT channel bandwidth* of the NR carrier transmitted at the other edge of the gap is 50 or 100 MHz.  
NOTE 5: Applicable in case the *IAB-MT channel bandwidth* of the NR carrier transmitted at the other edge of the gap is 200 or 400 MHz.

Table 9.7.3.3-5: Local Area *IAB-MT* type 2-O CACLR absolute limit

IAB-MT class	CACLR absolute limit
Local area IAB-MT	-20 dBm/MHz



Table 9.7.3.3-6: Filter parameters for the assigned channel

RAT of the carrier adjacent to the <i>sub-block gap</i>	Filter on the assigned channel frequency and corresponding filter bandwidth
NR	NR of same BW with SCS that provides largest <i>transmission bandwidth configuration</i>

## 9.7.4 OTA operating band unwanted emissions

### 9.7.4.1 General

The OTA limits for operating band unwanted emissions are specified as TRP per RIB unless otherwise stated.

### 9.7.4.2 Minimum requirement for *IAB-DU type 1-O*

Out-of-band emissions in FR1 are limited by OTA operating band unwanted emission limits. Unless otherwise stated, the operating band unwanted emission limits in FR1 are defined from  $\Delta f_{\text{OBUE}}$  below the lowest frequency of each supported downlink *operating band* up to  $\Delta f_{\text{OBUE}}$  above the highest frequency of each supported downlink *operating band*. The values of  $\Delta f_{\text{OBUE}}$  are defined in table 9.7.1-1 for the NR *operating bands*.

The requirements shall apply whatever the type of transmitter considered and for all transmission modes foreseen by the manufacturer's specification. For a *RIB* operating in multi-carrier or contiguous CA, the requirements apply to *IAB-DU channel bandwidths* of the outermost carrier for the frequency ranges defined in clause 6.6.4.1.

For a *RIB* operating in *non-contiguous spectrum*, the requirements shall apply inside any *sub-block gap* for the frequency ranges defined in clause 6.6.4.1.

For a *multi-band RIB*, the requirements shall apply inside any *Inter RF Bandwidth gap* for the frequency ranges defined in clause 6.6.4.1.

The OTA operating band unwanted emission requirement for *IAB-DU type 1-O* is that for each applicable *basic limit* in clause 6.6.4.2, the power of any unwanted emission shall not exceed an OTA limit specified as the *basic limit* + X, where X = 9 dB.

### 9.7.4.3 Minimum requirement for *IAB-MT type 1-O*

Out-of-band emissions in FR1 are limited by OTA operating band unwanted emission limits. Unless otherwise stated, the operating band unwanted emission limits in FR1 are defined from  $\Delta f_{\text{OBUE}}$  below the lowest frequency of each supported uplink *operating band* up to  $\Delta f_{\text{OBUE}}$  above the highest frequency of each supported uplink *operating band*. The values of  $\Delta f_{\text{OBUE}}$  are defined in table 9.7.1-2 for the NR *operating bands*.

The requirements shall apply whatever the type of transmitter considered and for all transmission modes foreseen by the manufacturer's specification. For a *RIB* operating in multi-carrier or contiguous CA, the requirements apply to *IAB-MT channel bandwidths* of the outermost carrier for the frequency ranges defined in clause 6.6.4.1.

For a *RIB* operating in *non-contiguous spectrum*, the requirements shall apply inside any *sub-block gap* for the frequency ranges defined in clause 6.6.4.1.

For a *multi-band RIB*, the requirements shall apply inside any *Inter RF Bandwidth gap* for the frequency ranges defined in clause 6.6.4.1.

The OTA operating band unwanted emission requirement for *IAB-MT type 1-O* is that for each applicable *basic limit* in clause 6.6.4.2, the power of any unwanted emission shall not exceed an OTA limit specified as the *basic limit* + X, where X =  $10\log_{10}(N_{\text{TXU,OTApercell}})$  dB.

### 9.7.4.4 Additional requirements

#### 9.7.4.4.1 Limits in FCC Title 47

The IAB-DU and IAB-MT may have to comply with the applicable emission limits established by FCC Title 47 [20], when deployed in regions where those limits are applied, and under the conditions declared by the manufacturer.

## 9.7.4.5 Minimum requirement for *IAB-DU type 2-O* and *IAB-MT type 2-O*

### 9.7.4.5.1 General

The requirements of either clause 9.7.4.5.2 (Category A limits) or clause 9.7.4.5.3 (Category B limits) shall apply. The application of either Category A or Category B limits shall be the same as for General OTA transmitter spurious emissions requirements (*IAB-DU and IAB-MT type 2-O*) in clause 9.7.6.3.2. In addition, the limits in clause 9.7.4.5.4 may also apply.

Out-of-band emissions in FR2-1 are limited by OTA operating band unwanted emission limits.

For *IAB-DU type 2-O*, unless otherwise stated, the OTA operating band unwanted emission limits in FR2-1 are defined from  $\Delta f_{\text{OBUE}}$  below the lowest frequency of each supported downlink *operating band* up to  $\Delta f_{\text{OBUE}}$  above the highest frequency of each supported downlink *operating band*.

For *IAB-MT type 2-O*, unless otherwise stated, the OTA operating band unwanted emission limits in FR2-1 are defined from  $\Delta f_{\text{OBUE}}$  below the lowest frequency of each supported uplink *operating band* up to  $\Delta f_{\text{OBUE}}$  above the highest frequency of each supported uplink *operating band*.

The values of  $\Delta f_{\text{OBUE}}$  are defined in table 9.7.1-1 and 9.7.1-2 for the NR *operating bands*.

The requirements shall apply whatever the type of transmitter considered and for all transmission modes foreseen by the manufacturer's specification. For a *RIB* operating in multi-carrier or contiguous *CA*, the requirements apply to the frequencies ( $\Delta f_{\text{OBUE}}$ ) starting from the edge of the *contiguous transmission bandwidth*. In addition, for a *RIB* operating in *non-contiguous spectrum*, the requirements apply inside any *sub-block gap*.

Emissions shall not exceed the maximum levels specified in the tables below, where:

- $\Delta f$  is the separation between the *contiguous transmission bandwidth* edge frequency and the nominal -3dB point of the measuring filter closest to the *contiguous transmission bandwidth* edge.
- $f_{\text{offset}}$  is the separation between the *contiguous transmission bandwidth* edge frequency and the centre of the measuring filter.
- $f_{\text{offset}_{\text{max}}}$  is the offset to the frequency  $\Delta f_{\text{OBUE}}$  outside the downlink *operating band*, where  $\Delta f_{\text{OBUE}}$  is defined in table 9.7.1-1.
- $\Delta f_{\text{max}}$  is equal to  $f_{\text{offset}_{\text{max}}}$  minus half of the bandwidth of the measuring filter.

In addition, inside any *sub-block gap* for a *RIB* operating in *non-contiguous spectrum*, emissions shall not exceed the cumulative sum of the limits specified for the adjacent *sub-blocks* on each side of the *sub-block gap*. The limit for each *sub-block* is specified in clauses 9.7.4.5.2 and 9.7.4.5.3 below, where in this case:

- $\Delta f$  is the separation between the *sub-block* edge frequency and the nominal -3 dB point of the measuring filter closest to the *sub-block* edge.
- $f_{\text{offset}}$  is the separation between the *sub-block* edge frequency and the centre of the measuring filter.
- $f_{\text{offset}_{\text{max}}}$  is equal to the *sub-block gap* bandwidth minus half of the bandwidth of the measuring filter.
- $\Delta f_{\text{max}}$  is equal to  $f_{\text{offset}_{\text{max}}}$  minus half of the bandwidth of the measuring filter.

## 9.7.4.5.2 OTA operating band unwanted emission limits (Category A)

IAB-DU and IAB-MT unwanted emissions shall not exceed the maximum levels specified in table 9.7.4.3.2-1 and 9.7.4.3.2-2.

Table 9.7.4.5.2-1: OBUE limits applicable in the frequency range 24.25 – 33.4 GHz

Frequency offset of measurement filter -3B point, $\Delta f$	Frequency offset of measurement filter centre frequency, $f_{\text{offset}}$	Limit	Measurement bandwidth
$0 \text{ MHz} \leq \Delta f < 0.1 * \text{BW}_{\text{contiguous}}$	$0.5 \text{ MHz} \leq f_{\text{offset}} < 0.1 * \text{BW}_{\text{contiguous}} + 0.5 \text{ MHz}$	Min(-5 dBm, Max( $P_{\text{rated,t,TRP}} - 35 \text{ dB}$ , -12 dBm))	1 MHz
$0.1 * \text{BW}_{\text{contiguous}} \leq \Delta f < \Delta f_{\text{max}}$	$0.1 * \text{BW}_{\text{contiguous}} + 0.5 \text{ MHz} \leq f_{\text{offset}} < f_{\text{offset}_{\text{max}}}$	Min(-13 dBm, Max( $P_{\text{rated,t,TRP}} - 43 \text{ dB}$ , -20 dBm))	1 MHz
NOTE 1: For <i>non-contiguous spectrum</i> operation within any <i>operating band</i> the limit within <i>sub-block gaps</i> is calculated as a cumulative sum of contributions from adjacent <i>sub-blocks</i> on each side of the <i>sub-block gap</i> .			

Table 9.7.4.5.2-2: OBUE limits applicable in the frequency range 37 – 52.6 GHz

Frequency offset of measurement filter -3B point, $\Delta f$	Frequency offset of measurement filter centre frequency, $f_{\text{offset}}$	Limit	Measurement bandwidth
$0 \text{ MHz} \leq \Delta f < 0.1 * \text{BW}_{\text{contiguous}}$	$0.5 \text{ MHz} \leq f_{\text{offset}} < 0.1 * \text{BW}_{\text{contiguous}} + 0.5 \text{ MHz}$	Min(-5 dBm, Max( $P_{\text{rated,t,TRP}} - 33 \text{ dB}$ , -12 dBm))	1 MHz
$0.1 * \text{BW}_{\text{contiguous}} \leq \Delta f < \Delta f_{\text{max}}$	$0.1 * \text{BW}_{\text{contiguous}} + 0.5 \text{ MHz} \leq f_{\text{offset}} < f_{\text{offset}_{\text{max}}}$	Min(-13 dBm, Max( $P_{\text{rated,t,TRP}} - 41 \text{ dB}$ , -20 dBm))	1 MHz
NOTE 1: For <i>non-contiguous spectrum</i> operation within any <i>operating band</i> the limit within <i>sub-block gaps</i> is calculated as a cumulative sum of contributions from adjacent <i>sub-blocks</i> on each side of the <i>sub-block gap</i> .			

## 9.7.4.5.3 OTA operating band unwanted emission limits (Category B)

IAB-DU and IAB-MT unwanted emissions shall not exceed the maximum levels specified in table 9.7.4.5.3-1 or 9.7.4.5.3-2.

Table 9.7.4.5.3-1: OBUE limits applicable in the frequency range 24.25 – 33.4 GHz

Frequency offset of measurement filter -3 dB point, $\Delta f$	Frequency offset of measurement filter centre frequency, $f_{\text{offset}}$	Limit	Measurement bandwidth
$0 \text{ MHz} \leq \Delta f < 0.1 * \text{BW}_{\text{contiguous}}$	$0.5 \text{ MHz} \leq f_{\text{offset}} < 0.1 * \text{BW}_{\text{contiguous}} + 0.5 \text{ MHz}$	Min(-5 dBm, Max( $P_{\text{rated,t,TRP}} - 35 \text{ dB}$ , -12 dBm))	1 MHz
$0.1 * \text{BW}_{\text{contiguous}} \leq \Delta f < \Delta f_{\text{B}}$	$0.1 * \text{BW}_{\text{contiguous}} + 0.5 \text{ MHz} \leq f_{\text{offset}} < \Delta f_{\text{B}} + 0.5 \text{ MHz}$	Min(-13 dBm, Max( $P_{\text{rated,t,TRP}} - 43 \text{ dB}$ , -20 dBm))	1 MHz
$\Delta f_{\text{B}} \leq \Delta f < \Delta f_{\text{max}}$	$\Delta f_{\text{B}} + 5 \text{ MHz} \leq f_{\text{offset}} < f_{\text{offset}_{\text{max}}}$	Min(-5 dBm, Max( $P_{\text{rated,t,TRP}} - 33 \text{ dB}$ , -10 dBm))	10 MHz
NOTE 1: For non-contiguous spectrum operation within any <i>operating band</i> the limit within sub-block gaps is calculated as a cumulative sum of contributions from adjacent sub-blocks on each side of the sub-block gap.			
NOTE 2: $\Delta f_{\text{B}} = 2 * \text{BW}_{\text{contiguous}}$ when $\text{BW}_{\text{contiguous}} \leq 500 \text{ MHz}$ , otherwise $\Delta f_{\text{B}} = \text{BW}_{\text{contiguous}} + 500 \text{ MHz}$ .			

**Table 9.7.4.5.3-2: OBUE limits applicable in the frequency range 37 – 52.6 GHz**

Frequency offset of measurement filter -3 dB point, $\Delta f$	Frequency offset of measurement filter centre frequency, $f_{\text{offset}}$	Limit	Measurement bandwidth
$0 \text{ MHz} \leq \Delta f < 0.1 * BW_{\text{contiguous}}$	$0.5 \text{ MHz} \leq f_{\text{offset}} < 0.1 * BW_{\text{contiguous}} + 0.5 \text{ MHz}$	Min(-5 dBm, Max( $P_{\text{rated,t,TRP}} - 33 \text{ dB}$ , -12 dBm))	1 MHz
$0.1 * BW_{\text{contiguous}} \leq \Delta f < \Delta f_{\text{B}}$	$0.1 * BW_{\text{contiguous}} + 0.5 \text{ MHz} \leq f_{\text{offset}} < \Delta f_{\text{B}} + 0.5 \text{ MHz}$	Min(-13 dBm, Max( $P_{\text{rated,t,TRP}} - 41 \text{ dB}$ , -20 dBm))	1 MHz
$\Delta f_{\text{B}} \leq \Delta f < \Delta f_{\text{max}}$	$\Delta f_{\text{B}} + 5 \text{ MHz} \leq f_{\text{offset}} < f_{\text{offset}_{\text{max}}}$	Min(-5 dBm, Max( $P_{\text{rated,t,TRP}} - 31 \text{ dB}$ , -10 dBm))	10 MHz
NOTE 1: For non-contiguous spectrum operation within any <i>operating band</i> the limit within sub-block gaps is calculated as a cumulative sum of contributions from adjacent sub-blocks on each side of the sub-block gap.			
NOTE 2: $\Delta f_{\text{B}} = 2 * BW_{\text{contiguous}}$ when $BW_{\text{contiguous}} \leq 500 \text{ MHz}$ , otherwise $\Delta f_{\text{B}} = BW_{\text{contiguous}} + 500 \text{ MHz}$ .			

#### 9.7.4.5.4 Additional OTA operating band unwanted emission requirements

##### 9.7.4.5.4.1 Protection of Earth Exploration Satellite Service

For IAB-DU and IAB-MT operating in the frequency range 24.25 – 27.5 GHz, the power of unwanted emission shall not exceed the limits in table 9.7.4.5.4.1-1.

**Table 9.7.4.5.4.1-1: OBUE limits for protection of Earth Exploration Satellite Service**

Frequency range	Limit	Measurement Bandwidth
23.6 – 24 GHz	-3 dBm (Note 1)	200 MHz
23.6 – 24 GHz	-9 dBm (Note 2)	200 MHz
NOTE 1: This limit applies to IAB-DU and IAB-MT brought into use on or before 1 September 2027 and enters into force from January 1, 2021.		
NOTE 2: This limit applies to IAB-DU and IAB-MT brought into use after 1 September 2027.		

## 9.7.5 OTA transmitter spurious emissions

### 9.7.5.1 General

Unless otherwise stated, all requirements are measured as mean power.

The OTA spurious emissions limits are specified as TRP per RIB unless otherwise stated.

### 9.7.5.2 Minimum requirement for *IAB-DU type 1-0* and *IAB-MT type 1-0*

#### 9.7.5.2.1 General

For IAB-DU, the OTA transmitter spurious emission limits for FR1 shall apply from 30 MHz to 12.75 GHz, excluding the frequency range from  $\Delta f_{\text{OBUE}}$  below the lowest frequency of each supported downlink *operating band*, up to  $\Delta f_{\text{OBUE}}$  above the highest frequency of each supported downlink *operating band*, where the  $\Delta f_{\text{OBUE}}$  is defined in table 9.7.1-1. For some FR1 *operating bands*, the upper limit is higher than 12.75 GHz in order to comply with the 5<sup>th</sup> harmonic limit of the downlink *operating band*, as specified in ITU-R recommendation SM.329 [16].

For IAB-MT, the OTA transmitter spurious emission limits for FR1 shall apply from 30 MHz to 12.75 GHz, excluding the frequency range from  $\Delta f_{\text{OBUE}}$  below the lowest frequency of each supported uplink *operating band*, up to  $\Delta f_{\text{OBUE}}$  above the highest frequency of each supported uplink *operating band*, where the  $\Delta f_{\text{OBUE}}$  is defined in table 9.7.1-2. For some FR1 *operating bands*, the upper limit is higher than 12.75 GHz in order to comply with the 5<sup>th</sup> harmonic limit of the uplink *operating band*, as specified in ITU-R recommendation SM.329 [16].

For *multi-band RIB* each supported *operating band* and  $\Delta f_{\text{OBUE}}$  MHz around each band are excluded from the OTA transmitter spurious emissions requirements.

The requirements shall apply whatever the type of transmitter considered (single carrier or multi-carrier). It applies for all transmission modes foreseen by the manufacturer's specification.

*IAB-DU type 1-O* and *IAB-MT type 1-O* requirements consist of OTA transmitter spurious emission requirements based on TRP and co-location requirements not based on TRP.

### 9.7.5.2.2 General OTA transmitter spurious emissions requirements

The Tx spurious emissions requirements for *IAB-DU type 1-O* are that for each applicable *basic limit* above 30 MHz in clause 6.6.5.2.1, the TRP of any spurious emission shall not exceed an OTA limit specified as the *basic limit* + X, where X = 9 dB, unless stated differently in regional regulation.

The Tx spurious emissions requirements for *IAB-MT type 1-O* are that for each applicable *basic limit* above 30 MHz in clause 6.6.5.2.1, the TRP of any spurious emission shall not exceed an OTA limit specified as the *basic limit* + X, where X =  $10\log_{10}(N_{\text{TXU,OTApercell}})$  dB, unless stated differently in regional regulation.

### 9.7.5.2.3 Additional spurious emissions requirements

These requirements may be applied for the protection of systems operating in frequency ranges other than *IAB-DU* downlink *operating band* or *IAB-MT* uplink *operating band*. The limits may apply as an optional protection of such systems that are deployed in the same geographical area as the *IAB-Node*, or they may be set by local or regional regulation as a mandatory requirement for an NR *operating band*. It is in some cases not stated in the present document whether a requirement is mandatory or under what exact circumstances that a limit applies, since this is set by local or regional regulation. An overview of regional requirements in the present document is given in clause 4.5.

Some requirements may apply for the protection of specific equipment (UE, MS and/or BS) or equipment operating in specific systems (GSM, CDMA, UTRA, E-UTRA, NR, etc.). The Tx additional spurious emissions requirements for *IAB-DU type 1-O* and *IAB-MT type 1-O* are that for each applicable *basic limit* in clause 6.6.5.2.2, the TRP of any spurious emission shall not exceed an OTA limit specified as the *basic limit* + X, where X = 9 dB for *IAB-DU* and X =  $10\log_{10}(N_{\text{TXU,OTApercell}})$  dB for *IAB-MT*.

### 9.7.5.2.4 Co-location with other base stations and IAB-Nodes

These requirements may be applied for the protection of other receivers when GSM900, DCS1800, PCS1900, GSM850, CDMA850, UTRA FDD, UTRA TDD, E-UTRA, NR BS, *IAB-DU* and/or *IAB-MT* are co-located with an *IAB-Node*.

The requirements assume co-location with the same class.

NOTE: For co-location with UTRA, the requirements are based on co-location with UTRA FDD or TDD base stations.

This requirement is a co-location requirement as defined in clause 4.9, the power levels are specified at the *co-location reference antenna* output(s).

The power sum of any spurious emission is specified over all supported polarizations at the output(s) of the *co-location reference antenna* and shall not exceed the *basic limits* in clause 6.6.5.2.3 + X dB, where X = -21 dB for *IAB-DU* and X =  $-30 + 10\log_{10}(N_{\text{TXU,OTApercell}})$  dB for *IAB-MT*.

For a *multi-band RIB*, the exclusions and conditions in the notes column of table 6.6.5.2.3-1 apply for each supported *operating band*.

## 9.7.5.3 Minimum requirement for *IAB-DU type 2-O* and *IAB-MT type 2-O*

### 9.7.5.3.1 General

For *IAB-DU type 2-O*, the OTA transmitter spurious emission limits apply from 30 MHz to 2<sup>nd</sup> harmonic of the upper frequency edge of the downlink *operating band*, excluding the frequency range from  $\Delta f_{\text{OBUE}}$  below the lowest frequency of the downlink *operating band*, up to  $\Delta f_{\text{OBUE}}$  above the highest frequency of the downlink *operating band*, where the  $\Delta f_{\text{OBUE}}$  is defined in table 9.7.1-1.

For IAB-MT type 2-O, the OTA transmitter spurious emission limits apply from 30 MHz to 2<sup>nd</sup> harmonic of the upper frequency edge of the downlink *operating band*, excluding the frequency range from  $\Delta f_{\text{OBUE}}$  below the lowest frequency of the uplink *operating band*, up to  $\Delta f_{\text{OBUE}}$  above the highest frequency of the uplink *operating band*, where the  $\Delta f_{\text{OBUE}}$  is defined in table 9.7.1-2.

### 9.7.5.3.2 General OTA transmitter spurious emissions requirements

#### 9.7.5.3.2.1 General

The requirements of either clause 9.7.5.3.2.2 (Category A limits) or clause 9.7.5.3.2.3 (Category B limits) shall apply. The application of either Category A or Category B limits shall be the same as for Operating band unwanted emissions in clause 9.7.4.

#### 9.7.5.3.2.2 OTA transmitter spurious emissions (Category A)

The power of any spurious emission shall not exceed the limits in table 9.7.5.3.2-1

**Table 9.7.5.3.2.2-1: IAB-DU and IAB-MT radiated Tx spurious emission limits in FR2-1**

Frequency range	Limit	Measurement Bandwidth	Note
30 MHz – 1 GHz	-13 dBm	100 kHz	Note 1
1 GHz – 2 <sup>nd</sup> harmonic of the upper frequency edge of the DL <i>operating band</i>		1 MHz	Note 1, Note 2
NOTE 1: Bandwidth as in ITU-R SM.329 [16], s4.1			
NOTE 2: Upper frequency as in ITU-R SM.329 [16], s2.5 table 1.			

#### 9.7.5.3.2.3 OTA transmitter spurious emissions (Category B)

The power of any spurious emission shall not exceed the limits in table 9.7.5.3.2.3-1.

**Table 9.7.5.3.2.3-1: IAB-DU and IAB-MT radiated Tx spurious emission limits in FR2-1 (Category B)**

Frequency range (Note 4)	Limit	Measurement Bandwidth	Note
30 MHz ↔ 1 GHz	-36 dBm	100 kHz	Note 1
1 GHz ↔ 18 GHz	-30 dBm	1 MHz	Note 1
18 GHz ↔ $F_{\text{step},1}$	-20 dBm	10 MHz	Note 2
$F_{\text{step},1}$ ↔ $F_{\text{step},2}$	-15 dBm	10 MHz	Note 2
$F_{\text{step},2}$ ↔ $F_{\text{step},3}$	-10 dBm	10 MHz	Note 2
$F_{\text{step},4}$ ↔ $F_{\text{step},5}$	-10 dBm	10 MHz	Note 2
$F_{\text{step},5}$ ↔ $F_{\text{step},6}$	-15 dBm	10 MHz	Note 2
$F_{\text{step},6}$ ↔ 2 <sup>nd</sup> harmonic of the upper frequency edge of the DL <i>operating band</i>	-20 dBm	10 MHz	Note 2, Note 3
NOTE 1: Bandwidth as in ITU-R SM.329 [16], s4.1			
NOTE 2: Limit and bandwidth as in ERC Recommendation 74-01 [19], Annex 2.			
NOTE 3: Upper frequency as in ITU-R SM.329 [16], s2.5 table 1.			
NOTE 4: The step frequencies $F_{\text{step},X}$ are defined in Table 9.7.5.3.2.3-2.			

**Table 9.7.5.3.2.3-2: Step frequencies for defining the IAB-DU and IAB-MT radiated Tx spurious emission limits in FR2-1 (Category B)**

Operating band	F <sub>step,1</sub> (GHz)	F <sub>step,2</sub> (GHz)	F <sub>step,3</sub> (GHz) (Note 2)	F <sub>step,4</sub> (GHz) (Note 2)	F <sub>step,5</sub> (GHz)	F <sub>step,6</sub> (GHz)
n258	18	21	22.75	29	30.75	40.5
n259	23.5	35.5	38	45	47.5	59.5

NOTE 1: F<sub>step,X</sub> are based on ERC Recommendation 74-01 [19], Annex 2.  
NOTE 2: F<sub>step,3</sub> and F<sub>step,4</sub> are aligned with the values for Δf<sub>OBUE</sub> in Table 9.7.1-1 and Table 9.7.1-2.

### 9.7.5.3.3 Additional OTA transmitter spurious emissions requirements

These requirements may be applied for the protection of systems operating in frequency ranges other than the IAB-Node. The limits may apply as an optional protection of such systems that are deployed in the same geographical area as the IAB-Node, or they may be set by local or regional regulation as a mandatory requirement for an NR operating band. It is in some cases not stated in the present document whether a requirement is mandatory or under what exact circumstances that a limit applies, since this is set by local or regional regulation. An overview of regional requirements in the present document is given in clause 4.5.

#### 9.7.5.3.3.1 Limits for protection of Earth Exploration Satellite Service

For IAB-DU and IAB-MT operating in the frequency range 24.25 – 27.5 GHz, the power of any spurious emissions shall not exceed the limits in Table 9.7.5.3.3.1-1.

**Table 9.7.5.3.3.1-1: Limits for protection of Earth Exploration Satellite Service**

Frequency range	Limit	Measurement Bandwidth	Note
23.6 – 24 GHz	-3 dBm	200 MHz	Note 1
23.6 – 24 GHz	-9 dBm	200 MHz	Note 2

NOTE 1: This limit applies to IAB-DU and IAB-MT brought into use on or before 1 September 2027 and enters into force from January 1, 2021.  
NOTE 2: This limit applies to IAB-DU and IAB-MT brought into use after 1 September 2027.

## 9.8 OTA transmitter intermodulation

### 9.8.1 General

The OTA transmitter intermodulation requirement is a measure of the capability of the transmitter unit to inhibit the generation of signals in its non-linear elements caused by presence of the wanted signal and an interfering signal reaching the transmitter unit via the RDN and antenna array from a co-located base station or IAB. The requirement applies during the *transmitter ON period* and the *transmitter transient period*.

The requirement shall apply at each RIB supporting transmission in the *operating band*.

The transmitter intermodulation level is the *total radiated power* of the intermodulation products when an interfering signal is injected into the *co-location reference antenna*.

The OTA transmitter intermodulation requirement is not applicable for *IAB type 2-O*.

### 9.8.2 Minimum requirement for *IAB-DU type 1-O* and *IAB-MT type 1-O*

For *IAB type 1-O* the transmitter intermodulation level shall not exceed the TRP unwanted emission limits specified for OTA transmitter spurious emission in clause 9.7.5.2 (except clause 9.7.5.2.3), OTA operating band unwanted emissions in clauses 9.7.4.2 and 9.7.4.3, and OTA ACLR in clause 9.7.3.2 in the presence of a wanted signal and an interfering signal, defined in table 9.8.2-1.

The requirement is applicable outside the *IAB RF Bandwidth edges*. The interfering signal offset is defined relative to the *IAB RF Bandwidth edges* or *Radio Bandwidth edges*.

For RIBs supporting operation in *non-contiguous spectrum*, the requirement is also applicable inside a *sub-block gap* for interfering signal offsets where the interfering signal falls completely within the *sub-block gap*. The interfering signal offset is defined relative to the *sub-block edges*.

For RIBs supporting operation in multiple *operating bands*, the requirement shall apply relative to the *IAB RF Bandwidth edges* of each *operating band*. In case the *inter RF Bandwidth gap* is less than  $3 \cdot BW_{\text{Channel}}$  (where  $BW_{\text{Channel}}$  is the minimal *IAB-DU Channel Bandwidth* or *IAB-MT Channel Bandwidth* of the band), the requirement in the gap shall apply only for interfering signal offsets where the interfering signal falls completely within the *inter RF Bandwidth gap*.

**Table 9.8. 2-1: Interfering and wanted signals for the OTA transmitter intermodulation requirement**

Parameter	Value
Wanted signal	NR signal or multi-carrier, or multiple intra-band contiguously or non-contiguously aggregated carriers
Interfering signal type	NR signal the minimum <i>IAB-DU Channel Bandwidth</i> ( $BW_{\text{Channel}}$ ) with or <i>IAB-MT Channel Bandwidth</i> ( $BW_{\text{Channel}}$ ) 15 kHz SCS of the band defined in clause 5.3.5
Interfering signal level	The interfering signal level is the same power level as the IAB ( $P_{\text{rated,t,TRP}}$ ) fed into a <i>co-location reference antenna</i> .
Interfering signal centre frequency offset from the lower (upper) edge of the wanted signal or edge of <i>sub-block</i> inside a gap	$f_{\text{offset}} = \pm BW_{\text{Channel}} \left( n - \frac{1}{2} \right)$ , for $n=1, 2$ and $3$
NOTE 1: Interfering signal positions that are partially or completely outside of any downlink <i>operating band</i> of the RIB are excluded from the requirement, unless the interfering signal positions fall within the frequency range of adjacent downlink <i>operating bands</i> in the same geographical area.	
NOTE 2: In Japan, NOTE 1 is not applied in Band n77, n78, n79.	
NOTE 3: The $P_{\text{rated,t,TRP}}$ is split between polarizations at the <i>co-location reference antenna</i> .	

## 10 Radiated receiver characteristics

### 10.1 General

Radiated receiver characteristics are specified at RIB for *IAB type 1-H*, *IAB type 1-O*, or *IAB type 2-O*, with full complement of transceivers for the configuration in normal operating condition.

Unless otherwise stated, the following arrangements apply for the radiated receiver characteristics requirements in clause 10:

- Requirements apply during the IAB receive period.
- Requirements shall be met for any transmitter setting.
- Throughput requirements defined for the radiated receiver characteristics do not assume HARQ retransmissions.
- When IAB is configured to receive multiple carriers, all the throughput requirements are applicable for each received carrier.
- For ACS, blocking and intermodulation characteristics, the negative offsets of the interfering signal apply relative to the lower *IAB RF Bandwidth edge* or *sub-block edge* inside a *sub-block gap*, and the positive offsets of the interfering signal apply relative to the upper *IAB RF Bandwidth edge* or *sub-block edge* inside a *sub-block gap*.
- Each requirement shall be met over the RoAoA specified.

NOTE 2: In normal operating condition the IAB in TDD operation is configured to TX OFF power during *receive period*.



For FR1 requirements which are to be met over the *OTA REFSENS RoAoA* absolute requirement values are offset by the following term:

$$\Delta_{\text{OTAREFSENS}} = 44.1 - 10 \cdot \log_{10}(\text{BeW}_{\theta, \text{REFSENS}} \cdot \text{BeW}_{\varphi, \text{REFSENS}}) \text{ dB for the reference direction}$$

and

$$\Delta_{\text{OTAREFSENS}} = 41.1 - 10 \cdot \log_{10}(\text{BeW}_{\theta, \text{REFSENS}} \cdot \text{BeW}_{\varphi, \text{REFSENS}}) \text{ dB for all other directions}$$

For requirements which are to be met over the *minSENS RoAoA* absolute requirement values are offset by the following term:

$$\Delta_{\text{minSENS}} = P_{\text{REFSENS}} - \text{EIS}_{\text{minSENS}} \text{ (dB)}$$

For FR2-1 requirements which are to be met over the *OTA REFSENS RoAoA* absolute requirement values are offset by the following term:

$$\Delta_{\text{FR2\_REFSENS}} = -3 \text{ dB for the reference direction}$$

and

$$\Delta_{\text{FR2\_REFSENS}} = 0 \text{ dB for all other directions}$$

## 10.2 OTA sensitivity

### 10.2.1 IAB-DU OTA sensitivity

#### 10.2.1.1 IAB-DU type 1-H and IAB-DU type 1-O

The OTA sensitivity requirement is a *directional requirement* based upon the declaration of one or more *OTA sensitivity directions declaration* (OSDD), related to a *IAB-DU type 1-H* and *IAB-DU type 1-O* receiver.

The IAB-DU reference sensitivity level is specified the same as the BS reference sensitivity level requirement for BS in TS 38.104 [2], subclause 10.2.1, where references to *BS channel bandwidth* apply to *IAB-DU channel bandwidth*.

#### 10.2.1.2 IAB-DU type 2-O

There is no OTA sensitivity requirement for FR2-1, the OTA sensitivity is the same as the OTA reference sensitivity in clause 10.3.

### 10.2.2 IAB-MT OTA sensitivity

#### 10.2.2.1 IAB-MT type 1-H and IAB-MT type 1-O

##### 10.2.2.1.1 General

The OTA sensitivity requirement is a *directional requirement* based upon the declaration of one or more *OTA sensitivity directions declaration* (OSDD), related to a *IAB-MT type 1-H* and *IAB-MT type 1-O* receiver.

The *IAB-MT type 1-H* and *IAB-MT type 1-O* may optionally be capable of redirecting/changing the *receiver target* by means of adjusting IAB-MT settings resulting in multiple *sensitivity RoAoA*. The *sensitivity RoAoA* resulting from the current IAB-MT settings is the active *sensitivity RoAoA*.

If the IAB-MT is capable of redirecting the *receiver target* related to the OSDD then the OSDD shall include:

- *IAB-MT channel bandwidth* and declared minimum EIS level applicable to any active *sensitivity RoAoA* inside the *receiver target redirection range* in the OSDD.

- A declared *receiver target redirection range*, describing all the angles of arrival that can be addressed for the OSDD through alternative settings in the IAB-MT.
- Five declared *sensitivity RoAoA* comprising the conformance testing directions as detailed in TS 38.141-2 [21].
- The *receiver target reference direction*.

NOTE 1: Some of the declared *sensitivity RoAoA* may coincide depending on the redirection capability.

NOTE 2: In addition to the declared *sensitivity RoAoA*, several *sensitivity RoAoA* may be implicitly defined by the *receiver target redirection range* without being explicitly declared in the OSDD.

If the IAB-MT is not capable of redirecting the *receiver target* related to the OSDD, then the OSDD includes only:

- The set(s) of RAT, *IAB-MT channel bandwidth* and declared minimum EIS level applicable to the *sensitivity RoAoA* in the OSDD.
- One declared active *sensitivity RoAoA*.
- The *receiver target reference direction*.

NOTE 4: For IAB-MT without target redirection capability, the declared (fixed) *sensitivity RoAoA* is always the active *sensitivity RoAoA*.

The OTA sensitivity EIS level declaration shall apply to each supported polarization, under the assumption of *polarization match*.

#### 10.2.2.1.2 Minimum requirement

For a received signal whose AoA of the incident wave is within the active *sensitivity RoAoA* of an OSDD, the error rate criterion as described in clause 7.2.2 shall be met when the level of the arriving signal is equal to the minimum EIS level in the respective declared set of EIS level and *IAB-MT channel bandwidth*.

#### 10.2.2.2 IAB-MT type 2-O

There is no OTA sensitivity requirement for FR2-1, the OTA sensitivity is the same as the OTA reference sensitivity in clause 10.3

## 10.3 OTA reference sensitivity level

### 10.3.1 General

The OTA REFSENS requirement is a *directional requirement* and is intended to ensure the minimum OTA reference sensitivity level for a declared *OTA REFSENS RoAoA*. The OTA reference sensitivity power level  $EIS_{REFSENS}$  is the minimum mean power received at the RIB at which a reference performance requirement shall be met for a specified reference measurement channel.

The OTA REFSENS requirement shall apply to each supported polarization, under the assumption of *polarization match*.

### 10.3.2 IAB-DU OTA reference sensitivity level

#### 10.3.2.1 Minimum requirement for *IAB-DU type 1-O*

The wide area IAB-DU reference sensitivity level is specified the same as the wide area BS reference sensitivity level requirement for BS in TS 38.104[2], subclause 10.3.2, where references to *BS channel bandwidth* apply to *IAB-DU channel bandwidth*.

The medium range IAB-DU reference sensitivity level is specified the same as the medium range BS reference sensitivity level requirement for BS in TS 38.104[2], subclause 10.3.2, where references to *BS channel bandwidth* apply to *IAB-DU channel bandwidth*.

The local area IAB-DU reference sensitivity level is specified the same as the local area BS reference sensitivity level requirement for BS in TS 38.104[2], subclause 10.3.2, where references to *BS channel bandwidth* apply to *IAB-DU channel bandwidth*.

### 10.3.2.2 Minimum requirement for *IAB-DU type 2-0*

The wide area IAB-DU reference sensitivity level is specified the same as the wide area BS reference sensitivity level requirement for BS in TS 38.104[2], subclause 10.3.3, where references to *BS channel bandwidth* apply to *IAB-DU channel bandwidth*.

The medium range IAB-DU reference sensitivity level is specified the same as the medium range BS reference sensitivity level requirement for BS in TS 38.104[2], subclause 10.3.3, where references to *BS channel bandwidth* apply to *IAB-DU channel bandwidth*.

The local area IAB-DU reference sensitivity level is specified the same as the local area BS reference sensitivity level requirement for BS in TS 38.104[2], subclause 10.3.3, where references to *BS channel bandwidth* apply to *IAB-DU channel bandwidth*.

## 10.3.3 IAB-MT OTA reference sensitivity level

### 10.3.3.1 General

The OTA REFSENS requirement is a *directional requirement* and is intended to ensure the minimum OTA reference sensitivity level for a declared *OTA REFSENS RoAoA*. The OTA reference sensitivity power level  $EIS_{REFSENS}$  is the minimum mean power received at the RIB at which a reference performance requirement shall be met for a specified reference measurement channel.

### 10.3.3.2 Minimum requirement for *IAB-MT type 1-0*

The throughput shall be  $\geq 95\%$  of the maximum throughput of the reference measurement channel as specified in the corresponding table and annex A.1 when the OTA test signal is at the corresponding  $EIS_{REFSENS}$  level and arrives from any direction within the *OTA REFSENS RoAoA*.

**Table 10.3.3.2-1: Wide Area IAB-MT type 1-0 reference sensitivity levels**

<i>IAB-MT channel bandwidth (MHz)</i>	<i>Sub-carrier spacing (kHz)</i>	<i>Reference measurement channel</i>	<i>OTA reference sensitivity level, <math>EIS_{REFSENS}</math> (dBm)</i>
10, 15	30	G-FR1-A1-22	-102.0 - $\Delta_{OTAREFSNS}$
10, 15	60	G-FR1-A1-23	-99.0 - $\Delta_{OTAREFSNS}$
20, 25, 30, 35, 40, 45, 50, 60, 70, 80, 90, 100	30	G-FR1-A1-25	-95.4 - $\Delta_{OTAREFSNS}$
20, 25, 30, 35, 40, 45, 50, 60, 70, 80, 90, 100	60	G-FR1-A1-26	-95.6 - $\Delta_{OTAREFSNS}$
NOTE: $EIS_{REFSENS}$ is the power level of a single instance of the reference measurement channel. This requirement shall be met for each consecutive application of a single instance of the reference measurement channel mapped to disjoint frequency ranges with a width corresponding to the number of resource blocks of the reference measurement channel each, except for one instance that might overlap one other instance to cover the full <i>IAB-MT channel bandwidth</i> .			

Table 10.3.3.2-2: Local Area IAB-MT type 1-O reference sensitivity levels

<i>IAB-MT channel bandwidth</i> (MHz)	<i>Sub-carrier spacing</i> (kHz)	<i>Reference measurement channel</i>	<i>OTA reference sensitivity level, EIS<sub>REFSENS</sub></i> (dBm)
10, 15	30	G-FR1-A1-22	-94.0 - $\Delta_{OTAREFSNS}$
10, 15	60	G-FR1-A1-23	-91.0 - $\Delta_{OTAREFSNS}$
20, 25, 30, 35, 40, 45, 50, 60, 70, 80, 90, 100	30	G-FR1-A1-25	-87.4 - $\Delta_{OTAREFSNS}$
20, 25, 30, 35, 40, 45, 50, 60, 70, 80, 90, 100	60	G-FR1-A1-26	-87.6 - $\Delta_{OTAREFSNS}$
NOTE: EIS <sub>REFSENS</sub> is the power level of a single instance of the reference measurement channel. This requirement shall be met for each consecutive application of a single instance of the reference measurement channel mapped to disjoint frequency ranges with a width corresponding to the number of resource blocks of the reference measurement channel each, except for one instance that might overlap one other instance to cover the full <i>IAB-MT channel bandwidth</i> .			

### 10.3.3.3 Minimum requirement for *IAB-MT type 2-O*

The throughput shall be  $\geq 95\%$  of the maximum throughput of the reference measurement channel as specified in the corresponding table and annex A.1 when the OTA test signal is at the corresponding EIS<sub>REFSENS</sub> level and arrives from any direction within the *OTA REFSENS RoAoA*.

EIS<sub>REFSENS</sub> levels are derived from a single declared basis level EIS<sub>REFSENS\_50M</sub>, which is based on a reference measurement channel with 50 MHz *IAB-MT channel bandwidth*. EIS<sub>REFSENS\_50M</sub> itself is not a requirement and although it is based on a reference measurement channel with 50 MHz *IAB-MT channel bandwidth* it does not imply that IAB-MT has to support 50 MHz *IAB-MT channel bandwidth*.

For Wide Area IAB-MT, EIS<sub>REFSENS\_50M</sub> is an integer value in the range -96 to -119 dBm. The specific value is declared by the vendor.

For Local Area IAB-MT, EIS<sub>REFSENS\_50M</sub> is an integer value in the range -86 to -114 dBm. The specific value is declared by the vendor.

Table 10.3.3.2-1: FR2-1 OTA reference sensitivity requirement

<i>IAB-MT channel Bandwidth</i> (MHz)	<i>Sub-carrier spacing</i> (kHz)	<i>Reference measurement channel</i>	<i>OTA reference sensitivity level, EIS<sub>REFSENS</sub></i> (dBm)
50, 100, 200	60	G-FR2-A1-21	EIS <sub>REFSENS_50M</sub> + $\Delta_{FR2\_REFSENS}$
50	120	G-FR2-A1-22	EIS <sub>REFSENS_50M</sub> + $\Delta_{FR2\_REFSENS}$
100, 200, 400	120	G-FR2-A1-23	EIS <sub>REFSENS_50M</sub> + 3 + $\Delta_{FR2\_REFSENS}$
NOTE 1: EIS <sub>REFSENS</sub> is the power level of a single instance of the reference measurement channel. This requirement shall be met for each consecutive application of a single instance of the reference measurement channel mapped to disjoint frequency ranges with a width corresponding to the number of resource blocks of the reference measurement channel each, except for one instance that might overlap one other instance to cover the full <i>IAB-MT channel bandwidth</i> .			
NOTE 2: The declared EIS <sub>REFSENS_50M</sub> shall be within the range specified above.			

## 10.4 OTA Dynamic range

## 10.4.1 IAB-DU OTA dynamic range

### 10.4.1.1 General

The OTA dynamic range is a measure of the capability of the receiver unit to receive a wanted signal in the presence of an interfering signal inside the received *[IAB-DU] channel bandwidth*.

The requirement shall apply at the RIB when the AoA of the incident wave of a received signal and the interfering signal are from the same direction and are within the *OTA REFSENS RoAoA*.

The wanted and interfering signals apply to each supported polarization, under the assumption of *polarization match*.

### 10.4.1.2 Minimum requirement for *IAB-DU type 1-O*

The wide area IAB-DU dynamic range is specified the same as the wide area BS dynamic requirement for BS *type 1-O* in TS 38.104[2], subclause 10.4.2, where references to *BS channel bandwidth* apply to *IAB-DU channel bandwidth*.

The medium range IAB-DU dynamic range is specified the same as the medium range BS dynamic range requirement for BS *type 1-O* in TS 38.104[2], subclause 10.4.2, where references to *BS channel bandwidth* apply to *IAB-DU channel bandwidth*.

The local area IAB-DU dynamic range is specified the same as the local area BS dynamic range requirement for BS *type 1-O* in TS 38.104[2], subclause 10.4.2, where references to *BS channel bandwidth* apply to *IAB-DU channel bandwidth*.

## 10.5 OTA in-band selectivity and blocking

### 10.5.1 OTA adjacent channel selectivity

#### 10.5.1.1 General

OTA Adjacent channel selectivity (ACS) is a measure of the receiver's ability to receive an OTA wanted signal at its assigned channel frequency in the presence of an OTA adjacent channel signal with a specified centre frequency offset of the interfering signal to the band edge of a victim system.

#### 10.5.1.2 Minimum requirement for *IAB-DU type 1-O*

Minimum requirement is the same as specified for BS type 1-O in TS38.104[2], subclause 10.5.1.2.

#### 10.5.1.3 Minimum requirement for *IAB-DU type 2-O*

Minimum requirement is the same as specified for BS type 2-O in TS38.104[2], subclause 10.5.1.3.

#### 10.5.1.4 Minimum requirement for *IAB-MT type 2-O*

The requirement shall apply at the RIB when the AoA of the incident wave of a received signal and the interfering signal are from the same direction and are within the *OTA REFSENS RoAoA*.

The wanted and interfering signals apply to all supported polarizations, under the assumption of *polarization match*.

The throughput shall be  $\geq 95\%$  of the maximum throughput of the reference measurement channel.

For FR2-1, the OTA wanted and the interfering signal are specified in table 10.5.1.4-1 and table 10.5.1.4-2 for ACS. The reference measurement channel for the OTA wanted signal is further specified in annex A.1. The characteristics of the interfering signal is further specified in annex F.

The OTA ACS requirement is applicable outside the *IAB-MT RF Bandwidth*. The OTA interfering signal offset is defined relative to the *IAB-MT RF Bandwidth edges*.

For Wide Area IAB-MT, for RIBs supporting operation in *non-contiguous spectrum* within any *operating band*, the OTA ACS requirement shall apply in addition inside any sub-block gap, in case the sub-block gap size is at least as wide as the NR interfering signal in table 10.5.1.4-2. The OTA interfering signal offset is defined relative to the sub-block edges inside the sub-block gap.

**Table 10.5.1.4-1: OTA ACS requirement for Wide Area and Local Area IAB MT**

<b><i>IAB-MT channel bandwidth of the lowest/highest carrier received (MHz)</i></b>	<b><i>Wanted signal mean power (dBm)</i></b>	<b><i>Interfering signal mean power (dBm)</i></b>
50, 100, 200, 400	$EIS_{REFSENS} + 6$ dB (Note 3)	$EIS_{REFSENS\_50M} + 27.7 + \Delta_{FR2\_REFSENS}$ (Note 1) $EIS_{REFSENS\_50M} + 26.7 + \Delta_{FR2\_REFSENS}$ (Note 2)
NOTE 1: Applicable to bands defined within the frequency spectrum range of 24.25 – 33.4 GHz		
NOTE 2: Applicable to bands defined within the frequency spectrum range of 37 – 52.6 GHz		
NOTE 3: $EIS_{REFSENS}$ is given in subclause [ 10.3.3]		

**Table 10.5.1.4-2: OTA ACS interferer frequency offset for *IAB-MT type 2-O***

<b><i>IAB-MT channel bandwidth of the lowest/highest carrier received (MHz)</i></b>	<b><i>Interfering signal centre frequency offset from the lower/upper <i>IAB-MT RF Bandwidth edge</i> or <i>sub-block edge</i> inside a <i>sub-block gap</i> (MHz)</i></b>	<b><i>Type of interfering signal</i></b>
50	$\pm 24.29$	50 MHz CP-OFDM NR signal, 60 kHz SCS, 64 RBs
100	$\pm 24.31$	
200	$\pm 24.29$	
400	$\pm 24.31$	

### 10.5.1.5 Minimum requirement for *IAB-MT type 1-O*

The requirement shall apply at the RIB when the AoA of the incident wave of a received signal and the interfering signal are from the same direction and are within the *minSENS RoAoA*.

The wanted and interfering signals apply to each supported polarization, under the assumption of *polarization match*.

The throughput shall be  $\geq 95\%$  of the maximum throughput of the reference measurement channel.

For FR1, the OTA wanted and the interfering signal are specified in table 10.5.1.5-1, table 10.5.1.5-2 and table 10.5.1.5-3 for OTA ACS. The reference measurement channel for the OTA wanted signal is further specified in annex A.1. The characteristics of the interfering signal is further specified in annex F.

The OTA ACS requirement is applicable outside the *IAB-MT RF Bandwidth* or *Radio Bandwidth*. The OTA interfering signal offset is defined relative to the *IAB-MT RF Bandwidth edges* or *Radio Bandwidth edges*.

For RIBs supporting operation in *non-contiguous spectrum* within any *operating band*, the OTA ACS requirement shall apply in addition inside any *sub-block gap*, in case the *sub-block gap* size is at least as wide as the NR interfering signal in table 10.5.1.5-2 and table table 10.5.1.5-3. The OTA interfering signal offset is defined relative to the *sub-block edges* inside the *sub-block gap*.

For *multi-band RIBs*, the OTA ACS requirement shall apply in addition inside any *Inter RF Bandwidth gap*, in case the *Inter RF Bandwidth gap* size is at least as wide as the NR interfering signal in table 10.5.1.5-2 and table 10.5.1.5-3. The interfering signal offset is defined relative to the *IAB-MT RF Bandwidth edges* inside the *Inter RF Bandwidth gap*.

Table 10.5.1.5-1: OTA ACS requirement for *IAB-MT*

<i>IAB-MT channel bandwidth of the lowest/highest carrier received (MHz)</i>	<i>Wanted signal mean power (dBm) (Note 2)</i>	<i>Interfering signal mean power (dBm)</i>
10, 15, 20, 25, 30, 35, 40, 45, 50, 60, 70, 80, 90, 100 (Note 1)	$EIS_{\min SENS} + 6$ dB	Wide Area IAB-MT: $-52 - \Delta_{\min SENS}$ Local Area IAB-MT: $-44 - \Delta_{\min SENS}$
NOTE 1: The SCS for the <i>lowest/highest carrier</i> received is the lowest SCS supported by the IAB-MT for that bandwidth		
NOTE 2: $EIS_{\min SENS}$ depends on the IAB-MT <i>channel bandwidth</i>		

Table 10.5.1.5-2: OTA ACS interferer frequency offset for *IAB-MT type 1-0*

<i>IAB-MT channel bandwidth of the lowest/highest carrier received (MHz)</i>	<i>Interfering signal centre frequency offset from the lower/upper IAB-MT RF Bandwidth edge or sub-block edge inside a sub-block gap (MHz)</i>	<i>Type of interfering signal</i>
10	$\pm 2.5075$	5 MHz CP-OFDM NR signal, 15 kHz SCS, 25 RBs
15	$\pm 2.5125$	
20	$\pm 2.5025$	
25	$\pm 9.4675$	20 MHz CP-OFDM NR signal, 15 kHz SCS, 100 RBs
30	$\pm 9.4725$	
35	$\pm 9.4625$	
40	$\pm 9.4675$	
45	$\pm 9.4725$	
50	$\pm 9.4625$	
60	$\pm 9.4725$	
70	$\pm 9.4675$	
80	$\pm 9.4625$	
90	$\pm 9.4725$	
100	$\pm 9.4675$	

## 10.5.2 OTA in-band blocking

### 10.5.2.1 General

The OTA in-band blocking characteristics is a measure of the receiver's ability to receive a OTA wanted signal at its assigned channel in the presence of an unwanted OTA interferer, which is an NR signal for general blocking or an NR signal with one RB for narrowband blocking.

### 10.5.2.2 Minimum requirement for *IAB-DU type 1-0*

Minimum requirement is the same as specified for BS type 1-0 in TS38.104[2], subclause 10.5.2.2.

### 10.5.2.3 Minimum requirement for *IAB DU type 2-0*

Minimum requirement is the same as specified for BS type 2-0 in TS38.104[2], subclause 10.5.2.3.

### 10.5.2.4 Minimum requirement for *IAB-MT of type 2-0*

The requirement shall apply at the RIB when the AoA of the incident wave of a received signal and the interfering signal are from the same direction and are within the *OTA REFSENS RoAoA*.

The wanted and interfering signals apply to each supported polarization, under the assumption of *polarization match*.

The throughput shall be  $\geq 95\%$  of the maximum throughput of the reference measurement channel.

For Wide Area *IAB-MT type 2-O*, the OTA wanted and OTA interfering signals are provided at RIB using the parameters in table 10.5.2.4-1 for general OTA blocking requirements. The reference measurement channel for the wanted signal is further specified in annex A.1. The characteristics of the interfering signal is further specified in annex F.

The OTA blocking requirements are applicable outside the IAB-MT RF Bandwidth. The interfering signal offset is defined relative to the *IAB-MT RF Bandwidth edges*.

For Wide Area *IAB-MT type 2-O* the OTA in-band blocking requirement shall apply from  $F_{DL\_low} - \Delta f_{OOB}$  to  $F_{DL\_high} + \Delta f_{OOB}$ . The  $\Delta f_{OOB}$  for *IAB-MT type 2-O* is defined in table 10.5.2.4-0.

**Table 10.5.2.4-0:  $\Delta f_{OOB}$  offset for NR operating bands for Wide Area IAB-MT in FR2-1**

IAB-MT type	Operating band characteristics	$\Delta f_{OOB}$ (MHz)
<i>IAB-MT type 2-O</i>	$F_{DL\_high} - F_{DL\_low} \leq 3250$ MHz	1500

For Wide Area IAB-MT and for a RIBs supporting operation in *non-contiguous spectrum* within any *operating band*, the OTA blocking requirements apply in addition inside any sub-block gap, in case the sub-block gap size is at least as wide as twice the interfering signal minimum offset in table 10.5.2.4-1. The interfering signal offset is defined relative to the sub-block edges inside the sub-block gap.

**Table 10.5.2.4-1: General OTA blocking requirement for Wide Area IAB-MT**

<i>IAB MT channel bandwidth of the lowest/highest carrier received (MHz)</i>	OTA wanted signal mean power (dBm)	OTA interfering signal mean power (dBm)	OTA interfering signal centre frequency offset from the lower/upper IAB MT [ RF Bandwidth] edge or sub-block edge inside a sub-block gap (MHz)	Type of OTA interfering signal
50, 100, 200, 400	$EIS_{REFSENS} + 6$ dB	$EIS_{REFSENS\_50M} + 33 + \Delta_{FR2\_REFSENS}$	$\pm 75$	50 MHz CP-OFDM NR signal, 60 kHz SCS, 64 RBs
NOTE: $EIS_{REFSENS}$ and $EIS_{REFSENS\_50M}$ are given in subclause [ 10.3.3].				

### 10.5.2.5 Minimum requirement for *IAB-MT of type 1-O*

The requirement shall apply at the RIB when the AoA of the incident wave of a received signal and the interfering signal are from the same direction, and:

- when the wanted signal is based on  $EIS_{REFSENS}$ : the AoA of the incident wave of a received signal and the interfering signal are within the *OTA REFSENS RoAoA*.
- when the wanted signal is based on  $EIS_{minSENS}$ : the AoA of the incident wave of a received signal and the interfering signal are within the *minSENS RoAoA*.

The wanted and interfering signals apply to each supported polarization, under the assumption of *polarization match*.

The throughput shall be  $\geq 95\%$  of the maximum throughput of the reference measurement channel, with OTA wanted and OTA interfering signal specified in tables 10.5.2.5-1, table 10.5.2.5-2 and table 10.5.2.5-3 for general OTA and narrowband OTA blocking requirements. The reference measurement channel for the OTA wanted signal is identified in clause 10.3.3 and are further specified in annex A.1. The characteristics of the interfering signal is further specified in annex F.



The OTA in-band blocking requirements apply outside the *IAB-MT RF Bandwidth* or *Radio Bandwidth*. The interfering signal offset is defined relative to the *IAB-MT RF Bandwidth edges* or *Radio Bandwidth edges*.

For *IAB-MT type 1-O* the OTA in-band blocking requirement shall apply in the in-band blocking frequency range, which is from  $F_{DL,low} - \Delta f_{OOB}$  to  $F_{DL,high} + \Delta f_{OOB}$ . The  $\Delta f_{OOB}$  for *wide area IAB-MT type 1-O* is defined in table 10.5.2.5-0.

**Table 10.5.2.5-0:  $\Delta f_{OOB}$  offset for NR operating bands in FR1**

IAB-MT type	Operating band characteristics	$\Delta f_{OOB}$ (MHz)
<i>IAB-MT type 1-O</i>	$F_{DL,high} - F_{DL,low} < 100$ MHz	20
	$100 \text{ MHz} \leq F_{DL,high} - F_{DL,low} \leq 900$ MHz	60

For RIBs supporting operation in *non-contiguous spectrum* within any *operating band*, the OTA in-band blocking requirements apply in addition inside any *sub-block gap*, in case the *sub-block gap* size is at least as wide as twice the interfering signal minimum offset in table 10.5.2.5-1. The interfering signal offset is defined relative to the *sub-block edges* inside the *sub-block gap*.

For *multi-band RIBs*, the OTA in-band blocking requirements apply in the in-band blocking frequency ranges for each supported *operating band*. The requirement shall apply in addition inside any *Inter RF Bandwidth gap*, in case the *Inter RF Bandwidth gap* size is at least as wide as twice the interfering signal minimum offset in tables 10.5.2.5-1 and 10.5.2.5-3.

For a RIBs supporting operation in *non-contiguous spectrum* within any *operating band*, the OTA narrowband blocking requirements apply in addition inside any *sub-block gap*, in case the *sub-block gap* size is at least as wide as the interfering signal minimum offset in table 10.5.2.5-3. The interfering signal offset is defined relative to the *sub-block edges* inside the *sub-block gap*.

For a *multi-band RIBs*, the OTA narrowband blocking requirements apply in the narrowband blocking frequency ranges for each supported *operating band*. The requirement shall apply in addition inside any *Inter RF Bandwidth gap*, in case the *Inter RF Bandwidth gap* size is at least as wide as the interfering signal minimum offset in table 10.5.2.5-3.

**Table 10.5.2.5-1: General OTA blocking requirement for *IAB-MT type 1-O***

<i>IAB-MT channel bandwidth of the lowest/highest carrier received (MHz)</i>	Wanted signal mean power (dBm)	Interfering signal mean power (dBm)	Interfering signal centre frequency minimum offset from the lower/upper <i>IAB-MT RF Bandwidth edge</i> or <i>sub-block edge</i> inside a <i>sub-block gap</i> (MHz)	Type of interfering signal
10, 15, 20	$EIS_{REFSENS} + 6$ dB	Wide Area IAB-MT: -43 - $\Delta_{OTAREFS}$ Local Area IAB-MT: -35 - $\Delta_{OTAREFS}$	$\pm 7.5$	5 MHz CP-OFDM NR signal, 15 kHz SCS, 25 RBs
	$EIS_{minSENS} + 6$ dB	Wide Area IAB-MT: -43 - $\Delta_{minSENS}$ Local Area IAB-MT: -35 - $\Delta_{minSENS}$	$\pm 7.5$	
25, 30, 35, 40, 45, 50, 60, 70, 80, 90, 100	$EIS_{REFSENS} + 6$ dB	Wide Area IAB-MT: -43 - $\Delta_{OTAREFS}$ Local Area IAB-MT: -35 - $\Delta_{OTAREFS}$	$\pm 30$	20 MHz CP-OFDM NR signal, 15 kHz SCS, 100 RBs
	$EIS_{minSENS} + 6$ dB	Wide Area IAB-MT: -43 - $\Delta_{minSENS}$ Local Area IAB-MT: -35 - $\Delta_{minSENS}$	$\pm 30$	

**Table 10.5.2.5-2: OTA narrowband blocking requirement for IAB-MT type 1-0**

<b>IAB-MT channel bandwidth of the lowest/highest carrier received (MHz)</b>	<b>OTA Wanted signal mean power (dBm)</b>	<b>OTA Interfering signal mean power (dBm)</b>
10, 15, 20	EIS <sub>REFSENS</sub> + 6 dB	Wide Area IAB-MT: -49 - Δ <sub>OTAREFSENS</sub> Local Area IAB-MT: -41 - Δ <sub>OTAREFSENS</sub>
	EIS <sub>minSENS</sub> + 6 dB	Wide Area IAB-MT: -49 - Δ <sub>minSENS</sub> Local Area IAB-MT: -41 - Δ <sub>OTAREFSENS</sub>
25, 30, 35, 40, 45, 50, 60, 70, 80, 90, 100	EIS <sub>REFSENS</sub> + 6 dB	Wide Area IAB-MT: -49 - Δ <sub>OTAREFSENS</sub> Local Area IAB-MT: -41 - Δ <sub>OTAREFSENS</sub>
	EIS <sub>minSENS</sub> + 6 dB	Wide Area IAB-MT: -49 - Δ <sub>minSENS</sub> Local Area IAB-MT: -41 - Δ <sub>OTAREFSENS</sub>
NOTE 1: The SCS for the <i>lowest/highest carrier</i> received is the lowest SCS supported by the IAB-MT for that bandwidth.		
NOTE 2: 7.5 kHz shift is not applied to the wanted signal.		

**Table 10.5.2.5-3: OTA narrowband blocking interferer frequency offsets for IAB-MT type 1-0**

<b>IAB-MT channel bandwidth of the lowest/highest carrier received (MHz)</b>	<b>Interfering RB centre frequency offset to the lower/upper IAB-MT RF Bandwidth edge or sub-block edge inside a sub-block gap (kHz) (Note 2)</b>	<b>Type of interfering signal</b>
		5 MHz CP-OFDM NR signal, 15 kHz SCS, 1 RB
10	±(355 + m*180), m=0, 1, 2, 3, 4, 9, 14, 19, 24	
15	±(360 + m*180), m=0, 1, 2, 3, 4, 9, 14, 19, 24	
20	±(350 + m*180), m=0, 1, 2, 3, 4, 9, 14, 19, 24	
25	±(565 + m*180), m=0, 1, 2, 3, 4, 29, 54, 79, 99	20 MHz CP-OFDM NR signal, 15 kHz SCS, 1 RB
30	±(570 + m*180), m=0, 1, 2, 3, 4, 29, 54, 79, 99	
35	±(560+m*180), m=0, 1, 2, 3, 4, 29, 54, 79, 99	
40	±(565 + m*180), m=0, 1, 2, 3, 4, 29, 54, 79, 99	
45	±(570+m*180), m=0, 1, 2, 3, 4, 29, 54, 79, 99	
50	±(560 + m*180), m=0, 1, 2, 3, 4, 29, 54, 79, 99	
60	±(570 + m*180), m=0, 1, 2, 3, 4, 29, 54, 79, 99	
70	±(565 + m*180), m=0, 1, 2, 3, 4, 29, 54, 79, 99	
80	±(560 + m*180), m=0, 1, 2, 3, 4, 29, 54, 79, 99	
90	±(570 + m*180), m=0, 1, 2, 3, 4, 29, 54, 79, 99	
100	±(565 + m*180), m=0, 1, 2, 3, 4, 29, 54, 79, 99	
NOTE 1: Interfering signal consisting of one resource block is positioned at the stated offset, the channel bandwidth of the interfering signal is located adjacently to the lower/upper IAB-MT RF Bandwidth edge or sub-block edge inside a sub-block gap.		
NOTE 2: The centre of the interfering RB refers to the frequency location between the two central subcarriers.		

## 10.6 OTA out-of-band blocking

### 10.6.1 General

The OTA out-of-band blocking characteristics are a measure of the receiver unit ability to receive a wanted signal at the RIB at its assigned channel in the presence of an unwanted interferer.

### 10.6.2 Minimum requirement for IAB-MT type 1-O and IAB-DU type 1-O

The requirement shall apply at the RIB when the AoA of the incident wave of the received signal and the interfering signal are from the same direction and are within the *minSENS RoAoA*.

The wanted signal applies to each supported polarization, under the assumption of *polarization match*. The interferer shall be *polarization matched* in-band and the polarization maintained for out-of-band frequencies.

For OTA wanted and OTA interfering signals provided at the RIB using the parameters in table 10.6.2-2, the following requirements shall be met:

- The throughput shall be  $\geq 95\%$  of the maximum throughput of the reference measurement channel. The reference measurement channel for the OTA wanted signal is identified in clause 10.3.2 and subclause 10.3.3 for each *IAB-Node channel bandwidth*.

For a *multi-band RIB*, the OTA out-of-band requirement shall apply for each supported *operating band*, with the exception that the in-band blocking frequency ranges of all supported *operating bands* according to table 10.6.2-1 shall be excluded from the OTA out-of-band blocking requirement.

For OTA out-of-band blocking requirement apply from 30 MHz to  $F_{UL,low} - \Delta f_{OOB}$  and from  $F_{UL,high} + \Delta f_{OOB}$  up to 12750 MHz. The  $\Delta f_{OOB}$  for FR1 OTA out-of-band blocking requirement is defined in table 10.6.2-1.

**Table 10.6.2-1:  $\Delta f_{OOB}$**

Operating band characteristics	$\Delta f_{OOB}$ (MHz)
$F_{UL,high} - F_{UL,low} < 100$ MHz	20
$100 \text{ MHz} \leq F_{UL,high} - F_{UL,low} \leq 900$ MHz	60

**Table 10.6.2-2: OTA out-of-band blocking performance requirement**

Wanted signal mean power (dBm)	Interfering signal RMS field-strength (V/m)	Type of interfering Signal
$EIS_{minSENS} + 6$ dB (Note 1)	0.36	CW
NOTE 1: $EIS_{minSENS}$ depends on the <i>channel bandwidth</i> as specified in clause 9.2. NOTE 2: The RMS field-strength level in V/m is related to the interferer EIRP level at a distance described as $E = \frac{\sqrt{30EIRP}}{r}$ , where EIRP is in W and r is in m; for example, 0.36 V/m is equivalent to 36 dBm at fixed distance of 30 m.		

### 10.6.3 Minimum requirement for IAB-MT type 2-O and IAB-DU type 2-O

The requirement shall apply at the RIB when the AoA of the incident wave of the received signal and the interfering signal are from the same direction and are within the *OTA REFSENS RoAoA*.

The wanted signal applies to each supported polarization, under the assumption of *polarization match*. The interferer shall be polarization matched in-band and the polarization maintained for out-of-band frequencies.

For *IAB type 2-O* the OTA out-of-band blocking requirement apply from 30 MHz to  $F_{UL,low} - 1500$  MHz and from  $F_{UL,high} + 1500$  MHz up to 2<sup>nd</sup> harmonic of the upper frequency edge of the *operating band*.

For OTA wanted and OTA interfering signals provided at the RIB using the parameters in table 10.6.3-1, the following requirements shall be met:

- The throughput shall be  $\geq 95\%$  of the maximum throughput of the reference measurement channel. The reference measurement channel for the OTA wanted signal is identified in subclause 10.3.2 and subclause 10.3.3 for each *IAB Node channel bandwidth*.

**Table 10.6.3-1: OTA out-of-band blocking performance requirement**

Frequency range of interfering signal (MHz)	Wanted signal mean power (dBm)	Interferer RMS field-strength (V/m)	Type of interfering signal
30 to 12750	EIS <sub>REFSENS</sub> + 6 dB	0.36	CW
12750 to F <sub>UL,low</sub> – 1500	EIS <sub>REFSENS</sub> + 6 dB	0.1	CW
F <sub>UL,high</sub> + 1500 to 2 <sup>nd</sup> harmonic of the upper frequency edge of the <i>operating band</i>	EIS <sub>REFSENS</sub> + 6 dB	0.1	CW

## 10.6.4 Co-location minimum requirement for IAB-MT type 1-O and IAB-DU type 1-O

This additional OTA out-of-band blocking requirement may be applied for the protection of IAB receivers when NR, E-UTRA BS, UTRA BS, CDMA BS, GSM/EDGE BS or IAB-DU and/or IAB-MT operating in a different frequency band are co-located with an IAB-Node.

The requirement is a co-location requirement. The interferer power levels are specified at the *co-location reference antenna* conducted input. The interfering signal power is specified per supported polarization.

The requirement is valid over the *minSENS RoAoA*.

For OTA wanted and OTA interfering signal provided at the RIB using the parameters in table 10.6.4-1, the following requirements shall be met:

- The throughput shall be  $\geq 95\%$  of the maximum throughput of the reference measurement channel. The reference measurement channel for the OTA wanted signal is identified in clause 10.3 for each *IAB channel bandwidth* and further specified in annex A.1. The characteristics of the interfering signal is further specified in annex F.

For *IAB type 1-O* the OTA blocking requirement for co-location with BS or IAB-Node in other frequency bands is applied for all *operating bands* for which co-location protection is provided.

**Table 10.6.4-1: OTA blocking requirement for co-location with BS or IAB-Node in other frequency bands**

Frequency range of interfering signal	Wanted signal mean power (dBm)	Interfering signal mean power for WA BS (dBm)	Interfering signal mean power for MR BS (dBm)	Interfering signal mean power for LA BS (dBm)	Type of interfering signal
Frequency range of co-located downlink <i>operating band</i>	EIS <sub>minSENS</sub> + 6 dB (Note 1)	+46	+38	+24	CW carrier
NOTE 1: EIS <sub>minSENS</sub> depends on the IAB class and on the <i>IAB channel bandwidth</i> , see clause 10.3.					
NOTE 2: The requirement does not apply when the interfering signal falls within any of the supported downlink <i>operating band(s)</i> or in $\Delta f_{OOB}$ immediately outside any of the supported downlink <i>operating band(s)</i> .					

## 10.7 OTA receiver spurious emissions

### 10.7.1 General

The OTA RX spurious emission is the power of the emissions radiated from the antenna array from a receiver unit.

The metric used to capture OTA receiver spurious emissions for IAB-MT and IAB-DU for *IAB type 1-O* and *IAB type 2-O* is *total radiated power* (TRP), with the requirement defined at the RIB.

For *IAB-MT type 1-O* manufacturer shall declare  $N_{RXU,OTAactive}$ .  $N_{RXU,OTAactive}$  active receiver units supporting the same *operating band* is implementation dependent.

The number of active receiver units that are considered when calculating the radiated RX spurious emission limits ( $N_{RXU,OTApercell}$ ) for *IAB-MT type 1-O* is calculated as follows:

$$N_{RXU,OTApercell} = \min(N_{RXU,OTAactive}, 8)$$

$N_{RXU,OTApercell}$  is used for scaling of *basic limits*.

## 10.7.2 IAB-DU OTA receiver spurious emissions

### 10.7.2.1 Minimum requirement for IAB-DU type 1-O

Minimum requirement is the same as specified for BS type 1-O in TS 38.104[2], subclause 10.7.2.

### 10.7.2.2 Minimum requirement for IAB-DU type 2-O

Minimum requirement is the same as specified for BS type 2-O in TS 38.104[2], subclause 10.7.3.

## 10.7.3 IAB-MT OTA receiver spurious emissions

### 10.7.3.1 Minimum requirement for IAB-MT type 1-O

For an IAB-MT operating in TDD, the OTA RX spurious emissions requirement shall apply during the *transmitter OFF period* only.

For RX only *multi-band RIB*, the OTA RX spurious emissions requirements are subject to exclusion zones in each supported *operating band*.

The OTA RX spurious emissions requirement for *IAB-MT type 1-O* is that for each *basic limit* specified in table 10.7.3.1-1, the power sum of emissions at the RIB shall not exceed limits specified as the *basic limit* + X, where  $X = 10\log_{10}(N_{RXU,OTApercell})$  dB, unless stated differently in regional regulation.

**Table 10.7.3.1-1: General receiver spurious emission basic limits for IAB-MT type 1-O**

Spurious frequency range	Basic limit (Note 4)	Measurement bandwidth	Notes
30 MHz – 1 GHz	-36 dBm	100 kHz	Note 1
1 GHz – 12.75 GHz	-30 dBm	1 MHz	Note 1, Note 2
12.75 GHz – 5 <sup>th</sup> harmonic of the upper frequency edge of the DL operating band in GHz		1 MHz	Note 1, Note 2, Note 3
NOTE 1: Measurement bandwidths as in ITU-R SM.329 [16], s4.1.			
NOTE 2: Upper frequency as in ITU-R SM.329 [16], s2.5 table 1.			
NOTE 3: This spurious frequency range applies only for <i>operating bands</i> for which the 5 <sup>th</sup> harmonic of the upper frequency edge of the DL <i>operating band</i> is reaching beyond 12.75 GHz.			
NOTE 4: Additional limits may apply regionally.			

### 10.7.3.2 Minimum requirement for IAB-MT type 2-O

The OTA RX spurious emissions requirement shall apply during the *transmitter OFF period* only.

For the Wide Area *IAB-MT type 2-O*, the power of any RX spurious emission shall not exceed the limits in table 10.7.3.2-1.

### 10.7.3.2-1: Radiated Rx spurious emission limits for IAB-MT type 2-O

Spurious frequency range (Note 4)	Limit (Note 5)	Measurement Bandwidth	Note
30 MHz ↔ 1 GHz	-36 dBm	100 kHz	Note 1
1 GHz ↔ 18 GHz	-30 dBm	1 MHz	Note 1
18 GHz ↔ $F_{\text{step},1}$	-20 dBm	10 MHz	Note 2
$F_{\text{step},1}$ ↔ $F_{\text{step},2}$	-15 dBm	10 MHz	Note 2
$F_{\text{step},2}$ ↔ $F_{\text{step},3}$	-10 dBm	10 MHz	Note 2
$F_{\text{step},4}$ ↔ $F_{\text{step},5}$	-10 dBm	10 MHz	Note 2
$F_{\text{step},5}$ ↔ $F_{\text{step},6}$	-15 dBm	10 MHz	Note 2
$F_{\text{step},6}$ ↔ 2 <sup>nd</sup> harmonic of the upper frequency edge of the DL <i>operating band</i>	-20 dBm	10 MHz	Note 2, Note 3
NOTE 1: Bandwidth as in ITU-R SM.329 [16], s4.1. NOTE 2: Limit and bandwidth as in ERC Recommendation 74-01 [17], Annex 2. NOTE 3: Upper frequency as in ITU-R SM.329 [16], s2.5 table 1. NOTE 4: The step frequencies $F_{\text{step},X}$ are defined in table 10.7.3.2-2. NOTE 5: Additional limits may apply regionally.			

Table 10.7.3.2-2: Step frequencies for defining the radiated Rx spurious emission limits for IAB-MT type 2-O

Operating band	$F_{\text{step},1}$ (GHz)	$F_{\text{step},2}$ (GHz)	$F_{\text{step},3}$ (GHz)	$F_{\text{step},4}$ (GHz)	$F_{\text{step},5}$ (GHz)	$F_{\text{step},6}$ (GHz)
n257	18	23.5	25	31	32.5	41.5
n258	18	21	22.75	29	30.75	40.5
n259	23.5	35.5	38	45	47.5	59.5
n260	25	34	35.5	41.5	43	52
n261	18	25.5	26.0	29.85	30.35	38.35

## 10.8 OTA receiver intermodulation

### 10.8.1 General

Third and higher order mixing of the two interfering RF signals can produce an interfering signal in the band of the desired channel. Intermodulation response rejection is a measure of the capability of the receiver unit to receive a wanted signal on its assigned channel frequency in the presence of two interfering signals which have a specific frequency relationship to the wanted signal. The requirement is defined as a directional requirement at the RIB.

### 10.8.2 Minimum requirement for IAB-DU type 1-O

The Wide Area IAB-DU receiver intermodulation requirement is specified the same as the Wide Area receiver intermodulation requirement for BS *type 1-O* in TS 38.104 [2], subclause 10.8.2, where references to *BS channel bandwidth* apply to *IAB-DU channel bandwidth*.

The Medium Range IAB-DU receiver intermodulation requirement is specified the same as the Medium Range BS receiver intermodulation requirement for BS *type 1-O* in TS 38.104 [2], subclause 10.8.2, where references to *BS channel bandwidth* apply to *IAB-DU channel bandwidth*.

The Local Area IAB-DU receiver intermodulation requirement is specified the same as the Local Area BS receiver intermodulation requirement for BS *type 1-O* in TS 38.104 [2], subclause 10.8.2, where references to *BS channel bandwidth* apply to *IAB-DU channel bandwidth*.

### 10.8.3 Minimum requirement for *IAB-DU type 2-O*

The Wide Area IAB-DU receiver intermodulation requirement is specified the same as the Wide Area receiver intermodulation requirement for BS *type 2-O* in TS 38.104 [2], subclause 10.8.3, where references to *BS channel bandwidth* apply to *IAB-DU channel bandwidth*.

The Medium Range IAB-DU receiver intermodulation requirement is specified the same as the Medium Range BS receiver intermodulation requirement for BS *type 2-O* in TS 38.104 [2], subclause 10.8.3, where references to *BS channel bandwidth* apply to *IAB-DU channel bandwidth*.

The Local Area IAB-DU receiver intermodulation requirement is specified the same as the Local Area BS receiver intermodulation requirement for BS *type 2-O* in TS 38.104 [2], subclause 10.8.3, where references to *BS channel bandwidth* apply to *IAB-DU channel bandwidth*.

### 10.8.4 Minimum requirement for *IAB-MT type 1-O*

The Wide Area IAB-MT receiver intermodulation requirement is specified the same as the Wide Area receiver intermodulation requirement for BS *type 1-O* in TS 38.104 [2], subclause 10.8.2, where references to *BS channel bandwidth* apply to *IAB-MT channel bandwidth*.

The Local Area IAB-MT receiver intermodulation requirement is specified the same as the Local Area BS receiver intermodulation requirement for BS *type 1-O* in TS 38.104 [2], subclause 10.8.2, where references to *BS channel bandwidth* apply to *IAB-MT channel bandwidth*.

Interfering signal for IAB-MT *type 1-O* should be CP-OFDM.

## 10.9 OTA in-channel selectivity

### 10.9.1 General

In-channel selectivity (ICS) is a measure of the receiver ability to receive a wanted signal at its assigned resource block locations in the presence of an interfering signal received at a larger power spectral density. In this condition a throughput requirement shall be met for a specified reference measurement channel. The interfering signal shall be an NR signal as specified in annex [A.1] and shall be time aligned with the wanted signal

### 10.9.2 Minimum requirement for *IAB-DU type 1-O*

The wide area IAB-DU receiver in-channel selectivity requirement is specified the same as the wide area receiver in-channel selectivity requirement for BS *type 1-O* in TS 38.104[2], subclause 10.9.2, where references to *BS channel bandwidth* apply to *IAB-DU channel bandwidth*.

The medium range IAB-DU receiver in-channel selectivity requirement is specified the same as the medium range BS receiver in-channel selectivity requirement for BS *type 1-O* in TS 38.104[2], subclause 10.9.2, where references to *BS channel bandwidth* apply to *IAB-DU channel bandwidth*.

The local area IAB-DU receiver in-channel selectivity requirement is specified the same as the local area BS receiver in-channel selectivity requirement for BS *type 1-O* in TS 38.104[2], subclause 10.9.2, where references to *BS channel bandwidth* apply to *IAB-DU channel bandwidth*.

### 10.9.3 Minimum requirement for *IAB-DU type 2-O*

The wide area IAB-DU receiver in-channel selectivity requirement is specified the same as the wide area receiver in-channel selectivity requirement for BS *type 2-O* in TS 38.104[2], subclause 10.9.3, where references to *BS channel bandwidth* apply to *IAB-DU channel bandwidth*.

The medium range IAB-DU receiver in-channel selectivity requirement is specified the same as the medium range BS receiver in-channel selectivity requirement for BS *type 2-O* in TS 38.104[2], subclause 10.9.3, where references to *BS channel bandwidth* apply to *IAB-DU channel bandwidth*.

The local area IAB-DU receiver in-channel selectivity requirement is specified the same as the local area BS receiver in-channel selectivity requirement for BS *type 2-O* in TS 38.104[2], subclause 10.9.3, where references to *BS channel bandwidth* apply to *IAB-DU channel bandwidth*.

---

## 11 Radiated performance requirements

### 11.1 IAB-DU performance requirements

#### 11.1.1 General

Radiated performance requirements specify the ability of the *IAB-DU type 1-O* or *IAB-DU type 2-O* to correctly demodulate radiated signals in various conditions and configurations. Radiated performance requirements are specified at the RIB.

Radiated performance requirements for the IAB-DU are specified for the fixed reference channels defined in annex A and the propagation conditions in annex I. The requirements only apply to those FRCs that are supported by the IAB-DU.

The radiated performance requirements for *IAB-DU type 1-O* and for *IAB-DU type 2-O* are limited to two OTA *demodulation branches* as described in clause 11.1.2. Conformance requirements can only be tested for 1 or 2 *demodulation branches* depending on the number of polarizations supported by the IAB-DU, with the required SNR applied separately per polarization.

NOTE 1: The IAB-DU can support more than 2 *demodulation branches*, however OTA conformance testing can only be performed for 1 or 2 *demodulation branches*.

Unless stated otherwise, radiated performance requirements apply for a single carrier only. Radiated performance requirements for a IAB-DU supporting CA are defined in terms of single carrier requirements.

In tests performed with signal generators a synchronization signal may be provided from the IAB-DU to the signal generator, to enable correct timing of the wanted signal.

Whenever the "RX antennas" term is used for the radiated performance requirements description, it shall refer to the *demodulation branches* (i.e. not physical antennas of the antenna array).

The SNR used in this clause is specified based on a single carrier and defined as:

$$\text{SNR} = S / N$$

Where:

S is the total signal energy in a slot on a RIB.

N is the noise energy in a bandwidth corresponding to the *transmission bandwidth* over the duration of a slot on a RIB.

#### 11.1.2 OTA demodulation branches

Radiated performance requirements are only specified for up to 2 *demodulation branches*.

If the *IAB-DU type 1-O*, or the *IAB-DU type 2-O* uses polarization diversity and has the ability to maintain isolation between the signals for each of the *demodulation branches*, then radiated performance requirements can be tested for up to two *demodulation branches* (i.e. 1RX or 2RX test setups). When tested for two *demodulation branches*, each demodulation branch maps to one polarization.

If the *IAB-DU type 1-O*, or the *IAB-DU type 2-O* does not use polarization diversity then radiated performance requirements can only be tested for a single *demodulation branch* (i.e. 1RX test setup).



## 11.1.2 Performance requirements for PUSCH

### 11.1.2.1 Performance requirements for IAB type 1-O

#### 11.1.2.1.1 Performance requirements for PUSCH with transform precoding disabled

Apply the requirements defined in clause 8.1.2.1 for 2Rx.

#### 11.1.2.1.2 Performance requirements for PUSCH with transform precoding enabled

Apply the requirements defined in clause 8.1.2.2 for 2Rx.

#### 11.1.2.1.3 Performance requirements for UCI multiplexed on PUSCH

Apply the requirements defined in clause 8.1.2.3 for 2Rx.

### 11.1.2.2 Performance requirements for IAB type 2-O

#### 11.1.2.2.1 Performance requirements for PUSCH with transform precoding disabled

##### 11.1.2.2.1.1 General

The performance requirement of PUSCH is determined by a minimum required throughput for a given SNR. The required throughput is expressed as a fraction of the maximum throughput for the FRCs listed in annex A. The performance requirements assume HARQ retransmissions.

**Table 11.1.2.2.1.1-1: Test parameters for PUSCH testing**

Parameter		Value
Transform precoding		Disabled
Default TDD UL-DL pattern (Note 1)		60 kHz and 120kHz SCS: 3D1S1U, S=10D:2G:2U
Cyclic prefix		Normal
HARQ	Maximum number of HARQ transmissions	4
	RV sequence	0, 2, 3, 1
DM-RS	DM-RS configuration type	1
	DM-RS duration	single-symbol DM-RS
	Additional DM-RS symbols	pos0, pos1
	Number of DM-RS CDM group(s) without data	2
	Ratio of PUSCH EPRE to DM-RS EPRE	-3 dB
	DM-RS port(s)	{0}, {0, 1}
DM-RS sequence generation		$N_{ID}=0$ , $n_{SCID}=0$
Time domain resource	PUSCH mapping type	B
	Start symbol index	0
	Allocation length	10
Frequency domain resource	RB assignment	Full applicable test bandwidth
	Frequency hopping	Disabled
TPMI index for 2Tx two-layer spatial multiplexing transmission		0
Code block group based PUSCH transmission		Disabled
PT-RS configuration	Frequency density ( $K_{PT-RS}$ )	2, Disabled
	Time density ( $L_{PT-RS}$ )	1, Disabled
Note 1: The same requirements are applicable to TDD with different UL-DL patterns.		

##### 11.1.2.2.1.2 Minimum requirements

The throughput shall be equal to or larger than the 70% of maximum throughput stated in the tables 11.1.2.2.1.2-1 to 11.1.2.2.1.2-5 at the given SNR for 1Tx and for 2Tx two-layer spatial multiplexing transmission.

Table 11.1.2.2.1.2-1: Minimum requirements for PUSCH, 50 MHz channel bandwidth, 60 kHz SCS

Number of TX antennas	Number of demodulation branches	Propagation conditions and correlation matrix (Annex I)	FRC (Annex A)	Additional DM-RS position	PT-RS	SNR (dB)
1	2	TDLA30-300 Low	D-FR2-A.2.1-1	pos0	No	-2.0
			D-FR2-A.2.1-13	pos1	No	-2.2
			D-FR2-A.2.3-1	pos0	Yes	12.0
					No	11.5
		D-FR2-A.2.3-11	pos1	Yes	10.7	
				No	10.7	
		TDLA30-75 Low	D-FR2-A.2.4-1	pos0	Yes	13.7
					No	13.1
D-FR2-A.2.4-6	pos1		Yes	13.4		
			No	12.9		
2	2	TDLA30-300 Low	D-FR2-A.2.1-6	pos0	No	1.5
			D-FR2-A.2.1-18	pos1	No	1.2
			D-FR2-A.2.2-1	pos0	Yes	15.2
					No	14.3
		D-FR2-A.2.2-6	pos1	Yes	13.8	
				No	13.0	

Table 11.1.2.2.1.2-2: Minimum requirements for PUSCH, 100 MHz channel bandwidth, 60 kHz SCS

Number of TX antennas	Number of demodulation branches	Propagation conditions and correlation matrix (Annex I)	FRC (Annex A)	Additional DM-RS position	PT-RS	SNR (dB)
1	2	TDLA30-300 Low	D-FR2-A.2.1-2	pos0	No	-2.1
			D-FR2-A.2.1-14	pos1	No	-2.4
			D-FR2-A.2.3-2	pos0	Yes	12.2
					No	11.2
		D-FR2-A.2.3-12	pos1	Yes	11.2	
				No	10.6	
		TDLA30-75 Low	D-FR2-A.2.4-2	pos0	Yes	14.2
					No	13.3
D-FR2-A.2.4-7	pos1		Yes	13.7		
			No	13.1		
2	2	TDLA30-300 Low	D-FR2-A.2.1-7	pos0	No	1.5
			D-FR2-A.2.1-19	pos1	No	1.2
			D-FR2-A.2.2-2	pos0	Yes	16.0
					No	14.9
		D-FR2-A.2.2-7	pos1	Yes	13.8	
			No	13.1		

Table 11.1.2.2.1.2-3: Minimum requirements for PUSCH, 50 MHz channel bandwidth, 120 kHz SCS

Number of TX antennas	Number of demodulation branches	Propagation conditions and correlation matrix (Annex I)	FRC (Annex A)	Additional DM-RS position	PT-RS	SNR (dB)
1	2	TDLA30-300 Low	D-FR2-A.2.1-3	pos0	No	-1.8
			D-FR2-A.2.1-15	pos1	No	-2.1
			D-FR2-A.2.3-3	pos0	Yes	11.6
					No	10.9
			D-FR2-A.2.3-13	pos1	Yes	10.9
					No	10.5

2	TDLA30-75 Low	D-FR2-A.2.4-3	pos0	Yes	13.7
				No	13.1
		D-FR2-A.2.4-8	pos1	Yes	13.2
				No	13.0
	TDLA30-300 Low	D-FR2-A.2.1-8	pos0	No	1.4
		D-FR2-A.2.1-20	pos1	No	1.3
		D-FR2-A.2.2-3	pos0	Yes	14.2
				No	13.6
		D-FR2-A.2.2-8	pos1	Yes	13.9

Table 11.1.2.2.1.2-4: Minimum requirements for PUSCH, 100 MHz channel bandwidth, 120 kHz SCS

Number of TX antennas	Number of demodulation branches	Propagation conditions and correlation matrix (Annex I)	FRC (Annex A)	Additional DM-RS position	PT-RS	SNR (dB)
1	2	TDLA30-300 Low	D-FR2-A.2.1-4	pos0	No	-2.4
			D-FR2-A.2.1-16	pos1	No	-2.5
			D-FR2-A.2.3-4	pos0	Yes	11.9
					No	10.5
		D-FR2-A.2.3-14	pos1	Yes	11.1	
				No	10.5	
		TDLA30-75 Low	D-FR2-A.2.4-4	pos0	Yes	13.5
					No	12.9
D-FR2-A.2.4-9	pos1	Yes	13.4			
		No	12.8			
2	TDLA30-300 Low	D-FR2-A.2.1-9	pos0	No	1.4	
		D-FR2-A.2.1-21	pos1	No	1.2	
		D-FR2-A.2.2-4	pos0	Yes	13.9	
				No	13.2	
		D-FR2-A.2.2-9	pos1	Yes	13.5	

Table 11.1.2.2.1.2-5: Minimum requirements for PUSCH, 200 MHz channel bandwidth, 120 kHz SCS

Number of TX antennas	Number of demodulation branches	Propagation conditions and correlation matrix (Annex I)	FRC (Annex A)	Additional DM-RS position	PT-RS	SNR (dB)
1	2	TDLA30-300 Low	D-FR2-A.2.1-5	pos0	No	-2.1
			D-FR2-A.2.1-17	pos1	No	-2.4
			D-FR2-A.2.3-5	pos0	Yes	11.3
					No	10.9
		D-FR2-A.2.3-15	pos1	Yes	11.2	
				No	10.7	
		TDLA30-75 Low	D-FR2-A.2.4-5	pos0	Yes	14.1
					No	13.4
D-FR2-A.2.4-10	pos1	Yes	13.7			
		No	13.3			
2	TDLA30-300 Low	D-FR2-A.2.1-10	pos0	No	1.4	
		D-FR2-A.2.1-22	pos1	No	1.1	
		D-FR2-A.2.2-5	pos0	Yes	14.0	
				No	13.3	
		D-FR2-A.2.2-10	pos1	Yes	13.6	

11.1.2.2.2 Performance requirements for PUSCH with transform precoding enabled

11.1.2.2.2.1 General

The performance requirement of PUSCH is determined by a minimum required throughput for a given SNR. The required throughput is expressed as a fraction of the maximum throughput for the FRCs listed in Annex A. The performance requirements assume HARQ retransmissions.

**Table 11.1.2.2.2.1-1: Test parameters for PUSCH testing**

Parameter		Value
Transform precoding		Enabled
Default TDD UL-DL pattern (Note 1)		60 kHz and 120kHz SCS: 3D1S1U, S=10D:2G:2U
Cyclic prefix		Normal
HARQ	Maximum number of HARQ transmissions	4
	RV sequence	0, 2, 3, 1
DM-RS	DM-RS configuration type	1
	DM-RS duration	single-symbol DM-RS
	Additional DM-RS position	pos0, pos1
	Number of DM-RS CDM group(s) without data	2
	Ratio of PUSCH EPRE to DM-RS EPRE	-3 dB
	DM-RS port(s)	0
Time domain resource assignment	PUSCH mapping type	B
	Start symbol	0
	Allocation length	10
Frequency domain resource assignment	RB assignment	30 PRBs in the middle of the test bandwidth
	Frequency hopping	Disabled
Code block group based PUSCH transmission		Disabled
PT-RS		Not configured
Note 1: The same requirements are applicable to TDD with different UL-DL patterns.		

11.1.2.2.2.2 Minimum requirements

The throughput shall be equal to or larger than the 70% of maximum throughput stated in the tables 11.1.2.2.2.2-1 to 11.1.2.2.2.2-2 at the given SNR.

**Table 11.1.2.2.2.2-1: Minimum requirements for PUSCH, Type B, 50 MHz Channel Bandwidth, 60 kHz SCS**

Number of TX antennas	Number of demodulation branches	Propagation conditions and correlation matrix (Annex I)	FRC (Annex A)	Additional DM-RS position	SNR (dB)
1	2	TDLA30-300 Low	D-FR2-A.2.1-11	pos0	-1.8
			D-FR2-A.2.1-23	pos1	-1.9

**Table 11.1.2.2.2.2-2: Minimum requirements for PUSCH, Type B, 50 MHz Channel Bandwidth, 120 kHz SCS**

Number of TX antennas	Number of demodulation branches	Propagation conditions and correlation matrix (Annex I)	FRC (Annex A)	Additional DM-RS position	SNR (dB)
1	2	TDLA30-300 Low	D-FR2-A.2.1-12	pos0	-1.8
			D-FR2-A.2.1-24	pos1	-1.9

### 11.1.2.2.3 Performance requirements for UCI multiplexed on PUSCH

#### 11.1.2.2.3.1 General

In the tests for UCI multiplexed on PUSCH the UCI information only contains CSI part 1 and CSI part 2 information and there is no HACK/ACK information transmitted.

The CSI part 1 block error probability is defined as the probability of incorrectly decoded the CSI part 1 information when the CSI part 1 information is sent as follow:

$$BLER_{CSI\ part\ 1} = \frac{\#(\text{false CSI part 1})}{\#(\text{CSI part 1})}$$

where:

- #(false CSI part 1) denotes the number of incorrectly decoded CSI part 1 information transmitted occasions
- #(CSI part 1) denotes the number of CSI part 1 information transmitted occasions.

The CSI part 2 block error probability (BLER) is defined as the probability of incorrectly decoded the CSI part 2 information when the CSI part 2 information is sent as follows:

$$BLER_{CSI\ part\ 2} = \frac{\#(\text{false CSI part 2})}{\#(\text{CSI part 2})}$$

where:

- #(false CSI part 2) denotes the number of incorrectly decoded CSI part 2 information transmitted occasions
- #(CSI part 2) denotes the number of CSI part 2 information transmitted occasions.

The number of UCI information bit payload per slot is defined for two cases as follows:

- 5 bits in CSI part 1, 2 bits in CSI part 2
- 20 bits in CSI part 1, 20 bits in CSI part 2

The 7bits UCI case is further defined with the bitmap [c0 c1 c2 c3 c4] = [0 1 0 1 0] for CSI part 1 information, where c0 is mapping to the RI information, and with the bitmap [c0 c1] = [1 0] for CSI part2 information.

The 40bits UCI information case is assumed random information bit selection.

In both tests, PUSCH data, CSI part 1 and CSI part 2 information are transmitted simultaneously.

Table 11.1.2.2.3.1-1: Test parameters for UCI multiplexed on PUSCH testing

Parameter		Value	
Transform precoding		Disabled	
Default TDD UL-DL pattern (Note 1)		120 kHz SCS: 3D1S1U, S=10D:2G:2U	
Cyclic prefix		Normal	
HARQ	Maximum number of HARQ transmissions	1	
	RV sequence	0	
DM-RS	DM-RS configuration type	1	
	DM-RS duration	single-symbol DM-RS	
	Additional DM-RS position	pos0, pos1	
	Number of DM-RS CDM group(s) without data	2	
	Ratio of PUSCH EPRE to DM-RS EPRE	-3 dB	
	DM-RS port(s)	{0}	
	DM-RS sequence generation	$N_{ID}^0=0, n_{SCID}=0$	
Time domain resource assignment	PUSCH mapping type	B	
	Start symbol	0	
	Allocation length	10	
Frequency domain resource assignment	RB assignment	Full applicable test bandwidth	
	Frequency hopping	Disabled	
Code block group based PUSCH transmission		Disabled	
PT-RS configuration	PT-RS	Disabled	Enabled
	Frequency density ( $K_{PT-RS}$ )	N/A:	2
	Time density ( $L_{PT-RS}$ )	N/A	1
UCI	Number of CSI part 1 and CSI part 2 information bit payload	{5,2},{20,20}	
	<i>scaling</i>	1	
	<i>betaOffsetACK-Index1</i>	11	
	<i>betaOffsetCSI-Part1-Index1 and betaOffsetCSI-Part1-Index2</i>	13	
	<i>betaOffsetCSI-Part2-Index1 and betaOffsetCSI-Part2-Index2</i>	13	
	UCI partition for frequency hopping	Disabled	
Note 1: The same requirements are applicable to TDD with different UL-DL patterns.			

## 11.1.2.2.3.2 Minimum requirements

The CSI part 1 block error probability shall not exceed 0.1% at the SNR given in table 11.1.2.2.3.2-1 and table 11.1.2.2.3.2-2. The CSI part 2 block error probability shall not exceed 1% at the SNR given in table 11.1.2.2.3.2-3 and table 11.1.2.2.3.2-4.

Table 11.1.2.2.3.2-1: Minimum requirements for UCI multiplexed on PUSCH, Type B, With PT-RS, CSI part 1, 50 MHz Channel Bandwidth, 120 kHz SCS

Number of TX antennas	Number of demodulation branches	Propagation conditions and correlation matrix (Annex I)	UCI bits (CSI part 1, CSI part 2)	Additional DM-RS position	FRC (Annex A)	SNR (dB)
1	2	TDLA30-300 Low	7(5,2)	pos0	D-FR2-A.2.3-3	7.2
	2	TDLA30-300 Low	40(20,20)	pos0	D-FR2-A.2.3-3	5.8
	2	TDLA30-300 Low	7(5,2)	pos1	D-FR2-A.2.3-13	7.8
	2	TDLA30-300 Low	40(20,20)	pos1	D-FR2-A.2.3-13	5.9

**Table 11.1.2.2.3.2-2: Minimum requirements for UCI multiplexed on PUSCH, Type B, Without PTRS, CSI part 1, 50 MHz Channel Bandwidth, 120 kHz SCS**

Number of TX antennas	Number of demodulation branches	Propagation conditions and correlation matrix (Annex I)	UCI bits (CSI part 1, CSI part 2)	Additional DM-RS position	FRC (Annex A)	SNR (dB)
1	2	TDLA30-300 Low	7(5,2)	pos0	D-FR2-A.2.3-3	7.1
	2	TDLA30-300 Low	40(20,20)	pos0	D-FR2-A.2.3-3	5.8
	2	TDLA30-300 Low	7(5,2)	pos1	D-FR2-A.2.3-13	7.3
	2	TDLA30-300 Low	40(20,20)	pos1	D-FR2-A.2.3-13	5.5

**Table 11.1.2.2.3.2-3: Minimum requirements for UCI multiplexed on PUSCH, Type B, With PTRS, CSI part 2, 50 MHz Channel Bandwidth, 120 kHz SCS**

Number of TX antennas	Number of demodulation branches	Propagation conditions and correlation matrix (Annex I)	UCI bits (CSI part 1, CSI part 2)	Additional DM-RS position	FRC (Annex A)	SNR (dB)
1	2	TDLA30-300 Low	7(5,2)	pos0	D-FR2-A.2.3-3	1.1
	2	TDLA30-300 Low	40(20,20)	pos0	D-FR2-A.2.3-3	4.0
	2	TDLA30-300 Low	7(5,2)	pos1	D-FR2-A.2.3-13	1.3
	2	TDLA30-300 Low	40(20,20)	pos1	D-FR2-A.2.3-13	4.0

**Table 11.1.2.2.3.2-4: Minimum requirements for UCI multiplexed on PUSCH, Type B, Without PTRS, CSI part 2, 50 MHz Channel Bandwidth, 120 kHz SCS**

Number of TX antennas	Number of demodulation branches	Propagation conditions and correlation matrix (Annex I)	UCI bits (CSI part 1, CSI part 2)	Additional DM-RS position	FRC (Annex A)	SNR (dB)
1	2	TDLA30-300 Low	7(5,2)	pos0	D-FR2-A.2.3-3	1.1
	2	TDLA30-300 Low	40(20,20)	pos0	D-FR2-A.2.3-3	3.9
	2	TDLA30-300 Low	7(5,2)	pos1	D-FR2-A.2.3-13	1.2
	2	TDLA30-300 Low	40(20,20)	pos1	D-FR2-A.2.3-13	3.7

### 11.1.3 Performance requirements for PUCCH

#### 11.1.3.1 Performance requirements for *IAB type 1-0*

##### 11.1.3.1.1 DTX to ACK probability

Apply the requirements defined in clause 8.1.3.1

##### 11.1.3.1.2 Performance requirements for PUCCH format 0

Apply the requirements defined in clause 8.1.3.2 for 2 Rx.

##### 11.1.3.1.3 Performance requirements for PUCCH format 1

Apply the requirements defined in clause 8.1.3.3 for 2Rx.

##### 11.1.3.1.4 Performance requirements for PUCCH format 2

Apply the requirements defined in clause 8.1.3.4 for 2Rx.

##### 11.1.3.1.5 Performance requirements for PUCCH format 3

Apply the requirements defined in clause 8.1.3.5 for 2Rx.

### 11.1.3.1.6 Performance requirements for PUCCH format 4

Apply the requirements defined in clause 8.1.3.6 for 2Rx.

### 11.1.3.1.7 Performance requirements for multi-slot PUCCH

Apply the requirements defined in clause 8.1.3.7 for 2Rx.

## 11.1.3.2 Performance requirements for *IAB type 2-0*

### 11.1.3.2.1 DTX to ACK probability

Apply the requirements defined in clause 8.1.3.1.

### 11.1.3.2.2 Performance requirements for PUCCH format 0

#### 11.1.3.2.2.1 General

The ACK missed detection probability is the probability of not detecting an ACK when an ACK was sent.

**Table 11.1.3.2.2.1-1: Test parameters for PUCCH format 0 testing**

Parameter	Value
Cyclic prefix	Normal
Number of UCI information bits	1
Number of PRBs	1
First PRB prior to frequency hopping	0
Intra-slot frequency hopping	N/A for 1 symbol Enabled for 2 symbols
First PRB after frequency hopping	The largest PRB index – (Number of PRBs - 1)
Group and sequence hopping	neither
Hopping ID	0
Initial cyclic shift	0
First symbol	13 for 1 symbol 12 for 2 symbols

The transient period as specified in TS 38.101-1 [3] clause 6.3.3.1 is not taken into account for performance requirement testing, where the RB hopping is symmetric to the CC centre, i.e. intra-slot frequency hopping is enabled.

#### 11.1.3.2.2.2 Minimum requirements

The ACK missed detection probability shall not exceed 1% at the SNR given in table 11.1.3.2.2.2-1 and in table 11.1.3.2.2.2-2.

**Table 11.1.3.2.2.2-1: Minimum requirements for PUCCH format 0 and 60 kHz SCS**

Number of TX antennas	Number of demodulation branches	Propagation conditions and correlation matrix (Annex I)	Number of OFDM symbols	Channel bandwidth / SNR (dB)	
				50 MHz	100 MHz
1	2	TDLA30-300 Low	1	9.3	9.0
			2	4.2	4.0



**Table 11.1.3.2.2-2: Minimum requirements for PUCCH format 0 and 120 kHz SCS**

Number of TX antennas	Number of demodulation branches	Propagation conditions and correlation matrix (Annex I)	Number of OFDM symbols	Channel bandwidth / SNR (dB)		
				50 MHz	100 MHz	200 MHz
1	2	TDLA30-300 Low	1	9.5	9.2	9.7
			2	4.1	3.8	4.0

### 11.1.3.2.3 Performance requirements for PUCCH format 1

#### 11.1.3.2.3.1 NACK to ACK requirements

##### 11.1.3.2.3.1.1 General

The NACK to ACK detection probability is the probability that an ACK bit is falsely detected when an NACK bit was sent on the particular bit position, where the NACK to ACK detection probability is defined as follows:

$$\text{Prob}(\text{PUCCH NACK} \rightarrow \text{ACK bits}) = \frac{\#(\text{NACK bits decoded as ACK bits})}{\#(\text{Total NACK bits})}$$

where:

- $\#(\text{Total NACK bits})$  denotes the total number of NACK bits transmitted
- $\#(\text{NACK bits decoded as ACK bits})$  denotes the number of NACK bits decoded as ACK bits at the receiver, i.e. the number of received ACK bits
- NACK bits in the definition do not contain the NACK bits which are mapped from DTX, i.e. NACK bits received when DTX is sent should not be considered.

Random codeword selection is assumed.

**Table 11.1.3.2.3.1.1-1: Test Parameters for PUCCH format 1 testing**

Parameter	Test
Cyclic prefix	Normal
Number of information bits	2
Number of PRBs	1
Number of symbols	14
First PRB prior to frequency hopping	0
Intra-slot frequency hopping	enabled
First PRB after frequency hopping	The largest PRB index – (nrofPRBs – 1)
Group and sequence hopping	neither
Hopping ID	0
Initial cyclic shift	0
First symbol	0
Index of orthogonal cover code (timeDomainOCC)	0

The transient period as specified in TS 38.101-1 [3] and TS 38.101-2 [4] clause 6.3.3.1 is not taken into account for performance requirement testing, where the RB hopping is symmetric to the CC centre, i.e. intra-slot frequency hopping is enabled.

##### 11.1.3.2.3.1.2 Minimum requirements

The NACK to ACK probability shall not exceed 0.1% at the SNR given in Table 11.1.3.2.3.1.2-1 and Table 11.1.3.2.3.1.2-2.

**Table 11.1.3.2.3.1.2-1: Minimum requirements for PUCCH format 1 with 60 kHz SCS**

Number of TX antennas	Number of Demodulation Branches	Propagation conditions and correlation matrix (Annex I)	Channel bandwidth / SNR (dB)	
			50 MHz	100 MHz
1	2	TDLA30-300 Low	-1.2	-4.2

**Table 11.1.3.2.3.1.2-2: Minimum requirements for PUCCH format 1 with 120 kHz SCS**

Number of TX antennas	Number of Demodulation Branches	Propagation conditions and correlation matrix (Annex I)	Channel bandwidth / SNR (dB)		
			50 MHz	100 MHz	200 MHz
1	2	TDLA30-300 Low	-3.9	-3.9	-3.0

#### 11.1.3.2.3.2 ACK missed detection requirements

##### 11.1.3.2.3.2.1 General

The ACK missed detection probability is the probability of not detecting an ACK when an ACK was sent. The test parameters in Table 11.1.3.2.3.1.1-1 are configured.

The transient period as specified in TS 38.101-1 [3] clause 6.3.3.1 is not taken into account for performance requirement testing, where the RB hopping is symmetric to the CC centre, i.e. intra-slot frequency hopping is enabled.

##### 11.1.3.2.3.2.2 Minimum requirements

The ACK missed detection probability shall not exceed 1% at the SNR given in Table 11.1.3.2.3.2.2-1 and in Table 11.1.3.2.3.2.2-2.

**Table 11.1.3.2.3.2.2-1: Minimum requirements for PUCCH format 1 with 60 kHz SCS**

Number of TX antennas	Number of Demodulation Branches	Propagation conditions and correlation matrix (Annex I)	Channel bandwidth / SNR (dB)	
			50 MHz	100 MHz
1	2	TDLA30-300 Low	-3.9	-4.2

**Table 11.1.3.2.3.2.2-2: Minimum requirements for PUCCH format 1 with 120 kHz SCS**

Number of TX antennas	Number of Demodulation Branches	Propagation conditions and correlation matrix (Annex I)	Channel bandwidth / SNR (dB)		
			50 MHz	100 MHz	200 MHz
1	2	TDLA30-300 Low	-4.7	-4.6	-4.6

#### 11.1.3.2.4 Performance requirements for PUCCH format 2

##### 11.1.3.2.4.1 ACK missed detection requirements

##### 11.1.3.2.4.1.1 General

The ACK missed detection probability is the probability of not detecting an ACK when an ACK was sent.

The ACK missed detection requirement only applies to the PUCCH format 2 with 4 UCI bits.

**Table 11.1.3.2.4.1.1-1: Test Parameters for PUCCH format 2 testing**

Parameter	Value
Cyclic prefix	Normal
Modulation order	QSPK
First PRB prior to frequency hopping	0
Intra-slot frequency hopping	N/A
First PRB after frequency hopping	The largest PRB index – (Number of PRBs – 1)
Number of PRBs	4
Number of symbols	1
The number of UCI information bits	4
First symbol	13
DM-RS sequence generation	$N_{ID}^0=0$

The transient period as specified in TS 38.101-1 [3] clause 6.3.3.1 is not taken into account for performance requirement testing, where the RB hopping is symmetric to the CC center, i.e. intra-slot frequency hopping is enabled.

The ACK missed detection probability shall not exceed 1% at the SNR given in table 11.1.3.2.4.1.2-1 and table 11.1.3.2.4.1.2-2 for 4 UCI bits.

**Table 11.1.3.2.4.1.2-1: Minimum requirements for PUCCH format 2 with 60 kHz SCS**

Number of TX antennas	Number of demodulation branches	Propagation conditions and correlation matrix (Annex I)	Channel bandwidth / SNR (dB)	
			50 MHz	100 MHz
1	2	TDLA30-300 Low	6.7	7.2

**Table 11.1.3.2.4.1.2-2: Minimum requirements for PUCCH format 2 with 120 kHz SCS**

Number of TX antennas	Number of demodulation branches	Propagation conditions and correlation matrix (Annex I)	Channel bandwidth / SNR (dB)		
			50 MHz	100 MHz	200 MHz
1	2	TDLA30-300 Low	6.6	6.3	6.6

#### 11.1.3.2.4.2 UCI BLER performance requirements

##### 11.1.3.2.4.2.1 General

The UCI block error probability (BLER) is defined as the probability of incorrectly decoded UCI information when the UCI information is sent. The UCI information does not contain CSI part 2.

The transient period as specified in TS 38.101-1 [3] clause 6.3.3.1 is not taken into account for performance requirement testing, where the RB hopping is symmetric to the CC centre, i.e. intra-slot frequency hopping is enabled.

The UCI performance only applies to the PUCCH format 2 with 22 UCI bits.

**Table 11.1.3.2.4.2.1-1: Test Parameters for UCI BLER testing**

Parameter	Value
Cyclic prefix	Normal
Modulation order	QSPK
First PRB prior to frequency hopping	0
Intra-slot frequency hopping	enabled
First PRB after frequency hopping	The largest PRB index - (Number of PRBs-1)
Number of PRBs	9
Number of symbols	2
The number of UCI information bits	22
First symbol	12
DM-RS sequence generation	$N_{ID}^0=0$

## 11.1.3.2.4.2.2 Minimum requirements

The UCI block error probability shall not exceed 1% at the SNR given in table 11.1.3.2.4.2.2-1 and table 11.1.3.2.4.2.2-2 for 22 UCI bits.

**Table 11.1.3.2.4.2.2-1: Minimum requirements for PUCCH format 2 with 60 kHz SCS**

Number of TX antennas	Number of demodulation branches	Propagation conditions and correlation matrix (Annex I)	Channel bandwidth / SNR (dB)	
			50 MHz	100 MHz
1	2	TDLA30-300 Low	2.6	1.1

**Table 11.1.3.2.4.2.2-2: Minimum requirements for PUCCH format 2 with 120 kHz SCS**

Number of TX antennas	Number of demodulation branches	Propagation conditions and correlation matrix (Annex I)	Channel bandwidth / SNR (dB)		
			50 MHz	100 MHz	200 MHz
1	2	TDLA30-300 Low	1.2	1.2	1.1

## 11.1.3.2.5 Performance requirements for PUCCH format 3

## 11.1.3.2.5.1 General

The performance is measured by the required SNR at UCI block error probability not exceeding 1%.

The UCI block error probability is defined as the conditional probability of incorrectly decoding the UCI information when the UCI information is sent. The UCI information does not contain CSI part 2.

The transient period as specified in TS 38.101-2 [4] clause 6.3.3.1 is not taken into account for performance requirement testing, where the RB hopping is symmetric to the CC centre, i.e. intra-slot frequency hopping is enabled.

**Table 11.1.3.2.5.1-1: Test parameters for PUCCH format 3 testing**

Parameter	Test 1	Test 2
Cyclic prefix	Normal	
Modulation order	QPSK	
First PRB prior to frequency hopping	0	
Intra-slot frequency hopping	enabled	
First PRB after frequency hopping	The largest PRB index – (Number of PRBs – 1)	
Group and sequence hopping	neither	
Hopping ID	0	
Number of PRBs	1	3
Number of symbols	14	4
The number of UCI information bits	16	16
First symbol	0	0

## 11.1.3.2.5.2 Minimum requirements

The UCI block error probability shall not exceed 1% at the SNR given in Table 11.1.3.2.5.2-1 and Table 11.1.3.2.5.2-2.

**Table 11.1.3.2.5.2-1: Required SNR for PUCCH format 3 with 60 kHz SCS**

Test Number	Number of TX antennas	Number of demodulation branches	Propagation conditions and correlation matrix (Annex I)	Additional DM-RS configuration	Channel Bandwidth / SNR (dB)	
					50 MHz	100 MHz
1	1	2	TDLA30-300 Low	No additional DM-RS	1.6	0.7
				Additional DM-RS	1.3	0.9
2	1	2	TDLA30-300 Low	No additional DM-RS	3.0	2.4

Table 11.1.3.2.5.2-2: Required SNR for PUCCH format 3 with 120kHz SCS

Test Number	Number of TX antennas	Number of demodulation branches	Propagation conditions and correlation matrix (Annex I)	Additional DM-RS configuration	Channel Bandwidth / SNR (dB)		
					50 MHz	100 MHz	200 MHz
1	1	2	TDLA30-300 Low	No additional DM-RS	1.4	0.7	0.7
				Additional DM-RS	1.3	1.4	0.9
2	1	2	TDLA30-300 Low	No additional DM-RS	1.1	2.9	1.4

## 11.1.3.2.6 Performance requirements for PUCCH format 4

## 11.1.3.2.6.1 General

The performance is measured by the required SNR at UCI block error probability not exceeding 1%.

The UCI block error probability is defined as the conditional probability of incorrectly decoded UCI information when the UCI information is sent. The UCI information does not contain CSI part 2.

The transient period as specified in TS 38.101-1 [3] clause 6.3.3.1 is not taken into account for performance requirement testing, where the RB hopping is symmetric to the CC centre, i.e. intra-slot frequency hopping is enabled.

Table 11.1.3.2.6.1-1: Test parameters for PUCCH format 4 testing

Parameter	Value
Cyclic prefix	Normal
Modulation	QPSK
First PRB prior to frequency hopping starting PRB	0
Number of PRBs	1
Intra-slot frequency hopping	enabled
First PRB after frequency hopping	The largest PRB index – (Number of PRBs – 1)
Group and sequence hopping	neither
Hopping ID	0
Number of symbols	14
The number of UCI information bits	22
First symbol	0
Length of the orthogonal cover code	n2
Index of the orthogonal cover code	n0

## 11.1.3.2.6.2 Minimum requirements

The UCI block error probability shall not exceed 1% at the SNR given in Table 11.1.3.2.6.2-1 and Table 11.1.3.2.6.2-2.

Table 11.1.3.2.6.2-1: Minimum requirements for PUCCH format 4 with 60 kHz SCS

Number of TX antennas	Number of demodulation branches	Propagation conditions and correlation matrix (Annex I)	Additional DM-RS configuration	Channel Bandwidth / SNR (dB)	
				50 MHz	100 MHz
1	2	TDLA30-300 Low	No additional DM-RS	3.0	2.7
			Additional DM-RS	3.1	3.5

Table 11.1.3.2.6.2-2: Minimum requirements for PUCCH format 4 with 120 kHz SCS

Number of TX antennas	Number of demodulation branches	Propagation conditions and correlation matrix (Annex I)	Additional DM-RS configuration	Channel Bandwidth / SNR (dB)		
				50 MHz	100 MHz	200MHz
1	2	TDLA30-300 Low	No additional DM-RS	2.8	2.8	3.5
			Additional DM-RS	3.6	3.8	3.2

## 11.1.4 Performance requirements for PRACH

### 11.1.4.1 Performance requirements for *IAB type 1-O*

#### 11.1.4.1.1 PRACH False alarm probability

Apply the requirements defined in clause 8.1.4.1 for 2Rx.

#### 11.1.4.1.2 PRACH detection requirements

Apply the requirements defined in clause 8.1.4.2 for 2Rx.

### 11.1.4.2 Performance requirements for *IAB type 2-O*

#### 11.1.4.2.1 PRACH false alarm probability

##### 11.1.4.2.1.1 General

The false alarm requirement is valid for any number of receive antennas, for any channel bandwidth.

The false alarm probability is the conditional total probability of erroneous detection of the preamble (i.e. erroneous detection from any detector) when input is only noise.

##### 11.1.4.2.1.2 Minimum requirement

The false alarm probability shall be less than or equal to 0.1%.

#### 11.1.4.2.2 PRACH missed detection requirements

##### 11.1.4.2.2.1 General

The probability of detection is the conditional probability of correct detection of the preamble when the signal is present. There are several error cases – detecting different preamble than the one that was sent, not detecting a preamble at all or correct preamble detection but with the wrong timing estimation. For AWGN and TDLA30-300, a timing estimation error occurs if the estimation error of the timing of the strongest path is larger than the time error tolerance given in Table 11.1.4.2.2.1-1.

**Table 11.1.4.2.2.1-1: Time error tolerance for AWGN and TDLA30-300**

PRACH preamble	PRACH SCS (kHz)	Time error tolerance	
		AWGN	TDLA30-300
A1, A2, A3, B4, C0, C2	60	0.13 us	0.28 us
	120	0.07 us	0.22 us

The test preambles for normal mode are listed in table A.2.5-2 and the test parameter *msg1-FrequencyStart* is set to 0.

##### 11.1.4.2.2.2 Minimum requirements

The probability of detection shall be equal to or exceed 99% for the SNR levels listed in Tables 11.1.4.2.2.2-1 to 11.1.4.2.2.2-2.

Table 11.1.4.2.2-1: PRACH missed detection requirements for Normal Mode, 60 kHz SCS

Number of TX antennas	Number of demodulation branches	Propagation conditions and correlation matrix (Annex I)	Frequency offset	SNR (dB)					
				Burst format A1	Burst format A2	Burst format A3	Burst format B4	Burst format C0	Burst format C2
1	2	AWGN	0	-8.9	-11.9	-13.5	-15.8	-6.0	-11.8
		TDLA30-300 Low	4000 Hz	-1.6	-3.8	-4.8	-6.9	1.1	-3.9

Table 11.1.4.2.2-2: PRACH missed detection requirements for Normal Mode, 120 kHz SCS

Number of TX antennas	Number of demodulation branches	Propagation conditions and correlation matrix (Annex I)	Frequency offset	SNR (dB)					
				Burst format A1	Burst format A2	Burst format A3	Burst format B4	Burst format C0	Burst format C2
1	2	AWGN	0	-8.7	-11.5	-13.3	-15.8	-5.8	-11.4
		TDLA30-300 Low	4000 Hz	-1.7	-4.4	-5.8	-7.5	1.2	-4.2

## 11.2 IAB-MT performance requirements

### 11.2.1 General

Radiated performance requirements specify the ability of the *IAB-MT type 1-O* or the *IAB-MT type 2-O* to correctly demodulate radiated signals in various conditions and configurations. Radiated performance requirements are specified at the RIB.

Radiated performance requirements for the IAB-MT are specified for the fixed reference channels defined in annex A and the propagation conditions in annex I. The requirements only apply to those FRCs that are supported by the IAB-MT.

The radiated performance requirements for the *IAB-MT type 1-O* and for the *IAB-MT type 2-O* are limited to two OTA *demodulation branches* as described in clause 11.2.2. Conformance requirements can only be tested for 1 or 2 *demodulation branches* depending on the number of polarizations supported by the IAB-MT, with the required SNR applied separately per polarization.

NOTE 1: The IAB-MT can support more than 2 *demodulation branches*, however OTA conformance testing can only be performed for 1 or 2 *demodulation branches*.

Unless stated otherwise, radiated performance requirements apply for a single carrier only.

Whenever the "RX antennas" term is used for the radiated performance requirements description, it shall refer to the *demodulation branches* (i.e. not physical antennas of the antenna array).

The SNR used in this clause is specified based on a single carrier and defined as:

$$\text{SNR} = S / N$$

Where:

*S* is the total signal energy in a slot on a RIB.

*N* is the noise energy in a bandwidth corresponding to the *transmission bandwidth* over the duration of a slot on a RIB

Radiated performance requirements are only specified for up to 2 *demodulation branches*.

## 11.2.2 OTA demodulation branches

If the *IAB-MT type 1-O*, or the *IAB-MT type 2-O* uses polarization diversity and has the ability to maintain isolation between the signals for each of the *demodulation branches*, then radiated performance requirements can be tested for up to two *demodulation branches* (i.e. 1RX or 2RX test setups). When tested for two *demodulation branches*, each demodulation branch maps to one polarization.

If the *IAB-MT type 1-O*, or the *IAB-MT type 2-O* does not use polarization diversity then radiated performance requirements can only be tested for a single *demodulation branch* (i.e. 1RX test setup).

## 11.2.2 Demodulation performance requirements

### 11.2.2.1 Performance requirements for IAB type 1-O

#### 11.2.2.1.1 Performance requirements for PDSCH

##### 11.2.2.1.1.1 General

The performance requirement of PDSCH is determined by a minimum required throughput for a given SNR. The required throughput is expressed as a fraction of maximum throughput for the FRCs listed in annex A. The performance requirements assume HARQ retransmissions.

**Table: 11.2.2.1.1.1-1 Test parameters for PDSCH testing**

Parameter		Value
Cyclic prefix		Normal
Default TDD UL-DL pattern (Note 1)		7D1S2U, S=6D:4G:4U
HARQ	Maximum number of HARQ transmissions	4
	RV sequence	0, 2, 3, 1
DM-RS	DM-RS configuration type	1
	DM-RS duration	single-symbol DM-RS
	DM-RS position ( $l_0$ )	2
	Additional DM-RS position	pos1
	Number of DM-RS CDM group(s) without data	1 for Rank 1 and Rank 2 tests 2 for Rank 3 and Rank 4 tests
	DM-RS port(s)	{1000} for Rank 1 tests {1000-1001} for Rank 2 tests {1000-1002} for Rank 3 tests {1000-1003} for Rank 4 tests
DM-RS sequence generation		$N_{ID}^0=0$
Time domain resource assignment	PDSCH mapping type	A
	Start symbol	2
	Allocation length	12



Frequency domain resource assignment	RB assignment	Full applicable test bandwidth
PT-RS configuration	Not configured	
PRB bundling size	2	
VRB-to-PRB mapping type	Not interleaved	
PDSCH & PDSCH DMRS Precoding configuration	Single Panel Type I, Random precoder selection updated per slot, with equal probability of each applicable $i_1, i_2$ combination, and with PRB bundling granularity	
Note 1: The same requirements are applicable to TDD with different UL-DL patterns.		
Note 2: SSB, TRS, CSI-RS, and/or other unspecified test parameters with respect to TS 38.101-4 [28] are left up to test implementation, if transmitted or needed.		

11.2.2.1.1.2 Minimum requirements

The throughput shall be equal to or larger than the fraction of maximum throughput for the FRCs stated in tables 11.2.2.1.1.2-1 and 11.2.2.1.1.2-2 at the given SNR with the test parameters stated in Table 11.2.2.1.1.1-1.

**Table 11.2.2.1.1.2-1: Minimum requirements for PDSCH with Rank 1, 40 MHz Channel Bandwidth, 30 kHz SCS**

Number of TX antennas	Number of demodulation branches	Propagation conditions and correlation matrix (Annex I)	FRC (Annex A)	Fraction of maximum throughput (%)	SNR (dB)
2	2	TDLA30-10, ULA Low	M-FR1-A.3.3-1	70	25.3
		TDLA30-10, ULA Low	M-FR1-A.3.1-1	30	2.2

**Table 11.2.2.1.1.2-2: Minimum requirements for PDSCH with Rank 2, 40 MHz Channel Bandwidth, 30 kHz SCS**

Number of TX antennas	Number of demodulation branches	Propagation conditions and correlation matrix (Annex I)	FRC (Annex A)	Fraction of maximum throughput (%)	SNR (dB)
2	2	TDLA30-10, ULA Low	M-FR1-A.3.2-1	70	19.8

11.2.2.1.2 Performance requirements for PDCCH

11.2.2.1.2.1 General

The receiver characteristics of the PDCCH are determined by the probability of miss-detection of the Downlink Scheduling Grant (Pm-dsg).

**Table: 11.2.2.1.2.1-1 Test parameters for PDCCH testing**

Parameter	Value
Cyclic prefix	Normal
Default TDD UL-DL pattern (Note 1)	7D1S2U, S=6D:4G:4U
DM-RS sequence generation	$N_{ID}=0$
Frequency domain resource allocation for CORESET	Start from RB = 0 with contiguous RB allocation
CCE to REG mapping type	Interleaved
Interleaver size	3
REG bundle size	6 for test with aggregation level 8 2 for others
Shift Index	0
Slots for PDCCH monitoring	Each slot
Number of PDCCH candidates for the tested aggregation level	1
PDCCH Precoding configuration	Single Panel Type I, Random precoder selection updated per slot, with equal probability of each applicable $i_1, i_2$ combination with REG bundling granularity for number of Tx larger than 1
Note 1:	The same requirements are applicable to TDD with different UL-DL patterns.
Note 2:	SSB, TRS, CSI-RS, and/or other unspecified test parameters with respect to TS 38.101-4 [28] are left up to test implementation, if transmitted or needed.

#### 11.2.2.1.2.2 Minimum requirements

The Pm-dsg shall be equal to or smaller than 1%, for the cases stated in Table 11.2.2.1.2.2-1 at the given SNR with the test parameters stated in Table 11.2.2.1.2.1-1.

**Table 11.2.2.1.2.2-1: Minimum requirements for PDCCH, 40 MHz Channel Bandwidth, 30 kHz SCS**

Antenna configuration	CORESET RB	CORESET duration	Aggregation level	FRC (Annex A)	Propagation conditions and correlation matrix (Annex I)	Pm-dsg (%)	SNR (dB)
1x2	102	1	2	M-FR1-A.3.4-1	TDLA30-10, Low	1	7.0
1x2	102	1	4	M-FR1-A.3.4-1	TDLA30-10, Low	1	4.9
2x2	90	1	8	M-FR1-A.3.4-1	TDLA30-10, Low	1	-0.7

#### 11.2.2.2 Performance requirements for IAB type 2-O

##### 11.2.2.2.1 Performance requirements for PDSCH

###### 11.2.2.2.1.1 General

The performance requirement of PDSCH is determined by a minimum required throughput for a given SNR. The required throughput is expressed as a fraction of maximum throughput for the FRCs listed in annex A. The performance requirements assume HARQ retransmissions.

**Table: 11.2.2.2.1.1-1 Test parameters for PDSCH testing**

Parameter		Value
Cyclic prefix		Normal
Default TDD UL-DL pattern (Note 1)		3D1S1U, S=10D:2G:2U
HARQ	Maximum number of HARQ transmissions	4
	RV sequence	0, 2, 3, 1
DM-RS	DM-RS configuration type	1
	DM-RS duration	single-symbol DM-RS
	DM-RS position ( $l_0$ )	2
	Additional DM-RS position	pos1
	Number of DM-RS CDM group(s) without data	1
	DM-RS port(s)	{1000} for Rank 1 tests {1000-1001} for Rank 2 tests
	DM-RS sequence generation	$N_{ID}^0=0$
Time domain resource assignment	PDSCH mapping type	A
	Start symbol	1
	Allocation length	13
Frequency domain resource assignment	RB assignment	Full applicable test bandwidth
PT-RS configuration	Frequency density ( $K_{PT-RS}$ )	2
	Time density ( $L_{PT-RS}$ )	1
PRB bundling size		2
VRB-to-PRB mapping type		Not interleaved
PDSCH & PDSCH DMRS Precoding configuration		Single Panel Type I, Random precoder selection updated per slot, with equal probability of each applicable $i_1, i_2$ combination, and with PRB bundling granularity
Note 1: The same requirements are applicable to TDD with different UL-DL patterns.		
Note 2: SSB, TRS, CSI-RS, and/or other unspecified test parameters with respect to TS 38.101-4 [28] are left up to test implementation, if transmitted or needed.		

#### 11.2.2.2.1.2 Minimum requirements

The throughput shall be equal to or larger than the fraction of maximum throughput for the FRCs stated in table 11.2.2.2.1.2-1, 11.2.2.2.1.2-2 and 11.2.2.2.1.2-3 at the given SNR with the test parameters stated in Table 11.2.2.2.1.1-1.

**Table 11.2.2.2.1.2-1: Minimum requirements for PDSCH with Rank 1, 100 MHz Channel Bandwidth, 120 kHz SCS**

Number of TX antennas	Number of demodulation branches	Propagation conditions and correlation matrix (Annex I)	FRC (Annex A)	Fraction of maximum throughput (%)	SNR (dB)
2	2	TDLA30-75, ULA Low	M-FR2-A.3.1-2	30	2.3
2	2	TDLA30-75, ULA Low	M-FR2-A.3.2-1	70	11.7

**Table 11.2.2.2.1.2-2: Minimum requirements for PDSCH with Rank 2, 50 MHz Channel Bandwidth, 60 kHz SCS**

Number of TX antennas	Number of demodulation branches	Propagation conditions and correlation matrix (Annex I)	FRC (Annex A)	Fraction of maximum throughput (%)	SNR (dB)
2	2	TDLA30-75, ULA Low	M-FR2-A.3.1-1	70	14.3

**Table 11.2.2.2.1.2-3: Minimum requirements for PDSCH with Rank 2, 100 MHz Channel Bandwidth, 120 kHz SCS**

Number of TX antennas	Number of demodulation branches	Propagation conditions and correlation matrix (Annex I)	FRC (Annex A)	Fraction of maximum throughput (%)	SNR (dB)
2	2	TDLA30-75, ULA Low	M-FR2-A.3.1-3	70	14.2
2	2	TDLA30-75, ULA Low	M-FR2-A.3.2-2	70	18.6

## 11.2.2.2.2 Performance requirements for PDCCH

### 11.2.2.2.2.1 General

The receiver characteristics of the PDCCH are determined by the probability of miss-detection of the Downlink Scheduling Grant (Pm-dsg).

**Table: 11.2.2.2.2.1-1 Test parameters for testing PDCCH**

Parameter	Value
Cyclic prefix	Normal
Default TDD UL-DL pattern (Note 1)	3D1S1U, S=10D:2G:2U
DM-RS sequence generation	NID=0
Frequency domain resource allocation for CORESET	Start from RB = 0 with contiguous RB allocation
CCE to REG mapping type	Interleaved
Interleaver size	2 for test with Aggregation level 4 3 for others
REG bundle size	6 for test with Aggregation level 4 2 for others
Shift Index	0
Slots for PDCCH monitoring	Each slot
Number of PDCCH candidates for the tested aggregation level	1
PDCCH Precoding configuration	Single Panel Type I, Random precoder selection updated per slot, with equal probability of each applicable i1, i2 combination with REG bundling granularity for number of Tx larger than 1
Note 1: The same requirements are applicable to TDD with different UL-DL patterns.	
Note 2: SSB, TRS, CSI-RS, and/or other unspecified test parameters with respect to TS 38.101-4 [28] are left up to test implementation, if transmitted or needed	

### 11.2.2.2.2 Minimum requirements

The Pm-dsg shall be equal to or smaller than 1%, for the cases stated in Table 11.2.2.2.2-1 at the given SNR with the test parameters stated in Table 11.2.2.2.1-1.

**Table 11.2.2.2.2-1: Minimum requirements for PDCCH, 100 MHz Channel Bandwidth, 120 kHz SCS**

Antenna configuration	CORESET RB	CORESET duration	Aggregation level	FRC (Annex A)	Propagation conditions and correlation matrix (Annex I)	Pm-dsg (%)	SNR (dB)
1x2	60	1	2	M-FR2-A.3.4-1	TDLA30-75, ULA Low	1	6.4
1x2	60	1	4	M-FR2-A.3.4-2	TDLA30-75, ULA Low	1	2.9
2x2	60	1	8	M-FR2-A.3.4-3	TDLA30-75, ULA Low	1	0.1

## 11.2.3 CSI reporting requirements

### 11.2.3.1 Performance requirements for IAB type 1-O

#### 11.2.3.1.1 Reporting of Channel Quality Indicator (CQI)

Apply the requirements defined in clause 8.2.3.2 for 2Rx.

#### 11.2.3.1.2 Reporting of Precoding Matrix Indicator (PMI)

Apply the requirements defined in clause 8.2.3.3 for 2Rx.

#### 11.2.3.1.3 Reporting of Rank Indicator (RI)

Apply the requirements defined in clause 8.2.3.4 for 2Rx.

### 11.2.3.2 Performance requirements for IAB type 2-O

#### 11.2.3.2.1 General

This clause includes radiated requirements for the reporting of channel state information (CSI).

##### 11.2.3.2.1.1 Void

Void

##### 11.2.3.2.1.2 Common test parameters

Parameters specified in Table 11.2.3.2.1.2-1 are applied for all test cases in this clause unless otherwise stated.

Table 11.2.3.2.1.2-1: Test parameters for CSI test cases

Parameter		Unit	Value
PDSCH transmission scheme			Transmission scheme 1
Duplex Mode			TDD
PTRS <i>epr</i> -Ratio			0
Actual carrier configuration	Offset between Point A and the lowest usable subcarrier on this carrier (Note 3)	RBs	0
	Subcarrier spacing	kHz	120
DL BWP configuration #1	Cyclic prefix		Normal
	RB offset	RBs	0
	Number of contiguous PRB	PRBs	Maximum transmission bandwidth configuration as specified in clause 5.3.2 of TS 38.101-2 [4] for tested channel bandwidth and subcarrier spacing
Active DL BWP index			1
PDSCH configuration	Mapping type		Type A
	$k_0$		0
	Starting symbol (S)		2
	Length (L)		12
	PDSCH aggregation factor		1
	PRB bundling type		Static
	PRB bundling size		2
	Resource allocation type		Type 0
	RBG size		Config2
	VRB-to-PRB mapping type		Non-interleaved
PDSCH DMRS configuration	VRB-to-PRB mapping interleaver bundle size		N/A
	DMRS Type		Type 1
	Number of additional DMRS		1
	DMRS ports indexes		{1000} for Rank1 {1000,1001} for Rank2
	Maximum number of OFDM symbols for DL front loaded DMRS		1
PTRS configuration	Number of PDSCH DMRS CDM group(s) without data		2
	Frequency density ( $K_{PT-RS}$ )		2
	Time density ( $L_{PT-RS}$ )		1
N/ZP CSI-RS for CSI acquisition	Resource Element Offset		2
	Frequency Occupation		Start PRB 0 Number of PRB = BWP size
Redundancy version coding sequence			{0,2,3,1}
Physical signals, channels mapping and precoding			As specified in Annex I.3.1
Note 1:	PDSCH is scheduled only on full DL slots without CSI-RS resource and TRS allocated.		
Note 2:	Point A coincides with minimum guard band as specified in Table 5.3.3-1 from TS 38.101-2 [4] for tested channel bandwidth and subcarrier spacing.		

## 11.2.3.2.2 Reporting of Channel Quality Indicator (CQI)

## 11.2.3.2.2.1 General

The reporting accuracy of the channel quality indicator (CQI) under frequency non-selective conditions is determined by the reporting variance and the BLER performance using the transport format indicated by the reported CQI median. The purpose is to verify that the reported CQI values are in accordance with the CQI definition given in TS 38.214 [11]. To account for sensitivity of the input SNR the reporting definition is considered to be verified if the reporting accuracy is met for at least one of two SNR levels separated by an offset of 1 dB.

Table 11.2.3.2.2.1-1: Test parameters

Parameter		Unit	Test 1	Test 2
Bandwidth		MHz	100	
Subcarrier spacing		kHz	120	
Duplex Mode			TDD	
Default TDD UL-DL pattern (Note 1)			3D1S1U	
Special Slot Configuration			10D+2G+2U	
SNR <sub>BB</sub>		dB	8	9   14   15
Propagation channel			AWGN	
Antenna configuration			2x2 with static channel specified in Annex I.1	
Beamforming Model			As specified in Annex I.3.1	
NZP CSI-RS for CSI acquisition	CSI-RS resource Type		<i>Periodic</i>	
	Number of CSI-RS ports ( $X$ )		2	
	CDM Type		<i>fd-CDM2</i>	
	Density ( $\rho$ )		1	
	First subcarrier index in the PRB used for CSI-RS ( $k_0, k_1$ )		6	
	First OFDM symbol in the PRB used for CSI-RS ( $l_0, l_1$ )		13	
	NZP CSI-RS-timeConfig periodicity and offset	slot	5/1	
ReportConfigType			<i>Periodic</i>	
CQI-table			Table 1	
reportQuantity			<i>cri-RI-PMI-CQI</i>	
cqi-FormatIndicator			<i>Wideband</i>	
pmi-FormatIndicator			<i>Wideband</i>	
Sub-band Size		RB	8	
csi-ReportingBand			111111111	
CSI-Report periodicity and offset		slot	5/4	
Codebook configuration	Codebook Type		<i>type1-SinglePanel</i>	
	Codebook Mode		1	
	(CodebookConfig-N1, CodebookConfig-N2)		<i>Not configured</i>	
	CodebookSubsetRestriction		010000	
	RI Restriction		N/A	
CQI/RI/PMI delay		ms	1.75	
Maximum number of HARQ transmission			1	
Measurement channel			M-FR2-A.3.5-2	
Note 1: The same requirements are applicable to with different UL-DL patterns.				
Note 2: SSB, TRS, CSI-RS, and/or other unspecified test parameters with respect to TS 38.101-4 [28] are left up to test implementation, if transmitted or needed.				
Note 3: If the IAB-MT reports in an available uplink reporting instance at slot #n based on CQI estimation at a downlink slot not later than slot#(n-4), this reported CQI cannot be applied at the gNB downlink before slot#(n+4).				

## 11.2.3.2.2.2 Minimum requirements

For the parameters specified in Table 11.2.3.2.1.1-1, and using the downlink physical channels specified in Annex A, the minimum requirements are specified by the following:

- a) The reported CQI value according to the reference channel shall be in the range of  $\pm 1$  of the reported median more than 90% of the time.
- b) If the PDSCH BLER using the transport format indicated by median CQI is less than or equal to 0.1, then the BLER using the transport format indicated by the (median CQI+1) shall be greater than 0.1. If the PDSCH BLER using the transport format indicated by the median CQI is greater than 0.1, then the BLER using transport format indicated by (median CQI-1) shall be less than or equal to 0.1.

### 11.2.3.2.3 Reporting of Precoding Matrix Indicator (PMI)

#### 11.2.3.2.3.1 General

The minimum performance requirements of PMI reporting are defined based on the precoding gain, expressed as the relative increase in throughput when the transmitter is configured according to the IAB-MT reports compared to the case when the transmitter is using random precoding, respectively. When the transmitter uses random precoding, for each PDSCH allocation a precoder is randomly generated and applied to the PDSCH. A fixed transport format (FRC) is configured for all requirements.

The requirements for transmission mode 1 with 2TX and higher layer parameter *codebookType* set to 'typeI-SinglePanel' are specified in terms of the ratio

$$\gamma = \frac{t_{ue}}{t_{rnd}}$$

In the definition of  $\gamma$ , for 2TX PMI requirements,  $t_{ue}$  is 90 % of the maximum throughput obtained at  $SNR_{ue}$  using the precoders configured according to the IAB-MT reports, and  $t_{rnd}$  is the throughput measured at  $SNR_{ue}$  with random precoding.



Table 11.2.3.2.3.1-1: Test parameters

Parameter		Unit	Test 1
Bandwidth		MHz	100
Subcarrier spacing		kHz	120
Default TDD UL-DL pattern (Note 1)			3D1S1U
Special Slot Configuration			10D+2G+2U
Propagation channel			TDLA30-35
Antenna configuration			2 x 2 ULA Low
Beamforming Model			As specified in Annex I.3.1
NZIP CSI-RS for CSI acquisition	CSI-RS resource Type		Periodic
	Number of CSI-RS ports ( $X$ )		2
	CDM Type		FD-CDM2
	Density ( $\rho$ )		1
	First subcarrier index in the PRB used for CSI-RS ( $k_0, k_1$ )		Row 3, (6,-)
	First OFDM symbol in the PRB used for CSI-RS ( $l_0, l_1$ )		(13,-)
	CSI-RS interval and offset	slot	5/1
ReportConfigType			Periodic
CQI-table			Table 1
reportQuantity			cri-RI-PMI-CQI
cqi-FormatIndicator			Wideband
pmi-FormatIndicator			Wideband
Sub-band Size		RB	8
csi-ReportingBand			111111111
CSI-Report interval and offset		slot	5/4
Codebook configuration	Codebook Type		type1-SinglePanel
	Codebook Mode		1
	(CodebookConfig-N1, CodebookConfig-N2)		N/A
	CodebookSubsetRestriction		001111
	RI Restriction		N/A
CQI/RI/PMI delay		ms	1.75
Maximum number of HARQ transmission			4
Measurement channel			M-FR2-A.3.5-3
<p>Note 1: The same requirements are applicable for TDD with different UL-DL pattern.</p> <p>Note 2: For random precoder selection, the precoder shall be updated in each slot (0.125 ms granularity).</p> <p>Note 3: If the IAB-MT reports in an available uplink reporting instance at slot #n based on PMI estimation at a downlink slot not later than slot#(n-4), this reported PMI cannot be applied at the gNB downlink before slot#(n+4).</p> <p>Note 4: Randomization of the principle beam direction shall be used as specified in Annex I.2.3.2.3.</p> <p>Note 5: SSB, TRS, CSI-RS and/or other unspecified test parameters with respect to TS 38.101-4 [28] are left up to test implementation, if transmitted or needed</p>			

### 11.2.3.2.3.2 Minimum requirements

For the parameters specified in Table 11.2.3.2.3.1-1, and using the downlink physical channels specified in Annex A, the minimum requirements are specified in Table 11.2.3.2.3.2-1.

**Table 11.2.3.2.3.2-1: Minimum requirement**

Parameter	Test 1
$\gamma$	1.05

### 11.2.3.2.4 Reporting of Rank Indicator (RI)

#### 11.2.3.2.4.1 General

The purpose of this test is to verify that the reported rank indicator accurately represents the channel rank. The accuracy of RI reporting is determined by the relative increase of the throughput obtained when transmitting based on the reported rank compared to the case for which a fixed rank is used for transmission.

The minimum performance requirement in Table 11.2.3.2.4.2-1 is defined as

- a) The ratio of the throughput obtained when transmitting based on IAB-MT reported RI and that obtained when transmitting with fixed rank 1 shall be  $\geq \gamma_1$ ;
- b) The ratio of the throughput obtained when transmitting based on IAB-MT reported RI and that obtained when transmitting with fixed rank 2 shall be  $\geq \gamma_2$ ;

Table 11.2.3.2.4.1-1: Test parameters

Parameter		Unit	Test 1	Test 2	Test 3
Bandwidth		MHz	100	100	100
Subcarrier spacing		kHz	120	120	120
Duplex Mode			TDD	TDD	TDD
Default TDD UL-DL pattern (Note 1)			3D1S1U	3D1S1U	3D1S1U
Special Slot Configuration			10D+2G+2U	10D+2G+2U	10D+2G+2U
SNR		dB	0	16	16
Propagation channel			TDLA30-35	TDLA30-35	TDLA30-35
Antenna configuration			ULA Low 2x2	ULA Low 2x2	XP High 2x2
Beamforming Model			As defined in Annex I.3.1	As defined in Annex I.3.1	As defined in Annex I.3.1
NZIP CSI-RS for CSI acquisition	CSI-RS resource Type		Periodic	Periodic	Periodic
	Number of CSI-RS ports ( $X$ )		2	2	2
	CDM Type		FD-CDM2	FD-CDM2	FD-CDM2
	Density ( $\rho$ )		1	1	1
	First subcarrier index in the PRB used for CSI-RS ( $k_0, k_1$ )		Row 3 (6,-)	Row 3 (6,-)	Row 3 (6,-)
	First OFDM symbol in the PRB used for CSI-RS ( $l_0, l_1$ )		(13,-)	(13,-)	(13,-)
	NZIP CSI-RS-timeConfig interval and offset	slot	5/1	5/1	5/1
ReportConfigType		Periodic	Periodic	Periodic	
CQI-table		Table 1	Table 1	Table 1	
reportQuantity		cri-RI-PMI-CQI	cri-RI-PMI-CQI	cri-RI-PMI-CQI	
cqi-FormatIndicator		Wideband	Wideband	Wideband	
pmi-FormatIndicator		Wideband	Wideband	Wideband	
Sub-band Size	RB	8	8	8	
csi-ReportingBand		111111111	111111111	111111111	
CSI-Report interval and offset	slot	5/4	5/4	5/4	
Codebook configuration	Codebook Type		typel-SinglePanel	typel-SinglePanel	typel-SinglePanel
	Codebook Mode		1	1	1
	(CodebookConfig-N1, CodebookConfig-N2)		N/A	N/A	N/A
	CodebookSubsetRestriction		010000 for fixed rank 2, 010011 for following rank	000011 for fixed rank 1, 010011 for following rank	000011 for fixed rank 1, 010011 for following rank
	RI Restriction		N/A	N/A	N/A
CQI/RI/PMI delay	ms	1.75	1.75	1.75	
Maximum number of HARQ transmission		1	1	1	
RI Configuration		Fixed RI = 2 and follow RI	Fixed RI = 1 and follow RI	Fixed RI = 1 and follow RI	
Note 1: The same requirements are applicable to with different UL-DL patterns.					
Note 2: SSB, TRS, CSI-RS and/or other unspecified test parameters with respect to TS 38.101-4 [28] are left up to test implementation, if transmitted or needed.					
Note 3: Measurements channels are specified in Table A.3.5-2. M-FR2-A.3.5-1 is used for Rank 1 case. M-FR2-A.3.5-2 is used for Rank 2 case.					
Note 4: If the IAB-MT reports in an available uplink reporting instance at slot #n based on RI estimation at a downlink slot not later than slot#(n-4), this reported RI cannot be applied at the gNB downlink before slot#(n+4).					

## 11.2.3.2.4.2 Minimum requirements

For the parameters specified in Table 11.2.3.2.4.1-1, and using the downlink physical channels specified in Annex A, the minimum requirements are specified in Table 11.2.3.2.4.2-1.

Table 11.2.3.2.4.2-1: Minimum requirement

	Test 1	Test 2	Test 3
$\gamma_1$	N/A	1.05	1.05
$\gamma_2$	1.0	N/A	N/A

## 12 Radio Resource Management requirements

### 12.1 RRC\_CONNECTED state mobility for IAB-MTs

#### 12.1.1 RRC Connection Mobility Control

##### 12.1.1.1 SA: RRC Re-establishment

###### 12.1.1.1.1 Introduction

This clause contains requirements on the IAB-MT regarding RRC connection re-establishment procedure. RRC connection re-establishment is initiated when an IAB-MT in RRC\_CONNECTED state loses RRC connection due to any of failure cases, including radio link failure, handover failure, and RRC connection reconfiguration failure. The RRC connection re-establishment procedure is specified in clause 5.3.7 of TS 38.331 [15].

The requirements in this clause are applicable for RRC connection re-establishment to NR cell.

###### 12.1.1.1.2 Requirements

In RRC\_CONNECTED state the IAB-MT shall be capable of sending *RRCReestablishmentRequest* message within  $T_{re-establish\_delay}$  seconds from the moment it detects a loss in RRC connection. The total RRC connection delay ( $T_{re-establish\_delay}$ ) shall be less than:

$$T_{re-establish\_delay} = T_{IAB-MT\_re-establish\_delay} + T_{UL\_grant}$$

$T_{UL\_grant}$ : It is the time required to acquire and process uplink grant from the target PCell. The uplink grant is required to transmit *RRCReestablishmentRequest* message.

The IAB-MT re-establishment delay ( $T_{IAB-MT\_re-establish\_delay}$ ) is specified in clause 12.1.1.1.2.1.

###### 12.1.1.1.2.1 IAB MT Re-establishment delay requirement

The IAB-MT re-establishment delay ( $T_{IAB-MT\_re-establish\_delay}$ ) is the time between the moments when any of the conditions requiring RRC re-establishment as defined in clause 5.3.7 in TS 38.331 [15] is detected by the IAB-MT and when the IAB-MT sends PRACH to the target PCell. The IAB-MT re-establishment delay ( $T_{IAB-MT\_re-establish\_delay}$ ) requirement shall be less than:

$$T_{IAB-MT\_re-establish\_delay} = 400 \text{ ms} + T_{identify\_intra\_NR} + \sum_{i=1}^{N_{freq}-1} T_{identify\_inter\_NR,i} + T_{SI-NR} + T_{PRACH}$$

The intra-frequency target NR cell shall be considered detectable if each relevant SSB can satisfy that:

- the conditions of SSB<sub>RP</sub> and SSB  $\hat{E}_s/I_{ot}$  according to Annex H.1.1.1 for a corresponding IAB-MT class and IAB type are fulfilled.

The inter-frequency target NR cell shall be considered detectable when for each relevant SSB:

- the conditions of SSB<sub>RP</sub> and SSB  $\hat{E}_s/I_{ot}$  according to Annex H.1.1.2 for a corresponding IAB-MT class and IAB type are fulfilled.

$T_{identify\_intra\_NR}$ : It is the time to identify the target intra-frequency NR cell and it depends on whether the target NR cell is known cell or unknown cell and on the frequency range (FR) of the target NR cell. If the IAB-MT is not configured

with intra-frequency NR carrier for RRC re-establishment then  $T_{\text{identify\_intra\_NR}}=0$ ; otherwise  $T_{\text{identify\_intra\_NR}}$  shall not exceed the values defined in Table 12.1.1.1.2.1-1.

$T_{\text{identify\_inter\_NR},i}$ : It is the time to identify the target inter-frequency NR cell on inter-frequency carrier  $i$  configured for RRC re-establishment and it depends on whether the target NR cell is known cell or unknown cell and on the frequency range (FR) of the target NR cell.  $T_{\text{identify\_inter\_NR},i}$  shall not exceed the values defined in Table 12.1.1.1.2.1-2.

$T_{\text{SMTC}}$ : It is the periodicity of the SMTC occasion configured for the intra-frequency carrier. If the IAB-MT has been provided with higher layer signaling of  $\text{smtc2}$  [15] and is not capable of 4 SMTC configurations per frequency [15], then  $T_{\text{SMTC}}$  follows  $\text{smtc1}$  or  $\text{smtc2}$  according to the physical cell ID of the target cell. If the IAB-MT has been provided with higher layer signaling of  $\text{smtc}j$ , where  $1 \leq j \leq 4$  [15] and is also capable of 4 SMTC configurations per frequency [15], then  $T_{\text{SMTC}}$  follows  $\text{smtc}j$  according to the physical cell ID of the target cell.

$T_{\text{SMTC},i}$ : It is the periodicity of the SMTC occasion configured for the inter-frequency carrier  $i$ . If the IAB-MT is not capable of 4 SMTC configurations per frequency [15], then the requirements shall apply provided that the IAB-MT is configured with only one SMTC configuration for each inter-frequency carrier  $i$  according to the physical cell ID of the target cell. If the IAB-MT has been provided with higher layer signaling of  $\text{smtc}j$ , where  $1 \leq j \leq 4$  [15] and is also capable of 4 SMTC configurations per frequency [15], then  $T_{\text{SMTC}}$  follows  $\text{smtc}j$  configured for the inter-frequency carrier  $i$  according to the physical cell ID of the target cell. If the IAB-MT is not provided with SMTC configuration then the IAB-MT may assume that the target SSB periodicity is no larger than 160 ms.

$T_{\text{SI-NR}}$ : It is the time required for receiving all the relevant system information according to the reception procedure and the RRC procedure delay of system information blocks defined in TS 38.331 [15] for the target NR cell.

$T_{\text{PRACH}}$ : It is the delay uncertainty in acquiring the first available PRACH occasion in the target NR cell.  $T_{\text{PRACH}}$  can be up to the summation of SSB to PRACH occasion association period and 10 ms. SSB to PRACH occasion associated period is defined in clause 14 of TS 38.213 [10].

$N_{\text{freq}}$ : It is the total number of NR frequencies to be monitored for RRC re-establishment;  $N_{\text{freq}} = 1$  if the target intra-frequency NR cell is known, else  $N_{\text{freq}} = 2$  and  $T_{\text{identify\_intra\_NR}} = 0$  if the target inter-frequency NR cell is known.

There is no requirement if the target cell does not contain the IAB-MT context or if the SSB transmission periodicity is larger than 160 ms.

In the requirement defined in the below tables, the target FR1 cell is known if it has been meeting the relevant cell identification requirement during the last 5 seconds otherwise it is unknown.

**Table 12.1.1.1.2.1-1: Time to identify target NR cell for RRC connection re-establishment to NR intra-frequency cell**

Serving cell SSB $\hat{E}_s/\text{lot}$ (dB)	Frequency range (FR) of target NR cell	$T_{\text{identify\_intra\_NR}}$ [ms]	
		Known NR cell	Unknown NR cell
$\geq -8$	FR1	MAX (1600 ms, $5 \times T_{\text{SMTC}}$ )	MAX (6400 ms, $10 \times T_{\text{SMTC}}$ )
$\geq -8$	FR2-1	N/A	MAX (8000 ms, $80 \times T_{\text{SMTC}}$ )
$< -8$	FR1	N/A	6400 <sup>Note1</sup>
$< -8$	FR2-1	N/A	28160 <sup>Note1</sup>

Note 1: The IAB-MT is not required to successfully identify a cell on any NR frequency layer when  $T_{\text{SMTC}} > 160$  ms and serving cell SSB  $\hat{E}_s/\text{lot} < -8$  dB.

**Table 12.1.1.1.2.1-2: Time to identify target NR cell for RRC connection re-establishment to NR inter-frequency cell**

Serving cell SSB $\hat{E}_s/\text{lot}$ (dB)	Frequency range (FR) of target NR cell	$T_{\text{identify\_inter\_NR}, i}$ [ms]	
		Known NR cell	Unknown NR cell
$\geq -8$	FR1	MAX (1600 ms, $6 \times T_{\text{SMTC}, i}$ )	MAX (6400 ms, $13 \times T_{\text{SMTC}, i}$ )
$\geq -8$	FR2-1	N/A	MAX (8000 ms, $104 \times T_{\text{SMTC}, i}$ )
$< -8$	FR1	N/A	6400 <sup>Note1</sup>
$< -8$	FR2-1	N/A	32000 <sup>Note1</sup>

Note 1: The IAB-MT is not required to successfully identify a cell on any NR frequency layer when  $T_{\text{SMTC}, i} > 160$  ms and serving cell SSB  $\hat{E}_s/\text{lot} < -8$  dB.

### 12.1.1.2 Random access

The requirements in clause 6.2.2 in TS 38.133 [6] apply for IAB-MT.

### 12.1.1.3 SA: RRC Connection Release with Redirection

#### 12.1.1.3.1 Introduction

This clause contains requirements on the IAB-MT regarding RRC connection release with redirection procedure. RRC connection release with redirection is initiated by the *RRCRelease* message with redirection to NR from NR specified in TS 38.331 [15]. The RRC connection release with redirection procedure is specified in clause 5.3.8 of TS 38.331 [15].

#### 12.1.1.3.2 Requirements

##### 12.1.1.3.2.1 RRC connection release with redirection to NR

The IAB-MT shall be capable of performing the RRC connection release with redirection to the target NR cell within  $T_{\text{connection\_release\_redirect\_NR}}$ .

The time delay ( $T_{\text{connection\_release\_redirect\_NR}}$ ) is the time between the end of the last slot containing the RRC command, “*RRCRelease*” (TS 38.331 [15]) on the NR PDSCH and the time the IAB-MT starts to send random access to the target NR cell. The time delay ( $T_{\text{connection\_release\_redirect\_NR}}$ ) shall be less than:

$$T_{\text{connection\_release\_redirect\_NR}} = T_{\text{RRC\_procedure\_delay}} + T_{\text{identify\_NR}} + T_{\text{SI-NR}} + T_{\text{RACH}}$$

The target NR cell shall be considered detectable when for each relevant SSB, the side conditions should be met that,

- the conditions of SSB<sub>RP</sub> and SSB  $\hat{E}_s/\text{lot}$  according to Annex H.1.1.3 for a corresponding IAB-MT class and IAB type are fulfilled.

$T_{\text{RRC\_procedure\_delay}}$ : It is the RRC procedure delay for processing the received message “*RRCRelease*” as defined in clause 6.2.2 of TS 38.331 [15].

$T_{\text{identify\_NR}}$ : It is the time to identify the target NR cell and depends on the frequency range (FR) of the target NR cell. It is defined in Table 12.1.1.3.2-1. Note that  $T_{\text{identify\_NR}} = T_{\text{PSS/SSS-sync}} + T_{\text{meas}}$ , in which  $T_{\text{PSS/SSS-sync}}$  is the cell search time and  $T_{\text{meas}}$  is the measurement time due to cell selection criteria evaluation.

$T_{\text{SI-NR}}$ : It is the time required for acquiring all the relevant system information of the target NR cell. This time depends upon whether the IAB-MT is provided with the relevant system information of the target NR cell or not by the old NR cell before the RRC connection is released.

$T_{\text{RACH}}$ : It is the delay uncertainty in acquiring the first available PRACH occasion in the target NR cell.  $T_{\text{RACH}}$  can be up to the summation of SSB to PRACH occasion association period and 10 ms. SSB to PRACH occasion associated period is defined in clause 14 of TS 38.213 [10].

$T_{\text{rs}}$  is the SMTC periodicity of the target NR cell if the IAB-MT has been provided with an SMTC configuration for the target cell in the redirection command, otherwise  $T_{\text{rs}}$  is the SMTC periodicity configured in the *measObjectNR* having the same SSB frequency and subcarrier spacing configured for the RRC connection release with redirection. If the IAB-

MT is not capable of 4 SMTC configurations per frequency [15], then the requirements shall apply provided that the IAB-MT is configured with only one SMTC configuration on carrier configured for RRC connection release with redirection. If the IAB-MT has been provided with higher layer signaling of  $smtcj$ , where  $1 \leq j \leq 4$  [15] and is also capable of 4 SMTC configurations per frequency [15], then  $T_{smtc}$  follows  $smtcj$  according to the physical cell ID of the target cell. If the IAB-MT is not provided with SMTC configuration or measurement object for the frequency which is also configured for the RRC connection release with redirection then the requirement in this clause is applied with  $T_{rs} = 160$  ms if the SSB transmission periodicity is not larger than 160 ms.

- There is no requirement if the SSB transmission periodicity is larger than 160ms.

**Table 12.1.1.3.2-1: Time to identify target NR cell for RRC connection release with redirection to NR**

Frequency range (FR) of target NR cell	$T_{\text{identify-NR}}$
FR1	MAX (5440 ms, $11 \times T_{rs}$ )
FR2-1	MAX (7040 ms, $8 \times 11 \times T_{rs}$ )

## 12.2 Timing

### 12.2.1 IAB-MT transmit timing

#### 12.2.1.1 Introduction

The IAB-MT shall have capability to follow the frame timing change of the reference cell in connected state. The uplink frame transmission takes place  $(N_{TA} + N_{TA\text{ offset}}) \times T_c$  before the reception of the first detected path (in time) of the corresponding downlink frame from the reference cell. IAB-MT belonging to local area IAB-MT class as defined in clause 4.4.2 and also capable of carrier aggregation shall use the SpCell as the reference cell for deriving the IAB-MT transmit timing for cells in the PTAG. IAB-MT initial transmit timing accuracy, gradual timing adjustment requirements are defined in the following requirements. The requirements apply when the indicated IAB-MT transmission timing mode is set to 'Case 1' specified in clause 14 of TS 38.213 [10].

#### 12.2.1.2 Requirements

The IAB-MT initial transmission timing error shall be less than or equal to  $\pm T_e$  where the timing error limit value  $T_e$  is specified in Table 12.2.1.2-1. This requirement applies for PUCCH, PUSCH and SRS or it is the PRACH transmission.

The IAB-MT shall meet the  $T_e$  requirement for an initial transmission provided that at least one SSB is available at the IAB-MT during the last 160 ms. The reference point for the IAB-MT initial transmit timing control requirement shall be the downlink timing of the reference cell minus  $(N_{TA} + N_{TA\text{ offset}}) \times T_c$ . The downlink timing is defined as the time when the first path (in time) of the corresponding downlink frame used by the IAB-MT to determine downlink timing is received from the reference cell at the IAB-MT antenna.  $N_{TA}$  for PRACH is defined as 0.

$(N_{TA} + N_{TA\text{ offset}}) \times T_c$  (in  $T_c$  units) for other channels is the difference between IAB-MT transmission timing and the downlink timing immediately after when the last timing advance in clause 12.2.2 was applied.  $N_{TA}$  for other channels is not changed until next timing advance is received. The value of  $N_{TA\text{ offset}}$  depends on the duplex mode of the cell in which the uplink transmission takes place and the frequency range (FR).  $N_{TA\text{ offset}}$  is defined in Table 12.2.1.2-2.

Table 12.2.1.2-1:  $T_e$  Timing Error Limit

Frequency Range	SCS of SSB signals ( kHz)	SCS of uplink signals ( kHz)	$T_e$
1	15	15	$12 \cdot 64 \cdot T_c$
		30	$10 \cdot 64 \cdot T_c$
		60	$10 \cdot 64 \cdot T_c$
	30	15	$8 \cdot 64 \cdot T_c$
		30	$8 \cdot 64 \cdot T_c$
		60	$7 \cdot 64 \cdot T_c$
FR2-1	120	60	$3.5 \cdot 64 \cdot T_c$
		120	$3.5 \cdot 64 \cdot T_c$
	240	60	$3 \cdot 64 \cdot T_c$
		120	$3 \cdot 64 \cdot T_c$
Note 1: $T_c$ is the basic timing unit defined in TS 38.211 [8]			

Table 12.2.1.2-2: The Value of  $N_{TA\ offset}$ 

Frequency range and band of cell used for uplink transmission	$N_{TA\ offset}$ (Unit: $T_c$ )
FR1 TDD band without LTE-NR coexistence case	25600 (Note 1)
FR1 TDD band with LTE-NR coexistence case	39936 (Note 1)
FR2-1	13792
Note 1: The IAB-MT identifies $N_{TA\ offset}$ based on the information n-TimingAdvanceOffset as specified in TS 38.331 [15]. If IAB-MT is not provided with the information n-TimingAdvanceOffset, the default value of $N_{TA\ offset}$ is set as 25600 for FR1 band.	

When it is the transmission for PUCCH, PUSCH and SRS transmission, the IAB-MT shall be capable of changing the transmission timing according to the received downlink frame of the reference cell except when the timing advance in clause 12.2.3 is applied.

#### 12.2.1.2.1 Gradual timing adjustment

When the transmission timing error between the IAB-MT and the reference timing exceeds  $\pm T_e$  then the IAB-MT is required to adjust its timing to within  $\pm T_e$ . The reference timing shall be  $(N_{TA} + N_{TA\ offset}) \cdot T_c$  before the downlink timing of the reference cell. All adjustments made to the IAB-MT uplink timing shall follow these rules:

- 1) The maximum amount of the magnitude of the timing change in one adjustment shall be  $T_q$ .
- 2) The minimum aggregate adjustment rate shall be  $T_p$  per second.
- 3) The maximum aggregate adjustment rate shall be  $T_q$  per 200 ms.

where the maximum autonomous time adjustment step  $T_q$  and the aggregate adjustment rate  $T_p$  are specified in Table 12.2.1.2.1-1.

Table 12.2.1.2.1-1:  $T_q$  Maximum Autonomous Time Adjustment Step and  $T_p$  Minimum Aggregate Adjustment rate

Frequency Range	SCS of uplink signals (kHz)	$T_q$	$T_p$
1	15	$5.5 \cdot 64 \cdot T_c$	$5.5 \cdot 64 \cdot T_c$
	30	$5.5 \cdot 64 \cdot T_c$	$5.5 \cdot 64 \cdot T_c$
	60	$5.5 \cdot 64 \cdot T_c$	$5.5 \cdot 64 \cdot T_c$
2	60	$2.5 \cdot 64 \cdot T_c$	$2.5 \cdot 64 \cdot T_c$
	120	$2.5 \cdot 64 \cdot T_c$	$2.5 \cdot 64 \cdot T_c$
NOTE: $T_c$ is the basic timing unit defined in TS 38.211 [8]			



## 12.2.2 Void

## 12.2.3 IAB-MT timing advance

### 12.2.3.1 Timing Advance adjustment delay

The IAB-MT shall adjust the timing of its uplink transmission timing at time slot  $n+k+1$  for a timing advance command received in time slot  $n$ , and the value of  $k$  is defined in clause 4.2 in TS 38.213 [10]. The requirements in this clause apply for IAB-MT, for 'Case 1' transmission timing mode specified in clause 14 of TS 38.213 [10].

### 12.2.3.2 Timing Advance adjustment accuracy

The IAB-MT shall adjust the timing of its transmissions with a relative accuracy better than or equal to the IAB-MT Timing Advance adjustment accuracy requirement in Table 12.2.3-1, to the signalled timing advance value compared to the timing of preceding uplink transmission. The timing advance command step is defined in TS 38.213 [10].

**Table 12.2.3.2-1: UE Timing Advance adjustment accuracy**

UL Sub Carrier Spacing(kHz)	15	30	60	120
UE Timing Advance adjustment accuracy	$\pm 256 T_c$	$\pm 256 T_c$	$\pm 128 T_c$	$\pm 32 T_c$

## 12.2.4 Cell phase synchronization accuracy

### 12.2.4.1 Introduction

Cell phase synchronization accuracy for TDD is defined as the maximum absolute deviation in frame start timing between any pair of cells on the same frequency that have overlapping coverage areas.

### 12.2.4.2 Requirements

The cell phase synchronization accuracy measured at IAB DU TAB connectors or RIBs shall be better than 3  $\mu$ s.

## 12.3 Signalling Characteristics for IAB MTs

### 12.3.1 Radio Link Monitoring

#### 12.3.1.1 Introduction

The UE requirements in sub-clause 8.1.1 [6] apply for IAB-MT.

#### 12.3.1.2 Requirements for SSB based radio link monitoring

##### 12.3.1.2.1 Introduction

The requirements in this clause apply for each SSB based RLM-RS resource configured for PCell, provided that the SSB configured for RLM is actually transmitted within IAB-MT active DL BWP during the entire evaluation period specified in clause 12.3.1.2.2.

**Table 12.3.1.2.1-1: PDCCH transmission parameters for out-of-sync evaluation**

Attribute	Value for BLER Configuration #0
DCI format	1-0
Number of control OFDM symbols	2
Aggregation level (CCE)	8
Ratio of hypothetical PDCCH RE energy to average SSS RE energy	4dB
Ratio of hypothetical PDCCH DMRS energy to average SSS RE energy	4dB
Bandwidth (PRBs)	24
Sub-carrier spacing (kHz)	SCS of the active DL BWP
DMRS precoder granularity	REG bundle size
REG bundle size	6
CP length	Normal
Mapping from REG to CCE	Distributed

**Table 12.3.1.2.1-2: PDCCH transmission parameters for in-sync evaluation**

Attribute	Value for BLER Configuration #0
DCI payload size	1-0
Number of control OFDM symbols	2
Aggregation level (CCE)	4
Ratio of hypothetical PDCCH RE energy to average SSS RE energy	0dB
Ratio of hypothetical PDCCH DMRS energy to average SSS RE energy	0dB
Bandwidth (PRBs)	24
Sub-carrier spacing (kHz)	SCS of the active DL BWP
DMRS precoder granularity	REG bundle size
REG bundle size	6
CP length	Normal
Mapping from REG to CCE	Distributed

### 12.3.1.2.2 Minimum requirement

IAB-MT shall be able to evaluate whether the downlink radio link quality on the configured RLM-RS resource estimated over the last  $T_{\text{Evaluate\_out\_SSB}}$  [ms] period becomes worse than the threshold  $Q_{\text{out\_SSB}}$  within  $T_{\text{Evaluate\_out\_SSB}}$  [ms] evaluation period.

IAB-MT shall be able to evaluate whether the downlink radio link quality on the configured RLM-RS resource estimated over the last  $T_{\text{Evaluate\_in\_SSB}}$  [ms] period becomes better than the threshold  $Q_{\text{in\_SSB}}$  within  $T_{\text{Evaluate\_in\_SSB}}$  [ms] evaluation period.

$T_{\text{Evaluate\_out\_SSB}}$  and  $T_{\text{Evaluate\_in\_SSB}}$  are defined in Table 12.3.1.2.2-1 for FR1 with scaling factor  $K_1 = 5$ .

$T_{\text{Evaluate\_out\_SSB}}$  and  $T_{\text{Evaluate\_in\_SSB}}$  are defined in Table 12.3.1.2.2-2 for FR2-1 with scaling factor  $N=8$  and  $K_2 = 3$ .

For FR1,

- $P = 1$

For FR2-1,

- $P=1$ , when the RLM-RS resource is not overlapped with SMTC occasion.

- $P = \frac{1}{1 - \frac{T_{SSB}}{T_{SMTCperiod}}}$ , when the RLM-RS resource is partially overlapped with SMTC occasion ( $T_{SSB} < T_{SMTCperiod}$ ).
- $P = 3$ , when RLM-RS resource is fully overlapped with SMTC period ( $T_{SSB} = T_{SMTCperiod}$ ).

If the IAB-MT is not capable of 4 SMTC configurations per frequency [15], and is provided with higher layer signaling of  $smtcj$ , where  $1 \leq j \leq 2$  [15], then  $T_{SMTCperiod}$  follows  $smtcj_{max}$  where  $j_{max}$  is the maximum value of all  $j$  for which  $smtcj$  has been configured.

If the IAB-MT is capable of 4 SMTC configurations per frequency [15], and is provided with higher layer signaling of  $smtcj$ , where  $1 \leq j \leq 4$  [15], then  $T_{SMTCperiod}$  follows  $smtcj_{max}$  where  $j_{max}$  is the maximum value of all  $j$  for which  $smtcj$  has been configured.

Longer evaluation period would be expected if the combination of RLM-RS resource and SMTC occasion configurations does not meet previous conditions.

**Table 12.3.1.2.2-1: Evaluation period  $T_{Evaluate\_out\_SSB}$  and  $T_{Evaluate\_in\_SSB}$  for FR1**

Configuration	$T_{Evaluate\_out\_SSB}$ (ms)	$T_{Evaluate\_in\_SSB}$ (ms)
no DRX	$\text{Max}(200 \times K_1, \text{Ceil}(10 \times P \times K_1) \times T_{SSB})$	$\text{Max}(100 \times K_1, \text{Ceil}(5 \times P \times K_1) \times T_{SSB})$
NOTE: $T_{SSB}$ is the periodicity of the SSB configured for RLM.		

**Table 12.3.1.2.2-2: Evaluation period  $T_{Evaluate\_out\_SSB}$  and  $T_{Evaluate\_in\_SSB}$  for FR2-1**

Configuration	$T_{Evaluate\_out\_SSB}$ (ms)	$T_{Evaluate\_in\_SSB}$ (ms)
no DRX	$\text{Max}(200 \times K_2, \text{Ceil}(10 \times P \times N \times K_2) \times T_{SSB})$	$\text{Max}(100 \times K_2, \text{Ceil}(5 \times P \times N \times K_2) \times T_{SSB})$
NOTE: $T_{SSB}$ is the periodicity of the SSB configured for RLM.		

### 12.3.1.2.3 Measurement restrictions for SSB based RLM

The UE requirements in sub-clause 8.1.2.3 [6] apply for IAB-MT.

### 12.3.1.3 Requirements for CSI-RS based radio link monitoring

#### 12.3.1.3.1 Introduction

The requirements in this clause apply for each CSI-RS based RLM-RS resource configured for PCell, provided that the CSI-RS configured for RLM is actually transmitted within IAB-MT active DL BWP during the entire evaluation period specified in clause 12.3.1.3.2. IAB-MT is not expected to perform radio link monitoring measurements on the CSI-RS configured as RLM-RS if the CSI-RS is not in the active TCI state of any CORESET configured in the IAB-MT active BWP.

**Table 12.3.1.3.1-1: PDCCH transmission parameters for out-of-sync evaluation**

Attribute	Value for BLER Configuration #0
DCI format	1-0
Number of control OFDM symbols	2
Aggregation level (CCE)	8
Ratio of hypothetical PDCCH RE energy to average CSI-RS RE energy	4dB
Ratio of hypothetical PDCCH DMRS energy to average CSI-RS RE energy	4dB
Bandwidth (PRBs)	48
Sub-carrier spacing (kHz)	SCS of the active DL BWP
DMRS precoder granularity	REG bundle size
REG bundle size	6
CP length	Normal
Mapping from REG to CCE	Distributed

**Table 12.3.1.3.1-2: PDCCH transmission parameters for in-sync evaluation**

Attribute	Value for BLER Configuration #0
DCI payload size	1-0
Number of control OFDM symbols	2
Aggregation level (CCE)	4
Ratio of hypothetical PDCCH RE energy to average CSI-RS RE energy	0dB
Ratio of hypothetical PDCCH DMRS energy to average CSI-RS RE energy	0dB
Bandwidth (PRBs)	48
Sub-carrier spacing (kHz)	SCS of the active DL BWP
DMRS precoder granularity	REG bundle size
REG bundle size	6
CP length	Normal
Mapping from REG to CCE	Distributed

### 12.3.1.3.2 Minimum requirement

IAB-MT shall be able to evaluate whether the downlink radio link quality on the configured RLM-RS resource estimated over the last  $T_{\text{Evaluate\_out\_CSI-RS}}$  [ms] period becomes worse than the threshold  $Q_{\text{out\_CSI-RS}}$  within  $T_{\text{Evaluate\_out\_CSI-RS}}$  [ms] evaluation period.

IAB-MT shall be able to evaluate whether the downlink radio link quality on the configured RLM-RS resource estimated over the last  $T_{\text{Evaluate\_in\_CSI-RS}}$  [ms] period becomes better than the threshold  $Q_{\text{in\_CSI-RS}}$  within  $T_{\text{Evaluate\_in\_CSI-RS}}$  [ms] evaluation period.

- $T_{\text{Evaluate\_out\_CSI-RS}}$  and  $T_{\text{Evaluate\_in\_CSI-RS}}$  are defined in Table 12.3.1.3.2-1 for FR1 with scaling factor  $K_1 = 5$ .
- $T_{\text{Evaluate\_out\_CSI-RS}}$  and  $T_{\text{Evaluate\_in\_CSI-RS}}$  are defined in Table 12.3.1.3.2-2 for FR2-1 with scaling factor  $K_2 = 3$ .

The requirements of  $T_{\text{Evaluate\_out\_CSI-RS}}$  and  $T_{\text{Evaluate\_in\_CSI-RS}}$  apply provided that the CSI-RS for RLM is not in a resource set configured with repetition ON. The requirements do not apply when the CSI-RS resource in the active TCI state of CORESET is the same CSI-RS resource for RLM and the TCI state information of the CSI-RS resource is not given, wherein the TCI state information means QCL Type-D to SSB for L1-RSRP or CSI-RS with repetition ON.

For FR1,

- $P=1$ .

For FR2-1,

- $P=1$ , when the RLM-RS resource is not overlapped with SMTC occasion.
- $P = \frac{1}{1 - \frac{T_{CSI-RS}}{T_{SMTCperiod}}}$ , when the RLM-RS resource is partially overlapped with SMTC occasion ( $T_{CSI-RS} < T_{SMTCperiod}$ ).
- $P = 3$ , when the RLM-RS resource is fully overlapped with SMTC occasion ( $T_{CSI-RS} = T_{SMTCperiod}$ ).

If the IAB-MT is not capable of 4 SMTC configurations per frequency [15], and is provided with higher layer signaling of  $smtc_j$ , where  $1 \leq j \leq 2$  [15], then  $T_{SMTCperiod}$  follows  $smtc_{j_{max}}$  where  $j_{max}$  is the maximum value of all  $j$  for which  $smtc_j$  has been configured.

If the IAB-MT is capable of 4 SMTC configurations per frequency [15], and is provided with higher layer signaling of  $smtc_j$ , where  $1 \leq j \leq 4$  [15], then  $T_{SMTCperiod}$  follows  $smtc_{j_{max}}$  where  $j_{max}$  is the maximum value of all  $j$  for which  $smtc_j$  has been configured.

NOTE: The overlap between CSI-RS for RLM and SMTC means that CSI-RS based RLM is within the SMTC window duration.

Longer evaluation period would be expected if the combination of RLM-RS resource and SMTC occasion configurations does not meet previous conditions.

The values of  $M_{out}$  and  $M_{in}$  used in Table 12.3.1.3.2-1 and Table 12.3.1.3.2-2 are defined as:

- $M_{out} = 20$  and  $M_{in} = 10$ , if the CSI-RS resource configured for RLM is transmitted with higher layer CSI-RS parameter *density* [8, clause 7.4.1] set to 3 and over the bandwidth  $\geq 24$  PRBs.

**Table 12.3.1.3.2-1: Evaluation period  $T_{Evaluate\_out\_CSI-RS}$  and  $T_{Evaluate\_in\_CSI-RS}$  for FR1**

Configuration	$T_{Evaluate\_out\_CSI-RS}$ (ms)	$T_{Evaluate\_in\_CSI-RS}$ (ms)
no DRX	$\text{Max}(200 \times K_1, \text{Ceil}(M_{out} \times P \times K_1) \times T_{CSI-RS})$	$\text{Max}(100 \times K_1, \text{Ceil}(M_{in} \times P \times K_1) \times T_{CSI-RS})$
NOTE: $T_{CSI-RS}$ is the periodicity of the CSI-RS resource configured for RLM. The requirements in this table apply for $T_{CSI-RS}$ equal to 5 ms, 10ms, 20 ms or 40 ms.		

**Table 12.3.1.3.2-2: Evaluation period  $T_{Evaluate\_out\_CSI-RS}$  and  $T_{Evaluate\_in\_CSI-RS}$  for FR2-1**

Configuration	$T_{Evaluate\_out\_CSI-RS}$ (ms)	$T_{Evaluate\_in\_CSI-RS}$ (ms)
no DRX	$\text{Max}(200 \times K_2, \text{Ceil}(M_{out} \times P \times K_2) \times T_{CSI-RS})$	$\text{Max}(100 \times K_2, \text{Ceil}(M_{in} \times P \times K_2) \times T_{CSI-RS})$
NOTE: $T_{CSI-RS}$ is the periodicity of the CSI-RS resource configured for RLM. The requirements in this table apply for $T_{CSI-RS}$ equal to 5 ms, 10 ms, 20 ms or 40 ms.		

### 12.3.1.3.3 Measurement restrictions for CSI-RS based RLM

The UE requirements in sub-clause 8.1.3.3 [6] apply for IAB-MT.

### 12.3.1.4 Minimum requirement for IAB-MT turning off the transmitter

The UE requirements in sub-clause 8.1.5 [6] apply for IAB-MT.

### 12.3.1.5 Minimum requirement for L1 indication

When the downlink radio link quality on all the configured RLM-RS resources is worse than  $Q_{out}$ , layer 1 of the IAB-MT shall send an out-of-sync indication for the cell to the higher layers. A layer 3 filter shall be applied to the out-of-sync indications as specified in TS 38.331 [15].

When the downlink radio link quality on at least one of the configured RLM-RS resources is better than  $Q_{in}$ , layer 1 of the IAB-MT shall send an in-sync indication for the cell to the higher layers. A layer 3 filter shall be applied to the in-sync indications as specified in TS 38.331 [15].

The out-of-sync and in-sync evaluations for the configured RLM-RS resources shall be performed as specified in clause 5 [10]. Two successive indications from layer 1 shall be separated by at least  $T_{\text{Indication\_interval}}$ .

$T_{\text{Indication\_interval}}$  is  $\max(10\text{ms}, T_{\text{RLM-RS,M}})$ , where  $T_{\text{RLM-RS,M}}$  is the shortest periodicity of all configured RLM-RS resources for the monitored cell, which corresponds to  $T_{\text{SSB}}$  specified in clause 12.3.1.2 if the RLM-RS resource is SSB, or  $T_{\text{CSI-RS}}$  specified in clause 12.3.1.3 if the RLM-RS resource is CSI-RS.

### 12.3.1.6 Scheduling availability of IAB-MT during radio link monitoring

The UE requirements in sub-clause 8.1.7 [6] apply for IAB-MT.

## 12.3.2 Link Recovery Procedure

### 12.3.2.1 Introduction

The UE requirements in sub-clause 8.5.1 [6] apply for IAB-MT.

### 12.3.2.2 Requirements for SSB based beam failure detection

#### 12.3.2.2.1 Introduction

The UE requirements in sub-clause 8.5.2.1 [6] apply for IAB-MT.

#### 12.3.2.2.2 Minimum requirement

IAB-MT shall be able to evaluate whether the downlink radio link quality on the configured SSB resource in set  $\bar{q}_0$  estimated over the last  $T_{\text{Evaluate\_BFD\_SSB}}$  ms period becomes worse than the threshold  $Q_{\text{out\_LR\_SSB}}$  within  $T_{\text{Evaluate\_BFD\_SSB}}$  ms period.

The value of  $T_{\text{Evaluate\_BFD\_SSB}}$  is defined in Table 12.3.2.2.2-1 for FR1.

The value of  $T_{\text{Evaluate\_BFD\_SSB}}$  is defined in Table 12.3.2.2.2-2 for FR2 with scaling factor  $N=8$ .

For FR1,

- $P=1$ .

For FR2,

- $P=1$ , when the BFD-RS resource is not overlapped with SMTC occasion.
- $P = \frac{1}{1 - \frac{T_{\text{SSB}}}{T_{\text{SMTCperiod}}}}$ , when the BFD-RS resource is partially overlapped with SMTC occasion ( $T_{\text{SSB}} < T_{\text{SMTCperiod}}$ ).
- $P = 3$ , when the BFD-RS resource is fully overlapped with SMTC period ( $T_{\text{SSB}} = T_{\text{SMTCperiod}}$ ).

If the IAB-MT is not capable of 4 SMTC configurations per frequency [15], and is provided with higher layer signaling of  $\text{smtcj}$ , where  $1 \leq j \leq 2$  [15], then  $T_{\text{SMTCperiod}}$  follows  $\text{smtcj}_{\text{max}}$  where  $j_{\text{max}}$  is the maximum value of all  $j$  for which  $\text{smtcj}$  has been configured.

If the IAB-MT is capable of 4 SMTC configurations per frequency [15], and is provided with higher layer signaling of  $\text{smtcj}$ , where  $1 \leq j \leq 4$  [15], then  $T_{\text{SMTCperiod}}$  follows  $\text{smtcj}_{\text{max}}$  where  $j_{\text{max}}$  is the maximum value of all  $j$  for which  $\text{smtcj}$  has been configured.

Longer evaluation period would be expected if the combination of BFD-RS resource and SMTC occasion does not meet pervious conditions.

**Table 12.3.2.2-1: Evaluation period  $T_{\text{Evaluate\_BFD\_SSB}}$  for FR1**

Configuration	$T_{\text{Evaluate\_BFD\_SSB}}$ (ms)
no DRX	$\text{Max}(50, \text{Ceil}(5 \times P) \times T_{\text{SSB}})$
Note:	$T_{\text{SSB}}$ is the periodicity of SSB in the set $\bar{q}_0$ .

**Table 12.3.2.2-2: Evaluation period  $T_{\text{Evaluate\_BFD\_SSB}}$  for FR2**

Configuration	$T_{\text{Evaluate\_BFD\_SSB}}$ (ms)
no DRX	$\text{Max}(50, \text{Ceil}(5 \times P \times N) \times T_{\text{SSB}})$
Note:	$T_{\text{SSB}}$ is the periodicity of SSB in the set $\bar{q}_0$ .

### 12.3.2.2.3 Measurement restriction for SSB based beam failure detection

The UE requirements in sub-clause 8.5.2.3 [6] apply for IAB-MT.

### 12.3.2.3 Requirements for CSI-RS based beam failure detection

#### 12.3.2.3.1 Introduction

The UE requirements in sub-clause 8.5.3.1 [6] apply for IAB-MT.

#### 12.3.2.3.2 Minimum requirement

IAB-MT shall be able to evaluate whether the downlink radio link quality on the CSI-RS resource in set  $\bar{q}_0$  estimated over the last  $T_{\text{Evaluate\_BFD\_CSI-RS}}$  ms period becomes worse than the threshold  $Q_{\text{out\_LR\_CSI-RS}}$  within  $T_{\text{Evaluate\_BFD\_CSI-RS}}$  ms period.

The value of  $T_{\text{Evaluate\_BFD\_CSI-RS}}$  is defined in Table 12.3.2.3.2-1 for FR1.

The value of  $T_{\text{Evaluate\_BFD\_CSI-RS}}$  is defined in Table 12.3.2.3.2-2 for FR2-1 with  $N=1$ .

The requirements of  $T_{\text{Evaluate\_BFD\_CSI-RS}}$  apply provided that the CSI-RS for BFD is not in a resource set configured with repetition ON. The requirements shall not apply when the CSI-RS resource in the active TCI state of CORESET is the same CSI-RS resource for BFD and the TCI state information of the CSI-RS resource is not given, wherein the TCI state information means QCL Type-D to SSB for L1-RSRP or CSI-RS with repetition ON.

For FR1,

- $P = 1$ .

For FR2-1,

- $P = 1$ , when the BFD-RS resource is not overlapped with SMTC occasion.
- $P = \frac{1}{1 + \frac{T_{\text{CSI-RS}}}{T_{\text{SMTCperiod}}}}$ , when the BFD-RS resource is partially overlapped with SMTC occasion ( $T_{\text{CSI-RS}} < T_{\text{SMTCperiod}}$ ).
- $P = P_{\text{sharing factor}}$ , when BFD-RS resource is fully overlapped with SMTC occasion ( $T_{\text{CSI-RS}} = T_{\text{SMTCperiod}}$ ).
- $P_{\text{sharing factor}} = 3$ .

If the IAB-MT is not capable of 4 SMTC configurations per frequency [15], and is provided with higher layer signaling of  $\text{smtc}_j$ , where  $1 \leq j \leq 2$  [15], then  $T_{\text{SMTCperiod}}$  follows  $\text{smtc}_{j_{\text{max}}}$  where  $j_{\text{max}}$  is the maximum value of all  $j$  for which  $\text{smtc}_j$  has been configured.

If the IAB-MT is capable of 4 SMTC configurations per frequency [15], and is provided with higher layer signaling of  $\text{smtc}_j$ , where  $1 \leq j \leq 4$  [15], then  $T_{\text{SMTCperiod}}$  follows  $\text{smtc}_{j_{\text{max}}}$  where  $j_{\text{max}}$  is the maximum value of all  $j$  for which  $\text{smtc}_j$  has been configured.

NOTE: The overlap between CSI-RS for BFD and SMTC means that CSI-RS for BFD is within the SMTC window duration.

Longer evaluation period would be expected if the combination of the BFD-RS resource and SMTC occasion configurations does not meet previous conditions.

The values of  $M_{\text{BFD}}$  used in Table 12.3.2.3.2-1 and Table 12.3.2.3.2-2 are defined as

- $M_{\text{BFD}} = 10$ , if the CSI-RS resource(s) in set  $\bar{q}_0$  used for BFD is transmitted with Density = 3 and over the bandwidth  $\geq 24$  PRBs.

**Table 12.3.2.3.2-1: Evaluation period  $T_{\text{Evaluate\_BFD\_CSI-RS}}$  for FR1**

Configuration	$T_{\text{Evaluate\_BFD\_CSI-RS}}$ (ms)
no DRX	$\text{Max}(50, [M_{\text{BFD}} \times P] \times T_{\text{CSI-RS}})$
Note:	$T_{\text{CSI-RS}}$ is the periodicity of CSI-RS resource in the set $\bar{q}_0$ .

**Table 12.3.2.3.2-2: Evaluation period  $T_{\text{Evaluate\_BFD\_CSI-RS}}$  for FR2-1**

Configuration	$T_{\text{Evaluate\_BFD\_CSI-RS}}$ (ms)
no DRX	$\text{Max}(50, [M_{\text{BFD}} \times P \times N] \times T_{\text{CSI-RS}})$
Note:	$T_{\text{CSI-RS}}$ is the periodicity of CSI-RS resource in the set $\bar{q}_0$ .

### 12.3.2.3.3 Measurement restrictions for CSI-RS based beam failure detection

The UE requirements in sub-clause 8.5.3.3 [6] apply for IAB-MT.

### 12.3.2.4 Minimum requirement for L1 indication

When the radio link quality on all the RS resources in set  $\bar{q}_0$  is worse than  $Q_{\text{out\_LR}}$ , layer 1 of the IAB-MT shall send a beam failure instance indication to the higher layers. A layer 3 filter may be applied to the beam failure instance indications as specified in TS 38.331 [15].

The beam failure instance evaluation for the RS resources in set  $\bar{q}_0$  shall be performed as specified in clause 6 in TS 38.213 [10]. Two successive indications from layer 1 shall be separated by at least  $T_{\text{Indication\_interval\_BFD}}$ .

$T_{\text{Indication\_interval\_BFD}}$  is  $\text{max}(2\text{ms}, T_{\text{SSB-RS,M}})$  or  $\text{max}(2\text{ms}, T_{\text{CSI-RS,M}})$ , where  $T_{\text{SSB-RS,M}}$  and  $T_{\text{CSI-RS,M}}$  is the shortest periodicity of all RS resources in set  $\bar{q}_0$  for the accessed cell, corresponding to either the shortest periodicity of the SSB in the set  $\bar{q}_0$  or CSI-RS resource in the set  $\bar{q}_0$ .

### 12.3.2.5 Requirements for SSB based candidate beam detection

#### 12.3.2.5.1 Introduction

The requirements in this clause apply for each SSB resource in the set  $\bar{q}_1$  configured for a serving cell, provided that the SSBs configured for candidate beam detection are actually transmitted within IAB-MT active DL BWP during the entire evaluation period specified in clause 12.3.2.5.2.

#### 12.3.2.5.2 Minimum requirement

Upon request the IAB-MT shall be able to evaluate whether the L1-RSRP measured on the configured SSB resource in set  $\bar{q}_1$  estimated over the last  $T_{\text{Evaluate\_CBD\_SSB}}$  ms period becomes better than the threshold  $Q_{\text{in\_LR}}$  provided SSB<sub>RP</sub> and SSB  $\hat{E}_s/I_{\text{ot}}$  are according to Annex Table in B.2.4.1 [6] for a corresponding band.



The IAB-MT shall monitor the configured SSB resources using the evaluation period in table 12.3.2.5.2-1 and 12.3.2.5.2-2 which is applicable to the non-DRX mode only.

The value of  $T_{\text{Evaluate\_CBD\_SSB}}$  is defined in Table 12.3.2.5.2-1 for FR1.

The value of  $T_{\text{Evaluate\_CBD\_SSB}}$  is defined in Table 12.3.2.5.2-2 for FR2-1 with scaling factor  $N=8$ .

Where,

For FR1,

- $P = 1$ .

For FR2-1,

- $P=1$ , when the candidate beam detection RS resource is not overlapped with SMTC occasion.
- $P = \frac{1}{1 - \frac{T_{\text{SSB}}}{T_{\text{SMTCperiod}}}}$ , when candidate beam detection RS is partially overlapped with SMTC occasion ( $T_{\text{SSB}} < T_{\text{SMTCperiod}}$ ).
- $P = 3$ , when candidate beam detection RS is fully overlapped with SMTC period ( $T_{\text{SSB}} = T_{\text{SMTCperiod}}$ ).

If the IAB-MT is not capable of 4 SMTC configurations per frequency [15], and is provided with higher layer signaling of  $\text{smtc}_j$ , where  $1 \leq j \leq 2$  [15], then  $T_{\text{SMTCperiod}}$  follows  $\text{smtc}_{j_{\text{max}}}$  where  $j_{\text{max}}$  is the maximum value of all  $j$  for which  $\text{smtc}_j$  has been configured.

If the IAB-MT is capable of 4 SMTC configurations per frequency [15], and is provided with higher layer signaling of  $\text{smtc}_j$ , where  $1 \leq j \leq 4$  [15], then  $T_{\text{SMTCperiod}}$  follows  $\text{smtc}_{j_{\text{max}}}$  where  $j_{\text{max}}$  is the maximum value of all  $j$  for which  $\text{smtc}_j$  has been configured.

Longer evaluation period would be expected if the combination of CBD-RS resource and SMTC occasion configurations does not meet previous conditions.

**Table 12.3.2.5.2-1: Evaluation period  $T_{\text{Evaluate\_CBD\_SSB}}$  for FR1**

Configuration	$T_{\text{Evaluate\_CBD\_SSB}}$ (ms)
non-DRX	$\text{Ceil}(3 \times P) \times T_{\text{SSB}}$
Note:	$T_{\text{SSB}}$ is the periodicity of SSB in the set $\bar{q}_1$ .

**Table 12.3.2.5.2-2: Evaluation period  $T_{\text{Evaluate\_CBD\_SSB}}$  for FR2-1**

Configuration	$T_{\text{Evaluate\_CBD\_SSB}}$ (ms)
non-DRX	$\text{Ceil}(3 \times P \times N) \times T_{\text{SSB}}$
Note:	$T_{\text{SSB}}$ is the periodicity of SSB in the set $\bar{q}_1$ .

### 12.3.2.5.3 Measurement restriction for SSB based candidate beam detection

The UE requirements in sub-clause 8.5.5.3 [6] apply for IAB-MT.

### 12.3.2.6 Requirements for CSI-RS based candidate beam detection

#### 12.3.2.6.1 Introduction

The requirements in this clause apply for each CSI-RS resource in the set  $\bar{q}_1$  configured for a serving cell, provided that the CSI-RS resources configured for candidate beam detection are actually transmitted within IAB MT active DL BWP during the entire evaluation period specified in clause 12.3.2.6.2.

### 12.3.2.6.2 Minimum requirement

Upon request the IAB-MT shall be able to evaluate whether the L1-RSRP measured on the configured CSI-RS resource in set  $\bar{q}_1$  estimated over the last  $T_{\text{Evaluate\_CBD\_CSI-RS}}$  [ms] period becomes better than the threshold  $Q_{\text{in\_LR}}$  within  $T_{\text{Evaluate\_CBD\_CSI-RS}}$  [ms] period provided CSI-RS  $\hat{E}_s/I_{ot}$  is according to Annex Table in B.2.4.2 [6] for a corresponding band.

The IAB-MT shall monitor the configured CSI-RS resources using the evaluation period in table 12.3.2.6.2-1 and 12.3.2.6.2-2 which is applicable to the non-DRX mode only.

The value of  $T_{\text{Evaluate\_CBD\_CSI-RS}}$  is defined in Table 12.3.2.6.2-1 for FR1.

The value of  $T_{\text{Evaluate\_CBD\_CSI-RS}}$  is defined in Table 12.3.2.6.2-2 for FR2 with scaling factor  $N=8$ .

For FR1,

- $P = 1$ .

For FR2-1,

- $P = 1$ , when candidate beam detection RS is not overlapped with SMTC occasion.
- $P = \frac{1}{1 - \frac{T_{\text{CSI-RS}}}{T_{\text{SMTCperiod}}}}$ , when candidate beam detection RS is partially overlapped with SMTC occasion ( $T_{\text{CSI-RS}} < T_{\text{SMTCperiod}}$ ).
- $P = 3$ , when candidate beam detection RS is fully overlapped with SMTC occasion ( $T_{\text{CSI-RS}} = T_{\text{SMTCperiod}}$ ).

If the IAB-MT is not capable of 4 SMTC configurations per frequency [15], and is provided with higher layer signaling of  $\text{smtc}_j$ , where  $1 \leq j \leq 2$  [15], then  $T_{\text{SMTCperiod}}$  follows  $\text{smtc}_{j_{\text{max}}}$  where  $j_{\text{max}}$  is the maximum value of all  $j$  for which  $\text{smtc}_j$  has been configured.

If the IAB-MT is capable of 4 SMTC configurations per frequency [15], and is provided with higher layer signaling of  $\text{smtc}_j$ , where  $1 \leq j \leq 4$  [15], then  $T_{\text{SMTCperiod}}$  follows  $\text{smtc}_{j_{\text{max}}}$  where  $j_{\text{max}}$  is the maximum value of all  $j$  for which  $\text{smtc}_j$  has been configured.

Longer evaluation period would be expected if the CSI-RS is on the same OFDM symbols with RLM, BFD, BM-RS, or other CBD-RS, according to the measurement restrictions defined in clause 12.3.2.6.3.

The values of  $M_{\text{CBD}}$  used in Table 12.3.2.6.2-1 and Table 12.3.2.6.2-2 are defined as

- $M_{\text{CBD}} = 3$ , if the CSI-RS resource configured in the set  $\bar{q}_1$  is transmitted with Density = 3 and over the bandwidth  $\geq 24$  PRBs.

**Table 12.3.2.6.2-1: Evaluation period  $T_{\text{Evaluate\_CBD\_CSI-RS}}$  for FR1**

Configuration	$T_{\text{Evaluate\_CBD\_CSI-RS}}$ (ms)
non-DRX	$\text{Max}(25, \text{Ceil}(M_{\text{CBD}} \times P) \times T_{\text{CSI-RS}})$
Note:	$T_{\text{CSI-RS}}$ is the periodicity of CSI-RS resource in the set $\bar{q}_1$ .

**Table 12.3.2.6.2-2: Evaluation period  $T_{\text{Evaluate\_CBD\_CSI-RS}}$  for FR2-1**

Configuration	$T_{\text{Evaluate\_CBD\_CSI-RS}}$ (ms)
non-DRX	$\text{Max}(25, \text{Ceil}(M_{\text{CBD}} \times P \times N) \times T_{\text{CSI-RS}})$
Note:	$T_{\text{CSI-RS}}$ is the periodicity of CSI-RS resource in the set $\bar{q}_1$ .

### 12.3.2.6.3 Measurement restriction for CSI-RS based candidate beam detection

The UE requirements in sub-clause 8.5.6.3 [6] apply for IAB-MT.

### 12.3.2.7 Scheduling availability of IAB-MT during beam failure detection

The UE requirements in sub-clause 8.5.7 [6] apply for IAB-MT.

### 12.3.2.8 Scheduling availability of IAB-MT during candidate beam detection

The UE requirements in sub-clause 8.5.8 [6] apply for IAB-MT.

## Annex A (normative): IAB-MT Reference measurement channels

### A.1 Fixed Reference Channels for reference sensitivity level, ACS, in-band blocking, out-of-band blocking and receiver intermodulation (QPSK, R=1/3)

The parameters for the reference measurement channels are specified in tables A.1-1 for FR1 reference sensitivity level, ACS, in-band blocking, out-of-band blocking, receiver intermodulation, OTA sensitivity, OTA reference sensitivity level, OTA ACS, OTA in-band blocking, OTA out-of-band blocking, and OTA receiver intermodulation.

The parameters for the reference measurement channels are specified in tables A.1-2 for FR2-1 OTA reference sensitivity level, OTA ACS, OTA in-band blocking, and OTA out-of-band blocking.

**Table A1-1: FRC parameters for FR1 reference sensitivity level for IAB-MT.**

Reference channel	G-FR1-A1-22	G-FR1-A1-23	G-FR1-A1-25	G-FR1-A1-26
Subcarrier spacing (kHz)	30	60	30	60
Allocated resource blocks	11	11	51	24
CP-OFDM Symbols per slot (Note 1)	9	9	9	9
Modulation	QPSK	QPSK	QPSK	QPSK
Code rate (Note 2)	1/3	1/3	1/3	1/3
NOTE 1: $DL-DMRS-config-type = 1$ with $DL-DMRS-max-len = 1$ , $DL-DMRS-add-pos = pos2$ with $l_0 = 2$ , $l_1 = 6$ and $9$ as per Table 7.4.1.1.2-3 of TS 38.211 [3].				
NOTE 2: MCS index 4 and target coding rate = 308/1024 are adopted to calculate payload size for receiver sensitivity				

**Table A1-2: FRC parameters for FR2-1 reference sensitivity level for IAB-MT.**

Reference channel	G-FR2-A1-21	G-FR2-A1-22	G-FR2-A1-23
Subcarrier spacing (kHz)	60	120	120
Allocated resource blocks	66	32	66
CP-OFDM Symbols per slot (Note 1)	9	9	9
Modulation	QPSK	QPSK	QPSK
Code rate (Note 2)	1/3	1/3	1/3
NOTE 1: DM-RS configuration type = 1 with DM-RS duration = single-symbol DM-RS, additional DM-RS position = $pos2$ with $l_0 = 2$ , $l_1 = 6$ and $9$ as per Table 7.4.1.1.2-3 of TS 38.211 [3].			
NOTE 2: MCS index 4 and target coding rate = 308/1024 are adopted to calculate payload size.			

### A.2 IAB-DU Fixed Reference Channels

#### A.2.1 Fixed Reference Channels for PUSCH performance requirements (QPSK, R=193/1024)

The parameters for the reference measurement channels are specified in table A.2.1-1 to table A.2.1-3 for FR1 PUSCH performance requirements:

- FRC parameters are specified in table A.2.1-1 for FR1 PUSCH with transform precoding disabled, Additional DM-RS position =  $pos1$  and 1 transmission layer.
- FRC parameters are specified in table A.2.1-2 for FR1 PUSCH with transform precoding disabled, Additional DM-RS position =  $pos1$  and 2 transmission layers.
- FRC parameters are specified in table A.2.1-3 for FR1 PUSCH with transform precoding enabled, Additional DM-RS position =  $pos1$  and 1 transmission layer.

The parameters for the reference measurement channels are specified in table A.2.1-4 to table A.2.1-9 for FR2-1 PUSCH performance requirements:

- FRC parameters are specified in table A.2.1-4 for FR2-1 PUSCH with transform precoding disabled, Additional DM-RS position = pos0 and 1 transmission layer.
- FRC parameters are specified in table A.2.1-5 for FR2-1 PUSCH with transform precoding disabled, Additional DM-RS position = pos0 and 2 transmission layers.
- FRC parameters are specified in table A.2.1-6 for FR2-1 PUSCH with transform precoding enabled, Additional DM-RS position = pos0 and 1 transmission layer.
- FRC parameters are specified in table A.2.1-7 for FR2-1 PUSCH with transform precoding disabled, Additional DM-RS position = pos1 and 1 transmission layer.
- FRC parameters are specified in table A.2.1-8 for FR2-1 PUSCH with transform precoding disabled, Additional DM-RS position = pos1 and 2 transmission layers.
- FRC parameters are specified in table A.2.1-9 for FR2-1 PUSCH with transform precoding enabled, Additional DM-RS position = pos1 and 1 transmission layer.

**Table A.2.1-1: FRC parameters for FR1 PUSCH performance requirements, transform precoding disabled, Additional DM-RS position = pos1 and 1 transmission layer (QPSK, R=193/1024)**

Reference channel	D-FR1-A.2.1-1	D-FR1-A.2.1-2	D-FR1-A.2.1-3	D-FR1-A.2.1-4	D-FR1-A.2.1-5	D-FR1-A.2.1-6	D-FR1-A.2.1-7
Subcarrier spacing [kHz]	15	15	15	30	30	30	30
Allocated resource blocks	25	52	106	24	51	106	273
CP-OFDM Symbols per slot (Note 1)	12	12	12	12	12	12	12
Modulation	QPSK	QPSK	QPSK	QPSK	QPSK	QPSK	QPSK
Code rate	193/1024	193/1024	193/1024	193/1024	193/1024	193/1024	193/1024
Payload size (bits)	1352	2856	5768	1320	2792	5768	14856
Transport block CRC (bits)	16	16	24	16	16	24	24
Code block CRC size (bits)	-	-	24	-	-	24	24
Number of code blocks - C	1	1	2	1	1	2	4
Code block size including CRC (bits) (Note 2)	1368	2872	2920	1336	2808	2920	3744
Total number of bits per slot	7200	14976	30528	6912	14688	30528	78624
Total symbols per slot	3600	7488	15264	3456	7344	15264	39312
NOTE 1: <i>DM-RS configuration type</i> = 1 with <i>DM-RS duration</i> = single-symbol <i>DM-RS</i> and the number of DM-RS CDM groups without data is 2, <i>Additional DM-RS position</i> = pos1, $l_0=2$ and $l=11$ for PUSCH mapping type A, $l_0=0$ and $l=10$ for PUSCH mapping type B as per table 6.4.1.1.3-3 of TS 38.211 [8].							
NOTE 2: Code block size including CRC (bits) equals to $K'$ in clause 5.2.2 of TS 38.212 [9].							

**Table A.2.1-2: FRC parameters for FR1 PUSCH performance requirements, transform precoding disabled, Additional DM-RS position = pos1 and 2 transmission layers (QPSK, R=193/1024)**

Reference channel	D-FR1-A.2.1-8	D-FR1-A.2.1-9	D-FR1-A.2.1-10	D-FR1-A.2.1-11	D-FR1-A.2.1-12	D-FR1-A.2.1-13	D-FR1-A.2.1-14
Subcarrier spacing [kHz]	15	15	15	30	30	30	30
Allocated resource blocks	25	52	106	24	51	106	273
CP-OFDM Symbols per slot (Note 1)	12	12	12	12	12	12	12
Modulation	QPSK	QPSK	QPSK	QPSK	QPSK	QPSK	QPSK
Code Rate	193/1024	193/1024	193/1024	193/1024	193/1024	193/1024	193/1024
Payload size (bits)	2728	5640	11528	2600	5512	11528	29736
Transport block CRC (bits)	16	24	24	16	24	24	24
Code block CRC size (bits)	-	24	24	-	24	24	24
Number of code blocks - C	1	2	4	1	2	4	8
Code block size including CRC (bits) (Note 2)	2744	2856	2912	2616	2792	2912	3744
Total number of bits per slot	14400	29952	61056	13824	29376	61056	157248
Total symbols per slot	7200	14976	30528	6912	14688	30528	78624

NOTE 1: *DM-RS configuration type* = 1 with *DM-RS duration* = *single-symbol DM-RS* and the number of DM-RS CDM groups without data is 2, *Additional DM-RS position* = *pos1*,  $l_0=2$  and  $l=11$  for PUSCH mapping type A,  $l_0=0$  and  $l=10$  for PUSCH mapping type B as per table 6.4.1.1.3-3 of TS 38.211 [8].

NOTE 2: Code block size including CRC (bits) equals to  $K'$  in clause 5.2.2 of TS 38.212 [9].

**Table A.2.1-3: FRC parameters for FR1 PUSCH performance requirements, transform precoding enabled, Additional DM-RS position = pos1 and 1 transmission layer (QPSK, R=193/1024)**

Reference channel	D-FR1-A.2.1-15	D-FR1-A.2.1-16
Subcarrier spacing [kHz]	15	30
Allocated resource blocks	25	24
DFT-s-OFDM Symbols per slot (Note 1)	12	12
Modulation	QPSK	QPSK
Code Rate	193/1024	193/1024
Payload size (bits)	1352	1320
Transport block CRC (bits)	16	16
Code block CRC size (bits)	-	-
Number of code blocks - C	1	1
Code block size including CRC (bits) (Note 2)	1368	1336
Total number of bits per slot	7200	6912
Total symbols per slot	3600	3456

NOTE 1: *DM-RS configuration type* = 1 with *DM-RS duration* = *single-symbol DM-RS* and the number of DM-RS CDM groups without data is 2, *Additional DM-RS position* = *pos1*,  $l_0=2$  and  $l=11$  for PUSCH mapping type A,  $l_0=0$  and  $l=10$  for PUSCH mapping type B as per Table 6.4.1.1.3-3 of TS 38.211 [8].

NOTE 2: Code block size including CRC (bits) equals to  $K'$  in sub-clause 5.2.2 of TS 38.212 [9].

**Table A.2.1-4: FRC parameters for FR2-1 PUSCH performance requirements, transform precoding disabled, Additional DM-RS position = pos0 and 1 transmission layer (QPSK, R=193/1024)**

Reference channel	D-FR2-A.2.1-1	D-FR2-A.2.1-2	D-FR2-A.2.1-3	D-FR2-A.2.1-4	D-FR2-A.2.1-5
Subcarrier spacing [kHz]	60	60	120	120	120
Allocated resource blocks	66	132	32	66	132
CP-OFDM Symbols per slot (Note 1)	9	9	9	9	9
Modulation	QPSK	QPSK	QPSK	QPSK	QPSK
Code Rate	193/1024	193/1024	193/1024	193/1024	193/1024
Payload size (bits)	2664	5384	1320	2664	5384
Transport block CRC (bits)	16	24	16	16	24
Code block CRC size (bits)	-	24	-	-	24
Number of code blocks - C	1	2	1	1	2
Code block size including CRC (bits) (Note 2)	2680	2728	1336	2680	2728
Total number of bits per slot	14256	28512	6912	14256	28512
Total symbols per slot	7128	14256	3456	7128	14256
NOTE 1: DM-RS configuration type = 1 with DM-RS duration = single-symbol DM-RS and the number of DM-RS CDM groups without data is 2, Additional DM-RS position = pos0 with $l_0 = 0$ as per Table 6.4.1.1.3-3 of TS 38.211 [8].					
NOTE 2: Code block size including CRC (bits) equals to $K'$ in sub-clause 5.2.2 of TS 38.212 [9].					

**Table A.2.1-5: FRC parameters for FR2-1 PUSCH performance requirements, transform precoding disabled, Additional DM-RS position = pos0 and 2 transmission layers (QPSK, R=193/1024)**

Reference channel	D-FR2-A.2.1-6	D-FR2-A.2.1-7	D-FR2-A.2.1-8	D-FR2-A.2.1-9	D-FR2-A.2.1-10
Subcarrier spacing [kHz]	60	60	120	120	120
Allocated resource blocks	66	132	32	66	132
CP-OFDM Symbols per slot (Note 1)	9	9	9	9	9
Modulation	QPSK	QPSK	QPSK	QPSK	QPSK
Code Rate	193/1024	193/1024	193/1024	193/1024	193/1024
Payload size (bits)	5384	10752	2600	5384	10752
Transport block CRC (bits)	24	24	16	24	24
Code block CRC size (bits)	24	24	-	24	24
Number of code blocks - C	2	3	1	2	3
Code block size including CRC (bits) (Note 2)	2728	3616	2616	2728	3616
Total number of bits per slot	28512	57024	13824	28512	57024
Total symbols per slot	14256	28512	6912	14256	28512
NOTE 1: DM-RS configuration type = 1 with DM-RS duration = single-symbol DM-RS and the number of DM-RS CDM groups without data is 2, Additional DM-RS position = pos0 with $l_0 = 0$ as per Table 6.4.1.1.3-3 of TS 38.211 [8].					
NOTE 2: Code block size including CRC (bits) equals to $K'$ in sub-clause 5.2.2 of TS 38.212 [9].					

**Table A.2.1-6: FRC parameters for FR2-1 PUSCH performance requirements, transform precoding enabled, Additional DM-RS position = pos0 and 1 transmission layer (QPSK, R=193/1024)**

Reference channel	D-FR2-A.2.1-11	D-FR2-A.2.1-12
Subcarrier spacing [kHz]	60	120
Allocated resource blocks	30	30
DFT-s-OFDM Symbols per slot (Note 1)	9	9
Modulation	QPSK	QPSK
Code Rate	193/1024	193/1024
Payload size (bits)	1224	1224
Transport block CRC (bits)	16	16
Code block CRC size (bits)	-	-
Number of code blocks - C	1	1
Code block size including CRC (bits) (Note 2)	1240	1240
Total number of bits per slot	6480	6480
Total symbols per slot	3240	3240
NOTE 1: DM-RS configuration type = 1 with DM-RS duration = single-symbol DM-RS and the number of DM-RS CDM groups without data is 2, Additional DM-RS position = pos0 with $l_0 = 0$ as per Table 6.4.1.1.3-3 of TS 38.211 [8].		
NOTE 2: Code block size including CRC (bits) equals to $K'$ in sub-clause 5.2.2 of TS 38.212 [9].		

**Table A.2.1-7: FRC parameters for FR2-1 PUSCH performance requirements, transform precoding disabled, Additional DM-RS position = pos1 and 1 transmission layer (QPSK, R=193/1024)**

Reference channel	D-FR2-A.2.1-13	D-FR2-A.2.1-14	D-FR2-A.2.1-15	D-FR2-A.2.1-16	D-FR2-A.2.1-17
Subcarrier spacing [kHz]	60	60	120	120	120
Allocated resource blocks	66	132	32	66	132
CP-OFDM Symbols per slot (Note 1)	8	8	8	8	8
Modulation	QPSK	QPSK	QPSK	QPSK	QPSK
Code Rate	193/1024	193/1024	193/1024	193/1024	193/1024
Payload size (bits)	2408	4744	1160	2408	4744
Transport block CRC (bits)	16	24	16	16	24
Code block CRC size (bits)	-	24	-	-	24
Number of code blocks - C	1	2	1	1	2
Code block size including CRC (bits) (Note 2)	2424	2408	1176	2424	2408
Total number of bits per slot	12672	25344	6144	12672	25344
Total symbols per slot	6336	12672	3072	6336	12672
NOTE 1: DM-RS configuration type = 1 with DM-RS duration = single-symbol DM-RS and the number of DM-RS CDM groups without data is 2, Additional DM-RS position = pos1 with $l_0 = 0$ and $l = 8$ as per Table 6.4.1.1.3-3 of TS 38.211 [8].					
NOTE 2: Code block size including CRC (bits) equals to $K'$ in sub-clause 5.2.2 of TS 38.212 [9].					



**Table A.2.1-8: FRC parameters for FR2-1 PUSCH performance requirements, transform precoding disabled, Additional DM-RS position = pos1 and 2 transmission layers (QPSK, R=193/1024)**

Reference channel	D-FR2-A.2.1-18	D-FR2-A.2.1-19	D-FR2-A.2.1-20	D-FR2-A.2.1-21	D-FR2-A.2.1-22
Subcarrier spacing [kHz]	60	60	120	120	120
Allocated resource blocks	66	132	32	66	132
CP-OFDM Symbols per slot (Note 1)	8	8	8	8	8
Modulation	QPSK	QPSK	QPSK	QPSK	QPSK
Code Rate	193/1024	193/1024	193/1024	193/1024	193/1024
Payload size (bits)	4744	9480	2408	4744	9480
Transport block CRC (bits)	24	24	16	24	24
Code block CRC size (bits)	24	24	-	24	24
Number of code blocks - C	2	3	1	2	3
Code block size including CRC (bits) (Note 2)	2408	3192	2424	2408	3192
Total number of bits per slot	25344	50688	12288	25344	50688
Total symbols per slot	12672	25344	6144	12672	25344
NOTE 1: DM-RS configuration type = 1 with DM-RS duration = single-symbol DM-RS and the number of DM-RS CDM groups without data is 2, Additional DM-RS position = pos1 with $l_0=0$ and $l=8$ as per Table 6.4.1.1.3-3 of TS 38.211 [8].					
NOTE 2: Code block size including CRC (bits) equals to $K'$ in sub-clause 5.2.2 of TS 38.212 [9].					

**Table A.2.1-9: FRC parameters for FR2-1 PUSCH performance requirements, transform precoding enabled, Additional DM-RS position = pos1 and 1 transmission layer (QPSK, R=193/1024)**

Reference channel	D-FR2-A.2.1-23	D-FR2-A.2.1-24
Subcarrier spacing [kHz]	60	120
Allocated resource blocks	30	30
DFT-s-OFDM Symbols per slot (Note 1)	8	8
Modulation	QPSK	QPSK
Code Rate	193/1024	193/1024
Payload size (bits)	1128	1128
Transport block CRC (bits)	16	16
Code block CRC size (bits)	-	-
Number of code blocks - C	1	1
Code block size including CRC (bits) (Note 2)	1144	1144
Total number of bits per slot	5760	5760
Total symbols per slot	2880	2880
NOTE 1: DM-RS configuration type = 1 with DM-RS duration = single-symbol DM-RS and the number of DM-RS CDM groups without data is 2, Additional DM-RS position = pos1 with $l_0=0$ and $l=8$ as per Table 6.4.1.1.3-3 of TS 38.211 [8].		
NOTE 2: Code block size including CRC (bits) equals to $K'$ in sub-clause 5.2.2 of TS 38.212 [9].		

## A.2.2 Fixed Reference Channels for PUSCH performance requirements (16QAM, R=434/1024)

The parameters for the reference measurement channels are specified in table A.2.2-1 for FR2-1 PUSCH performance requirements with transform precoding disabled, additional DM-RS position = pos0 and 2 transmission layers.

The parameters for the reference measurement channels are specified in table A.2.2-2 for FR2-1 PUSCH performance requirements with transform precoding disabled, additional DM-RS position = pos1 and 2 transmission layers.

**Table A.2.2-1: FRC parameters for FR2-1 PUSCH performance requirements, transform precoding disabled, Additional DM-RS position = pos0 and 2 transmission layers (16QAM, R=434/1024)**

Reference channel	D-FR2-A.2.2-1	D-FR2-A.2.2-2	D-FR2-A.2.2-3	D-FR2-A.2.2-4	D-FR2-A.2.2-5
Subcarrier spacing [kHz]	60	60	120	120	120
Allocated resource blocks	66	132	32	66	132
CP-OFDM Symbols per slot (Note 1)	9	9	9	9	9
Modulation	16QAM	16QAM	16QAM	16QAM	16QAM
Code Rate	434/1024	434/1024	434/1024	434/1024	434/1024
Payload size (bits)	24072	48168	11784	24072	48168
Transport block CRC (bits)	24	24	24	24	24
Code block CRC size (bits)	24	24	24	24	24
Number of code blocks - C	3	6	2	3	6
Code block size including CRC (bits) (Note 2)	8056	8056	5928	8056	8056
Total number of bits per slot	57024	114048	27648	57024	114048
Total symbols per slot	14256	28512	6912	14256	28512
NOTE 1: <i>DM-RS configuration type</i> = 1 with <i>DM-RS duration</i> = <i>single-symbol DM-RS</i> and the number of DM-RS CDM groups without data is 2, <i>Additional DM-RS position</i> = <i>pos0</i> with $l_0 = 0$ as per Table 6.4.1.1.3-3 of TS 38.211 [8].					
NOTE 2: Code block size including CRC (bits) equals to $K'$ in sub-clause 5.2.2 of TS 38.212 [9].					

**Table A.2.2-2: FRC parameters for FR2-1 PUSCH performance requirements, transform precoding disabled, Additional DM-RS position = pos1 and 2 transmission layers (16QAM, R=434/1024)**

Reference channel	D-FR2-A.2.2-6	D-FR2-A.2.2-7	D-FR2-A.2.2-8	D-FR2-A.2.2-9	D-FR2-A.2.2-10
Subcarrier spacing [kHz]	60	60	120	120	120
Allocated resource blocks	66	132	32	66	132
CP-OFDM Symbols per slot (Note 1)	8	8	8	8	8
Modulation	16QAM	16QAM	16QAM	16QAM	16QAM
Code Rate	434/1024	434/1024	434/1024	434/1024	434/1024
Payload size (bits)	21504	43032	10504	21504	43032
Transport block CRC (bits)	24	24	24	24	24
Code block CRC size (bits)	24	24	24	24	24
Number of code blocks - C	3	6	2	3	6
Code block size including CRC (bits) (Note 2)	7200	7200	5288	7200	7200
Total number of bits per slot	50688	101376	24576	50688	101376
Total symbols per slot	12672	25344	6144	12672	25344
NOTE 1: <i>DM-RS configuration type</i> = 1 with <i>DM-RS duration</i> = <i>single-symbol DM-RS</i> and the number of DM-RS CDM groups without data is 2, <i>Additional DM-RS position</i> = <i>pos1</i> with $l_0 = 0$ and $l = 8$ as per Table 6.4.1.1.3-3 of TS 38.211 [8].					
NOTE 2: Code block size including CRC (bits) equals to $K'$ in sub-clause 5.2.2 of TS 38.212 [9].					

### A.2.3 Fixed Reference Channels for PUSCH performance requirements (16QAM, R=658/1024)

The parameters for the reference measurement channels are specified in table A.2.3-1 and table A.2.3-2 for FR1 PUSCH performance requirements:

- FRC parameters are specified in table A.2.3-1 for FR1 PUSCH with transform precoding disabled, *Additional DM-RS position* = *pos1* and 1 transmission layer.
- FRC parameters are specified in table A.2.3-2 for FR1 PUSCH with transform precoding disabled, *Additional DM-RS position* = *pos1* and 2 transmission layers.

The parameters for the reference measurement channels are specified in table A.2.3-3 to table A.2.3-6 for FR2-1 PUSCH performance requirements:

- FRC parameters are specified in table A.2.3-3 for FR2-1 PUSCH with transform precoding disabled, *Additional DM-RS position* = *pos0* and 1 transmission layer.

- FRC parameters are specified in table A.2.3-4 for FR2-1 PUSCH with transform precoding disabled, *Additional DM-RS position = pos0* and 2 transmission layers.
- FRC parameters are specified in table A.2.3-5 for FR2-1 PUSCH with transform precoding disabled, *Additional DM-RS position = pos1* and 1 transmission layer.
- FRC parameters are specified in table A.2.3-6 for FR2-1 PUSCH with transform precoding disabled, *Additional DM-RS position = pos1* and 2 transmission layers.

**Table A.2.3-1: FRC parameters for FR1 PUSCH performance requirements, transform precoding disabled, *Additional DM-RS position = pos1* and 1 transmission layer (16QAM, R=658/1024)**

Reference channel	D-FR1-A.2.3-1	D-FR1-A.2.3-2	D-FR1-A.2.3-3	D-FR1-A.2.3-4	D-FR1-A.2.3-5	D-FR1-A.2.3-6	D-FR1-A.2.3-7
Subcarrier spacing [kHz]	15	15	15	30	30	30	30
Allocated resource blocks	25	52	106	24	51	106	273
CP-OFDM Symbols per slot (Note 1)	12	12	12	12	12	12	12
Modulation	16QAM	16QAM	16QAM	16QAM	16QAM	16QAM	16QAM
Code Rate	658/1024	658/1024	658/1024	658/1024	658/1024	658/1024	658/1024
Payload size (bits)	9224	19464	38936	8968	18960	38936	100392
Transport block CRC (bits)	24	24	24	24	24	24	24
Code block CRC size (bits)	24	24	24	24	24	24	24
Number of code blocks - C	2	3	5	2	3	5	12
Code block size including CRC (bits) (Note 2)	4648	6520	7816	4520	6352	7816	8392
Total number of bits per slot	14400	29952	61056	13824	29376	61056	157248
Total symbols per slot	3600	7488	15264	3456	7344	15264	39312
NOTE 1: <i>DM-RS configuration type = 1</i> with <i>DM-RS duration = single-symbol DM-RS</i> and the number of DM-RS CDM groups without data is 2, <i>Additional DM-RS position = pos1</i> , $l_0 = 2$ and $l = 11$ for PUSCH mapping type A, $l_0 = 0$ and $l = 10$ for PUSCH mapping type B as per table 6.4.1.1.3-3 of TS 38.211 [8].							
NOTE 2: Code block size including CRC (bits) equals to $K'$ in clause 5.2.2 of TS 38.212 [9].							

**Table A.2.3-2: FRC parameters for FR1 PUSCH performance requirements, transform precoding disabled, *Additional DM-RS position = pos1* and 2 transmission layers (16QAM, R=658/1024)**

Reference channel	D-FR1-A.2.3-8	D-FR1-A.2.3-9	D-FR1-A.2.3-10	D-FR1-A.2.3-11	D-FR1-A.2.3-12	D-FR1-A.2.3-13	D-FR1-A.2.3-14
Subcarrier spacing [kHz]	15	15	15	30	30	30	30
Allocated resource blocks	25	52	106	24	51	106	273
CP-OFDM Symbols per slot (Note 1)	12	12	12	12	12	12	12
Modulation	16QAM	16QAM	16QAM	16QAM	16QAM	16QAM	16QAM
Code Rate	658/1024	658/1024	658/1024	658/1024	658/1024	658/1024	658/1024
Payload size (bits)	18432	38936	77896	17928	37896	77896	200808
Transport block CRC (bits)	24	24	24	24	24	24	24
Code block CRC size (bits)	24	24	24	24	24	24	24
Number of code blocks - C	3	5	10	3	5	10	24
Code block size including CRC (bits) (Note 2)	6176	7816	7816	6008	7608	7816	8392
Total number of bits per slot	28800	59904	122112	27648	58752	122112	314496
Total symbols per slot	7200	14976	30528	6912	14688	30528	78624
NOTE 1: <i>DM-RS configuration type = 1</i> with <i>DM-RS duration = single-symbol DM-RS</i> and the number of DM-RS CDM groups without data is 2, <i>Additional DM-RS position = pos1</i> , $l_0 = 2$ and $l = 11$ for PUSCH mapping type A, $l_0 = 0$ and $l = 10$ for PUSCH mapping type B as per table 6.4.1.1.3-3 of TS 38.211 [8].							
NOTE 2: Code block size including CRC (bits) equals to $K'$ in clause 5.2.2 of TS 38.212 [9].							

**Table A.2.3-3: FRC parameters for FR2-1 PUSCH performance requirements, transform precoding disabled, Additional DM-RS position = pos0 and 1 transmission layer (16QAM, R=658/1024)**

Reference channel	D-FR2-A.2.3-1	D-FR2-A.2.3-2	D-FR2-A.2.3-3	D-FR2-A.2.3-4	D-FR2-A.2.3-5
Subcarrier spacing [kHz]	60	60	120	120	120
Allocated resource blocks	66	132	32	66	132
CP-OFDM Symbols per slot (Note 1)	9	9	9	9	9
Modulation	16QAM	16QAM	16QAM	16QAM	16QAM
Code Rate	658/1024	658/1024	658/1024	658/1024	658/1024
Payload size (bits)	18432	36896	8968	18432	36896
Transport block CRC (bits)	24	24	24	24	24
Code block CRC size (bits)	24	24	24	24	24
Number of code blocks - C	3	5	2	3	5
Code block size including CRC (bits) (Note 2)	6176	7408	4520	6176	7408
Total number of bits per slot	28512	57024	13824	28512	57024
Total symbols per slot	7128	14256	3456	7128	14256
NOTE 1: DM-RS configuration type = 1 with DM-RS duration = single-symbol DM-RS and the number of DM-RS CDM groups without data is 2, Additional DM-RS position = pos0 with $l_0 = 0$ as per Table 6.4.1.1.3-3 of TS 38.211 [8].					
NOTE 2: Code block size including CRC (bits) equals to $K'$ in sub-clause 5.2.2 of TS 38.212 [9].					

**Table A.2.3-4: FRC parameters for FR2-1 PUSCH performance requirements, transform precoding disabled, Additional DM-RS position = pos0 and 2 transmission layers (16QAM, R=658/1024)**

Reference channel	D-FR2-A.2.3-6	D-FR2-A.2.3-7	D-FR2-A.2.3-8	D-FR2-A.2.3-9	D-FR2-A.2.3-10
Subcarrier spacing [kHz]	60	60	120	120	120
Allocated resource blocks	66	132	32	66	132
CP-OFDM Symbols per slot (Note 1)	9	9	9	9	9
Modulation	16QAM	16QAM	16QAM	16QAM	16QAM
Code Rate	658/1024	658/1024	658/1024	658/1024	658/1024
Payload size (bits)	36896	73776	17928	36896	73776
Transport block CRC (bits)	24	24	24	24	24
Code block CRC size (bits)	24	24	24	24	24
Number of code blocks - C	5	9	3	5	9
Code block size including CRC (bits) (Note 2)	7408	8224	6008	7408	8224
Total number of bits per slot	57024	114048	27648	57024	114048
Total symbols per slot	14256	28512	6912	14256	28512
NOTE 1: DM-RS configuration type = 1 with DM-RS duration = single-symbol DM-RS and the number of DM-RS CDM groups without data is 2, Additional DM-RS position = pos0 with $l_0 = 0$ as per Table 6.4.1.1.3-3 of TS 38.211 [8].					
NOTE 2: Code block size including CRC (bits) equals to $K'$ in sub-clause 5.2.2 of TS 38.212 [9].					

**Table A.2.3-5: FRC parameters for FR2-1 PUSCH performance requirements, transform precoding disabled, *Additional DM-RS position = pos1* and 1 transmission layer (16QAM, R=658/1024)**

Reference channel	D-FR2-A.2.3-11	D-FR2-A.2.3-12	D-FR2-A.2.3-13	D-FR2-A.2.3-14	D-FR2-A.2.3-15
Subcarrier spacing [kHz]	60	60	120	120	120
Allocated resource blocks	66	132	32	66	132
CP-OFDM Symbols per slot (Note 1)	8	8	8	8	8
Modulation	16QAM	16QAM	16QAM	16QAM	16QAM
Code Rate	658/1024	658/1024	658/1024	658/1024	658/1024
Payload size (bits)	16392	32776	7936	16392	32776
Transport block CRC (bits)	24	24	24	24	24
Code block CRC size (bits)	24	24	-	24	24
Number of code blocks - C	2	4	1	2	4
Code block size including CRC (bits) (Note 2)	8232	8224	7960	8232	8224
Total number of bits per slot	25344	50688	12288	25344	50688
Total symbols per slot	6336	12672	3072	6336	12672
NOTE 1: <i>DM-RS configuration type = 1</i> with <i>DM-RS duration = single-symbol DM-RS</i> and the number of DM-RS CDM groups without data is 2, <i>Additional DM-RS position = pos1</i> with $l_0 = 0$ and $l = 8$ as per Table 6.4.1.1.3-3 of TS 38.211 [8].					
NOTE 2: Code block size including CRC (bits) equals to $K'$ in sub-clause 5.2.2 of TS 38.212 [9].					

**Table A.2.3-6: FRC parameters for FR2-1 PUSCH performance requirements, transform precoding disabled, *Additional DM-RS position = pos1* and 2 transmission layers (16QAM, R=658/1024)**

Reference channel	D-FR2-A.2.3-16	D-FR2-A.2.3-17	D-FR2-A.2.3-18	D-FR2-A.2.3-19	D-FR2-A.2.3-20
Subcarrier spacing [kHz]	60	60	120	120	120
Allocated resource blocks	66	132	32	66	132
CP-OFDM Symbols per slot (Note 1)	8	8	8	8	8
Modulation	16QAM	16QAM	16QAM	16QAM	16QAM
Code Rate	658/1024	658/1024	658/1024	658/1024	658/1024
Payload size (bits)	32776	65576	15880	32776	65576
Transport block CRC (bits)	24	24	24	24	24
Code block CRC size (bits)	24	24	24	24	24
Number of code blocks - C	4	8	2	4	8
Code block size including CRC (bits) (Note 2)	8224	8224	7976	8224	8224
Total number of bits per slot	50688	101376	24576	50688	101376
Total symbols per slot	12672	25344	6144	12672	25344
NOTE 1: <i>DM-RS configuration type = 1</i> with <i>DM-RS duration = single-symbol DM-RS</i> and the number of DM-RS CDM groups without data is 2, <i>Additional DM-RS position = pos1</i> with $l_0 = 0$ and $l = 8$ as per Table 6.4.1.1.3-3 of TS 38.211 [8].					
NOTE 2: Code block size including CRC (bits) equals to $K'$ in sub-clause 5.2.2 of TS 38.212 [9].					

## A.2.4 Fixed Reference Channels for PUSCH performance requirements (64QAM, R=567/1024)

The parameters for the reference measurement channels are specified in table A.2.4-1 for FR1 PUSCH performance requirements:

- FRC parameters are specified in table A.2.4-1 for FR1 PUSCH with transform precoding disabled, *Additional DM-RS position = pos1* and 1 transmission layer.

The parameters for the reference measurement channels are specified in table A.2.4-2 and table A.2.4-3 for FR2-1 PUSCH performance requirements:

- FRC parameters are specified in table A.2.4-2 for FR2-1 PUSCH with transform precoding disabled, *Additional DM-RS position = pos0* and 1 transmission layer.
- FRC parameters are specified in table A.2.4-3 for FR2-1 PUSCH with transform precoding disabled, *Additional DM-RS position = pos1* and 1 transmission layer.

**Table A.2.4-1: FRC parameters for FR1 PUSCH performance requirements, transform precoding disabled, *Additional DM-RS position = pos1* and 1 transmission layer (64QAM, R=567/1024)**

Reference channel	D-FR1-A.2.4-1	D-FR1-A.2.4-2	D-FR1-A.2.4-3	D-FR1-A.2.4-4	D-FR1-A.2.4-5	D-FR1-A.2.4-6	D-FR1-A.2.4-7
Subcarrier spacing [kHz]	15	15	15	30	30	30	30
Allocated resource blocks	25	52	106	24	51	106	273
CP-OFDM Symbols per slot (Note 1)	12	12	12	12	12	12	12
Modulation	64QAM	64QAM	64QAM	64QAM	64QAM	64QAM	64QAM
Code Rate	567/1024	567/1024	567/1024	567/1024	567/1024	567/1024	567/1024
Payload size (bits)	12040	25104	50184	11528	24576	50184	131176
Transport block CRC (bits)	24	24	24	24	24	24	24
Code block CRC size (bits)	24	24	24	24	24	24	24
Number of code blocks - C	2	3	6	2	3	6	16
Code block size including CRC (bits) (Note 2)	6056	8400	8392	5800	8224	8392	8224
Total number of bits per slot	21600	44928	91584	20736	44064	91584	235872
Total symbols per slot	3600	7488	15264	3456	7344	15264	39312
NOTE 1: <i>DM-RS configuration type = 1</i> with <i>DM-RS duration = single-symbol DM-RS</i> and the number of DM-RS CDM groups without data is 2, <i>Additional DM-RS position = pos1</i> , $l_0 = 2$ and $l = 11$ for PUSCH mapping type A, $l_0 = 0$ and $l = 10$ for PUSCH mapping type B as per table 6.4.1.1.3-3 of TS 38.211 [8].							
NOTE 2: Code block size including CRC (bits) equals to $K'$ in clause 5.2.2 of TS 38.212 [9].							

**Table A.2.4-2: FRC parameters for FR2-1 PUSCH performance requirements, transform precoding disabled, *Additional DM-RS position = pos0* and 1 transmission layer (64QAM, R=567/1024)**

Reference channel	G-FR2-A.2.4-1	G-FR2-A.2.4-2	G-FR2-A.2.4-3	G-FR2-A.2.4-4	G-FR2-A.2.4-5
Subcarrier spacing [kHz]	60	60	120	120	120
Allocated resource blocks	66	132	32	66	132
CP-OFDM Symbols per slot (Note 1)	9	9	9	9	9
Modulation	64QAM	64QAM	64QAM	64QAM	64QAM
Code Rate	567/1024	567/1024	567/1024	567/1024	567/1024
Payload size (bits)	23568	47112	11528	23568	47112
Transport block CRC (bits)	24	24	24	24	24
Code block CRC size (bits)	24	24	24	24	24
Number of code blocks - C	3	6	2	3	6
Code block size including CRC (bits) (Note 2)	7888	7880	5800	7888	7880
Total number of bits per slot	42768	85536	20736	42768	85536
Total symbols per slot	7128	14256	3456	7128	14256
NOTE 1: <i>DM-RS configuration type = 1</i> with <i>DM-RS duration = single-symbol DM-RS</i> and the number of DM-RS CDM groups without data is 2, <i>Additional DM-RS position = pos0</i> with $l_0 = 0$ as per Table 6.4.1.1.3-3 of TS 38.211 [8].					
NOTE 2: Code block size including CRC (bits) equals to $K'$ in sub-clause 5.2.2 of TS 38.212 [9].					

**Table A.2.4-3: FRC parameters for FR2-1 PUSCH performance requirements, transform precoding disabled, Additional DM-RS position = pos1 and 1 transmission layer (64QAM, R=567/1024)**

Reference channel	G-FR2-A.2.4-6	G-FR2-A.2.4-7	G-FR2-A.2.4-8	G-FR2-A.2.4-9	G-FR2-A.2.4-10
Subcarrier spacing [kHz]	60	60	120	120	120
Allocated resource blocks	66	132	32	66	132
CP-OFDM Symbols per slot (Note 1)	8	8	8	8	8
Modulation	64QAM	64QAM	64QAM	64QAM	64QAM
Code Rate	567/1024	567/1024	567/1024	567/1024	567/1024
Payload size (bits)	21000	42016	10248	21000	42016
Transport block CRC (bits)	24	24	24	24	24
Code block CRC size (bits)	24	24	24	24	24
Number of code blocks - C	3	5	2	3	5
Code block size including CRC (bits) (Note 2)	7032	8432	5160	7032	8432
Total number of bits per slot	38016	76032	18432	38016	76032
Total symbols per slot	6336	12672	3072	6336	12672
NOTE 1: DM-RS configuration type = 1 with DM-RS duration = single-symbol DM-RS and the number of DM-RS CDM groups without data is 2, Additional DM-RS position = pos1 with $l_0=0$ and $l=8$ as per Table 6.4.1.1.3-3 of TS 38.211 [8].					
NOTE 2: Code block size including CRC (bits) equals to $K'$ in sub-clause 5.2.2 of TS 38.212 [9].					

## A.2.5 PRACH Test preambles

**Table A.2.5-1: Test preambles for Normal Mode in FR1**

Burst format	SCS (kHz)	Ncs	Logical sequence index	v
0	1.25	13	22	32
A1, A2, A3, B4, C0, C2	15	23	0	0
	30	46	0	0

**Table A.2.5-2: Test preambles for Normal Mode in FR2-1**

Burst format	SCS (kHz)	Ncs	Logical sequence index	v
A1, A2, A3, B4, C0, C2	60	69	0	0
	120	69	0	0

## A.3 IAB-MT Fixed Reference Channels

### A.3.1 Fixed Reference Channels for PDSCH performance requirements (16QAM)

The parameters for the reference measurement channels are specified in table A.3.1-1 for FR1 PDSCH performance requirements.

The parameters for the reference measurement channels are specified in table A.3.1-2 for FR2-1 PDSCH performance requirements.

**Table A.3.1-1: FRC parameters for FR1 PDSCH performance requirements, 1-4 transmission layers, 16QAM**

Parameter	Unit	Value		
		M-FR1-A.3.1-1	M-FR1-A.3.1-2	M-FR1-A.3.1-3
Reference channel				
Channel bandwidth	MHz	40	40	40
Subcarrier spacing	kHz	30	30	30
Allocated resource blocks	PRBs	106	106	106
Number of consecutive PDSCH symbols		12	12	12
MCS table		64QAM	64QAM	64QAM
MCS index		13	13	13
Modulation		16QAM	16QAM	16QAM
Target Coding Rate		0.48	0.48	0.48
Number of MIMO layers		1	3	4
Number of DMRS REs		12	24	24
Overhead for TBS determination		0	0	0
Information Bit Payload per Slot		26632	73776	98376
Transport block CRC per Slot		24	24	24
Number of Code Blocks per Slot		4	9	12
Binary Channel Bits Per Slot		55968	152640	203520

**Table A.3.1-2: FRC parameters for FR2-1 PDSCH performance requirements, 1-2 transmission layers, 16QAM**

Parameter	Unit	Value		
		M-FR2-A.3.1-1	M-FR2-A.3.1-2	M-FR2-A.3.1-3
Reference channel				
Channel bandwidth	MHz	50	100	100
Subcarrier spacing	kHz	60	120	120
Allocated resource blocks	PRBs	66	66	66
Number of consecutive PDSCH symbols		13	13	13
MCS table		64QAM	64QAM	64QAM
MCS index		13	13	13
Modulation		16QAM	16QAM	16QAM
Target Coding Rate		0.48	0.48	0.48
Number of MIMO layers		2	1	2
Number of DMRS REs		12	12	12
Overhead for TBS determination		6	6	6
Information Bit Payload per Slot		34816	17424	34816
Transport block CRC per Slot		24	24	24
Number of Code Blocks per Slot		5	3	5
Binary Channel Bits Per Slot		73128	36564	73128

### A.3.2 Fixed Reference Channels for PDSCH performance requirements (64QAM)

The parameters for the reference measurement channels are specified in table A.3.2-1 for FR1 PDSCH performance requirements.

The parameters for the reference measurement channels are specified in table A.3.2-2 for FR2-1 PDSCH performance requirements.



**Table A.3.2-1: FRC parameters for FR1 PDSCH performance requirements, 2 transmission layers, 64QAM**

Parameter	Unit	Value
Reference channel		M-FR1-A.3.2-1
Channel bandwidth	MHz	40
Subcarrier spacing	kHz	30
Allocated resource blocks	PRBs	106
Number of consecutive PDSCH symbols		12
MCS table		64QAM
MCS index		19
Modulation		64QAM
Target Coding Rate		0.51
Number of MIMO layers		2
Number of DMRS REs		12
Overhead for TBS determination		0
Information Bit Payload per Slot		83976
Transport block CRC per Slot		24
Number of Code Blocks per Slot		10
Binary Channel Bits Per Slot		167904

**Table A.3.2-2: FRC parameters for FR2-1 PDSCH performance requirements, 1-2 transmission layers, 64QAM**

Parameter	Unit	Value	
Reference channel		M-FR2-A.3.2-1	M-FR2-A.3.2-2
Channel bandwidth	MHz	100	100
Subcarrier spacing	kHz	120	120
Allocated resource blocks	PRBs	66	66
Number of consecutive PDSCH symbols		13	13
MCS table		64QAM	64QAM
MCS index		18	17
Modulation		64QAM	64QAM
Target Coding Rate		0.46	0.43
Number of MIMO layers		1	2
Number of DMRS REs		12	12
Overhead for TBS determination		6	6
Information Bit Payload per Slot		25104	47112
Transport block CRC per Slot		24	24
Number of Code Blocks per Slot		3	6
Binary Channel Bits Per Slot		54846	109692

### A.3.3 Fixed Reference Channels for PDSCH performance requirements (256QAM)

The parameters for the reference measurement channels are specified in table A.3.3-1 for FR1 PDSCH performance requirements.

**Table A.3.3-1: FRC parameters for FR1 PDSCH performance requirements, 1 transmission layer, 256QAM**

Parameter	Unit	Value
Reference channel		M-FR1-A.3.3-1
Channel bandwidth	MHz	40
Subcarrier spacing	kHz	30
Allocated resource blocks	PRBs	106
Number of consecutive PDSCH symbols		12
MCS table		256QAM
MCS index		24
Modulation		256QAM
Target Coding Rate		0.82
Number of MIMO layers		1
Number of DMRS REs		12
Overhead for TBS determination		0
Information Bit Payload per Slot		92200
Transport block CRC per Slot		24
Number of Code Blocks per Slot		11
Binary Channel Bits Per Slot		111936

### A.3.4 Fixed Reference Channels for PDCCH performance requirements

The parameters for the reference measurement channels are specified in table A.3.4-1 for FR1 PDCCH performance requirements.

The parameters for the reference measurement channels are specified in table A.3.4-2 for FR2-1 PDCCH performance requirements.

**Table A.3.4-1: FR1 PDCCH Reference Channels**

Parameter	Unit	Value		
		M-FR1-A.3.4-1	M-FR1-A.3.4-2	M-FR1-A.3.4-3
Reference channel		M-FR1-A.3.4-1	M-FR1-A.3.4-2	M-FR1-A.3.4-3
Subcarrier spacing	kHz	30	30	30
CORESET frequency domain allocation		102	102	90
CORESET time domain allocation		1	1	1
Aggregation level		2	4	8
DCI Format		1_0	1_1	1_1
Payload (without CRC)	Bits	41	53	53

Table A.3.4-2: FR2-1 PDCCH Reference Channels

Parameter	Unit	Value		
		M-FR2-A.3.4-1	M-FR2-A.3.4-2	M-FR2-A.3.4-3
Reference channel				
Subcarrier spacing	kHz	120	120	120
CORESET frequency domain allocation		60	60	60
CORESET time domain allocation		1	1	1
Aggregation level		2	4	8
DCI Format		1_0	1_1	1_1
Payload (without CRC)	Bits	40	56	56

### A.3.5 Fixed Reference Channels for CSI reporting performance

This clause defines the DL signal applicable to the reporting of channel status information.

Tables in this clause specifies the mapping of CQI index to Information Bit payload, which complies with the CQI definition specified in clause 5.2.2.1 of TS 38.214 [11] and with MCS definition specified in clause 5.1.3 of TS 38.214 [11].

Table A.3.5-1: Fixed Reference Channels for FR1 CSI reporting with CQI table 2 and MCS table 2

Reference channel				M-FR1-A.3.5-1	M-FR1-A.3.5-2	M-FR1-A.3.5-3	M-FR1-A.3.5-4
Number of allocated PDSCH resource blocks				106	106	106	106
Number of consecutive PDSCH symbols				12	12	12	12
Number of PDSCH MIMO layers				1	2	3	4
Number of DMRS REs (Note 1)				24	24	24	24
Overhead for TBS determination				0	0	0	0
Available RE-s for PDSCH				12720	12720	12720	12720
CQI index	Spectral efficiency	MCS index	Modulation	Information Bit Payload per Slot			
0	OOOR	OOOR	OOOR	N/A	N/A	N/A	N/A
1	0.1523	0	QPSK	2976	5896	8976	11784
2	0.3770	1		4744	9480	14344	18976
3	0.8770	3		11016	22536	33816	45096
4	1.4766	5	16QAM	18960	37896	56368	75792
5	1.9141	7		24576	49176	73776	98376
6	2.4063	9		30728	61480	92200	122976
7	2.7305	11	64QAM	34816	69672	104496	139376
8	3.3223	13		42016	83976	127080	167976
9	3.9023	15		49176	98376	147576	196776
10	4.5234	17	256QAM	57376	114776	172176	229576
11	5.1152	19		65576	131176	196776	262376
12	5.5547	21		69672	139376	213176	278776
13	6.2266	23		79896	159880	237776	319784
14	6.9141	25		88064	176208	262376	352440
15	7.4063	27	94248	188576	278776	376896	

NOTE 1: Number of DMRS REs includes the overhead of the DM-RS CDM groups without data  
NOTE 2: PDSCH is only scheduled on slots which are full DL

**Table A.3.5-2: Fixed Reference Channels for FR2-1 CSI reporting with CQI table 1 and MCS table 1**

Reference channel				M-FR2-A.3.5-1	M-FR2-A.3.5-2
Number of allocated PDSCH resource blocks				66	66
Number of consecutive PDSCH symbols				12	12
Number of PDSCH MIMO layers				1	2
Number of DMRS REs (Note 1)				24	24
Overhead for TBS determination				6	6
Available RE-s				7590	7590
CQI index	Spectral efficiency	MCS index	Modulation	Information Bit Payload per Slot	
0	OOOR	OOOR	OOOR	N/A	N/A
1	0.1523	0	QPSK	1800	3624
2	0.2344	0		1800	3624
3	0.3770	2		2856	5640
4	0.6016	4		4480	8968
5	0.8770	6		6528	13064
6	1.1758	8		8712	17928
7	1.4766	11	16QAM	11016	22032
8	1.9141	13		14343	28680
9	2.4063	15		17928	35856
10	2.7305	18	64QAM	20496	40976
11	3.3223	20		25104	50184
12	3.9023	22		29192	58384
13	4.5234	24		33816	67584
14	5.1152	26		38936	77896
15	5.5547	28		42016	83976

NOTE 1: Number of DMRS REs includes the overhead of the DM-RS CDM groups without data  
 NOTE 2: PDSCH is only scheduled on slots which are full DL

**Table A.3.5-3: PDSCH Reference Channel for FR1 PMI reporting requirements**

Parameter	Unit	Value	
		M-FR1-A.3.5-5	M-FR1-A.3.5-6
Reference channel			
Channel bandwidth	MHz	40	40
Subcarrier spacing	kHz	30	30
Allocated resource blocks	PRBs	106	106
Number of consecutive PDSCH symbols		12	12
MCS table		64QAM	64QAM
MCS index		13	13
Modulation		16QAM	16QAM
Target Coding Rate		0.48	0.48
Number of MIMO layers		1	2
Number of DMRS REs (Note 3)		24	24
Overhead for TBS determination		0	0
Information Bit Payload per Slot	Bits	24576	49176
For Slot $i = 20$			
Transport block CRC per Slot	Bits	24	24
Number of Code Blocks per Slot	CBs	3	6
Binary Channel Bits Per Slot	Bits	50880	101760

**Table A.3.5-4: PDSCH Reference Channel for FR2-1 PMI reporting requirements**

<b>Parameter</b>	<b>Unit</b>	<b>Value</b>
Reference channel		M-FR2-A.3.5-3
Channel bandwidth	MHz	100
Subcarrier spacing	kHz	120
Allocated resource blocks	PRBs	66
Number of consecutive PDSCH symbols		12
MCS table		64QAM
MCS index		13
Modulation		16QAM
Target Coding Rate		0.48
Number of MIMO layers		1
Number of DMRS REs (Note 3)		24
Overhead for TBS determination		6
Information Bit Payload per Slot		14344
Transport block CRC per Slot		24
Number of Code Blocks per Slot		2
Binary Channel Bits Per Slot		30360

---

## Annex B (normative): IAB-DU Error Vector Magnitude (FR1)

The Annex B in TS 38.104 [2] applies to FR1 IAB-DU.

---

## Annex C (normative): IAB-DU Error Vector Magnitude (FR2-1)

The Annex C in TS 38.104 [2] applies to FR2 IAB-DU.

---

## Annex D (normative): IAB-MT Error Vector Magnitude (FR2-1)

### D.0 General

FR1 IAB-MT EVM can be determined by the process according to

1) Annex E in TS 38.521-1 [23]. Only CP-OFDM waveform of PUSCH is measured for IAB-MT.

Or

2) Annex D.1 to Annex D.7.

### D.1 Reference point for measurement

The Annex B.1 in TS 38.104 [2] applies to FR1 IAB-MT.

### D.2 Basic unit of measurement

The Annex B.2 in TS 38.104 [2] applies to FR1 IAB-MT.

### D.3 Modified signal under test

The Annex B.3 in TS 38.104 [2] applies to FR1 IAB-MT.

### D.4 Estimation of frequency offset

The Annex B.4 in TS 38.104 [2] applies to FR1 IAB-MT.

### D.5 Estimation of time offset

The Annex B.5 in TS 38.104 [2] applies to FR1 IAB-MT.

### D.6 Estimation of TX chain amplitude and frequency response parameters

The Annex B.6 in TS 38.104 [2] applies to FR1 IAB-MT.

### D.7 Averaged EVM

EVM is averaged over all allocated uplink resource blocks with the considered modulation scheme in the frequency domain, and a minimum of  $N_{ul}$  slots where  $N_{ul}$  is the number of slots in a 10 ms measurement interval.

For TDD, let  $N_{ul}^{TDD}$  be the number of slots with uplink symbols within a 10 ms measurement interval, the averaging in the time domain can be calculated from  $N_{ul}^{TDD}$  slots of different 10 ms measurement intervals and should have a minimum of  $N_{ul}$  slots averaging length where  $N_{ul}$  is the number of slots in a 10 ms measurement interval.

- $\overline{EVM}_{\text{frame}}$  is derived by: Square the EVM results in each 10 ms measurement interval. Sum the squares, divide the sum by the number of EVM relevant locations, square-root the quotient (RMS).



$$\overline{EVM}_{\text{frame}} = \sqrt{\frac{1}{\sum_{i=1}^{N_{ul}^{TDD}} N_i} \sum_{i=1}^{N_{ul}^{TDD}} \sum_{j=1}^{N_i} EVM_{i,j}^2}$$

- Where  $N_i$  is the number of resource blocks with the considered modulation scheme in slot  $i$ .
- The  $\overline{EVM}_{\text{frame}}$  is calculated, using the maximum of  $\overline{EVM}_{\text{frame}}$  at the window  $W$  extremities. Thus  $\overline{EVM}_{\text{frame},l}$  is calculated using  $\tilde{t} = \Delta\tilde{t}_l$  and  $\overline{EVM}_{\text{frame},h}$  is calculated using  $\tilde{t} = \Delta\tilde{t}_h$  ( $l$  and  $h$ , low and high; where low is the timing  $(\Delta c - W/2)$  and high is the timing  $(\Delta c + W/2)$ ).

$$EVM_{\text{frame}} = \max(\overline{EVM}_{\text{frame},l}, \overline{EVM}_{\text{frame},h})$$

- In order to unite at least  $N_{ul}$  slots, consider the minimum integer number of 10 ms measurement intervals, where  $N_{\text{frame}}$  is determined by.

$$N_{\text{frame}} = \left\lceil \frac{10 \times N_{\text{slot}}}{N_{ul}^{TDD}} \right\rceil$$

and  $N_{\text{slot}} = 1$  for 15 kHz SCS,  $N_{\text{slot}} = 2$  for 30 kHz SCS and  $N_{\text{slot}} = 4$  for 60 kHz SCS normal CP.

- Unite by RMS.

$$\overline{EVM} = \sqrt{\frac{1}{N_{\text{frame}}} \sum_{k=1}^{N_{\text{frame}}} EVM_{\text{frame},k}^2}$$

---

## Annex E (normative): IAB-MT Error Vector Magnitude (FR2)

### E.0 General

FR2-1 IAB-MT EVM can be determined by the process according to

1) Annex E in TS 38.521-2 [24]. Only CP-OFDM waveform of PUSCH is measured for IAB-MT.

Or

2) Annex E.1 to Annex E.7.

### E.1 Reference point for measurement

The Annex C.1 in TS 38.104 [2] applies to FR2-1 IAB-MT.

### E.2 Basic unit of measurement

The Annex C.2 in TS 38.104 [2] applies to FR2-1 IAB-MT.

### E.3 Modified signal under test

The Annex C.3 in TS 38.104 [2] applies to FR2-1 IAB-MT.

### E.4 Estimation of frequency offset

The Annex C.4 in TS 38.104 [2] applies to FR2-1 IAB-MT.

### E.5 Estimation of time offset

The Annex C.5 in TS 38.104 [2] applies to FR2-1 IAB-MT.

### E.6 Estimation of TX chain amplitude and frequency response parameters

The Annex C.6 in TS 38.104 [2] applies to FR2-1 IAB-MT.

### E.7 Averaged EVM

EVM is averaged over all allocated uplink resource blocks with the considered modulation scheme in the frequency domain, and a minimum of  $N_{ul}$  slots where  $N_{ul}$  is the number of slots in a 10 ms measurement interval.

For TDD, let  $N_{ul}^{TDD}$  be the number of slots with uplink symbols within a 10 ms measurement interval, the averaging in the time domain can be calculated from  $N_{ul}^{TDD}$  slots of different 10 ms measurement intervals and should have a minimum of  $N_{ul}$  slots averaging length where  $N_{ul}$  is the number of slots in a 10 ms measurement interval.

- $\overline{EVM}_{\text{frame}}$  is derived by: Square the EVM results in each 10 ms measurement interval. Sum the squares, divide the sum by the number of EVM relevant locations, square-root the quotient (RMS).

$$\overline{EVM}_{\text{frame}} = \sqrt{\frac{1}{\sum_{i=1}^{N_{ul}^{TDD}} N_i} \sum_{i=1}^{N_{ul}^{TDD}} \sum_{j=1}^{N_i} EVM_{i,j}^2}$$

- Where  $N_i$  is the number of resource blocks with the considered modulation scheme in slot  $i$ .
- The  $\overline{EVM}_{\text{frame}}$  is calculated, using the maximum of  $\overline{EVM}_{\text{frame}}$  at the window  $W$  extremities. Thus  $\overline{EVM}_{\text{frame},l}$  is calculated using  $\tilde{t} = \Delta\tilde{t}_l$  and  $\overline{EVM}_{\text{frame},h}$  is calculated using  $\tilde{t} = \Delta\tilde{t}_h$  ( $l$  and  $h$ , low and high; where low is the timing  $(\Delta c - W/2)$  and high is the timing  $(\Delta c + W/2)$ ).

$$EVM_{\text{frame}} = \max(\overline{EVM}_{\text{frame},l}, \overline{EVM}_{\text{frame},h})$$

- In order to unite at least  $N_{ul}$  slots, consider the minimum integer number of 10 ms measurement intervals, where  $N_{\text{frame}}$  is determined by.

$$N_{\text{frame}} = \left\lceil \frac{10 \times N_{\text{slot}}}{N_{ul}^{TDD}} \right\rceil$$

and  $N_{\text{slot}} = 4$  for 60 kHz SCS and  $N_{\text{slot}} = 8$  for 120 kHz SCS.

- Unite by RMS.

$$\overline{EVM} = \sqrt{\frac{1}{N_{\text{frame}}} \sum_{k=1}^{N_{\text{frame}}} EVM_{\text{frame},k}^2}$$

---

## Annex F (normative):

### F.1 Characteristics of the interfering signals for IAB-DU

The Annex D in in TS 38.104 [2] apply to FR1 IAB-DU.

### F.2 Characteristics of the interfering signals for IAB-MT

*The interfering signal shall be configured with PDSCH and PDCCH containing data and DM-RS symbols. Normal cyclic prefix is used. The data content shall be uncorrelated to the wanted signal and modulated according to clause 7 of TS38.211 [8]. Mapping of PDSCH modulation to receiver requirement are specified in table F-1.*

**Table F-1: Modulation of the interfering signal**

<b>Receiver requirement</b>	<b>Modulation</b>
Adjacent channel selectivity and narrow-band blocking	QPSK
General blocking	QPSK
Receiver intermodulation	QPSK

---

## Annex G (normative): IAB-MT RRM Testing

The test cases defined in this Annex are to verify the minimum requirements defined in clause 12. The conducted tests are performed for IAB type 1-H, and the over the air (OTA) tests are performed for IAB type 2-O, where the conducted and radiated reference points and the IAB type are defined in clause 4.3. For the test cases for IAB-MT, the DU part is disabled during the testing. The test cases apply for Local-area IAB-MT classes, where the IAB-MT classes are defined in clause 4.4.

The test configurations and procedures are defined in following clauses and in each test cases. The test requirements are derived using the corresponding configuration parameters as example. The actual IAB-MT RRM test can be conducted by any set of configuration parameters which are left to implementations and manufacturer declarations and the corresponding test requirements shall be based on the actual configuration parameters used in the test. For example, TDD pattern and related configurations shall be configurable and left for implementation and declaration including:

- DL/UL scheduling related configuration
- PRACH configuration
- SRS configuration
- SSB configuration
- CSI-RS configuration
- BWP configuration
- SMTC configuration
- TCI state configuration
- Antenna configuration
- AoA configuration

## G.1 IAB-MT RRM test configurations

### G.1.1 Reference measurement channels

#### G.1.1.1 PDSCH

##### G.1.1.1.1 TDD

**Table G.1.1.1.1-1: PDSCH Reference Measurement Channels for SCS=15kHz**

Parameter	Unit	Value						
Reference channel		SR.1.1 TDD						
Channel bandwidth	MHz	10						
Number of transmitter antennas		1						
Allocated resource blocks for PDSCH <sup>Note 1</sup>		24						
Allocated slots per Radio Frame								
Radio frame containing SSB	slots	Note 5						
Radio frame not containing SSB	slots	4						
MCS table		64QAM						
MCS index		4						
Modulation		QPSK						
Target Coding Rate		1/3						
Number of control symbols		2						
PDSCH mapping type		Type A						
Information Bit Payload								
For slots with RMSI <sup>Note 2</sup>	bits	1608						
For slots without RMSI	bits	1864						
Number of Code Blocks per slot		1						
Binary Channel Bits Per slot								
For slots with RMSI <sup>Note 2, Note 4</sup>	bits	5184						
For slots without RMSI <sup>Note 6</sup>	bits	6048						
<p>Note 1: Allocated outside the SMTTC duration in time and in resource blocks which do not overlap with the resource blocks allocated for SS/PBCH block.</p> <p>Note 2: PDSCH is scheduled on the slots with RMSI.</p> <p>Note 3: If necessary the information bit payload size can be adjusted to facilitate the test implementation. The payload sizes are defined in TS 38.213 [3].</p> <p>Note 4: Derived based on the PDSCH DMRS assumption: dmrs-TypeA-Position=2, dmrs-Type=1, dmrs-AdditionalPositions=2, maxLength=1, Antenna port index: 1000, and Number of PDSCH DMRS CDM group(s) without data: 2.</p> <p>Note 5: PDSCH is not scheduled in slots containing SSB according to the SSB configuration used in the test. SSB configurations are defined in clause G.1.5.</p> <p>Note 6: Derived based on the PDSCH DMRS assumption: dmrs-TypeA-Position=2, dmrs-Type=1, dmrs-AdditionalPositions=2, maxLength=1, Antenna port index: 1000, and Number of PDSCH DMRS CDM group(s) without data: 1.</p>								

**Table G.1.1.1.1-2: PDSCH Reference Measurement Channels for SCS=30kHz**

Parameter	Unit	Value					
Reference channel		SR.2.1 TDD					
Channel bandwidth	MHz	40					
Number of transmitter antennas		1					
Allocated resource blocks for PDSCH <sup>Note 1</sup>		24					
Allocated slots per Radio Frame							
Radio frame containing SSB	slots	Note 5					
Radio frame not containing SSB	slots	10					
MCS table		64QAM					
MCS index		4					
Modulation		QPSK					
Target Coding Rate		1/3					
Number of control symbols		2					
PDSCH mapping type		Type A					
Information Bit Payload							
For slots with RMSI <sup>Note 2</sup>	bits	1608					
For slots without RMSI	bits	1864					
Number of Code Blocks per slot		1					
Binary Channel Bits Per slot							
For slots with RMSI <sup>Note 2, Note 4</sup>	bits	5184					
For slots without RMSI <sup>Note 6</sup>	bits	6048					
<p>Note 1: Allocated outside the SMTC duration in time and in resource blocks which do not overlap with the resource blocks allocated for SS/PBCH block.</p> <p>Note 2: PDSCH is scheduled on the slots with RMSI.</p> <p>Note 3: If necessary the information bit payload size can be adjusted to facilitate the test implementation. The payload sizes are defined in TS 38.213 [3].</p> <p>Note 4: Derived based on the PDSCH DMRS assumption: dmrs-TypeA-Position=2, dmrs-Type=1, dmrs-AdditionalPositions=2, maxLength=1, Antenna port index: 1000, and Number of PDSCH DMRS CDM group(s) without data: 2.</p> <p>Note 5: PDSCH is not scheduled in slots containing SSB according to the SSB configuration used in the test. SSB configurations are defined in clause G.1.5.</p> <p>Note 6: Derived based on the PDSCH DMRS assumption: dmrs-TypeA-Position=2, dmrs-Type=1, dmrs-AdditionalPositions=2, maxLength=1, Antenna port index: 1000, and Number of PDSCH DMRS CDM group(s) without data: 1.</p>							

**Table G.1.1.1.1-3: PDSCH Reference Measurement Channels for SCS=120kHz**

Parameter	Unit	Value					
Reference channel		SR.3.1 TDD					
Channel bandwidth	MHz	100					
Number of transmitter antennas		1					
Allocated resource blocks for PDSCH <sup>Note 1</sup>		24					
Allocated slots per Radio Frame							
Radio frame containing SSB	slots	Note 5					
Radio frame not containing SSB	slots	48					
MCS table		64QAM					
MCS index		4					
Modulation		QPSK					
Target Coding Rate		1/3					
Number of control symbols		2					
PDSCH mapping type		Type A					
Information Bit Payload							
For slots with RMSI <sup>Note 2</sup>	bits	1608					
For slots without RMSI	bits	1864					
Number of Code Blocks per slot		1					
Binary Channel Bits Per slot							
For slots with RMSI <sup>Note 2, Note 4</sup>	bits	5184					
For slots without RMSI <sup>Note 6</sup>	bits	6048					
<p>Note 1: Allocated outside the SMTC duration in time and in resource blocks which do not overlap with the resource blocks allocated for SS/PBCH block</p> <p>Note 2: PDSCH is scheduled on the slots with RMSI.</p> <p>Note 3: If necessary the information bit payload size can be adjusted to facilitate the test implementation. The payload sizes are defined in TS 38.213 [3].</p> <p>Note 4: Derived based on the PDSCH DMRS assumption: dmrs-TypeA-Position=2, dmrs-Type=1, dmrs-AdditionalPositions=2, maxLength=1, Antenna port index: 1000, and Number of PDSCH DMRS CDM group(s) without data: 2.</p> <p>Note 5: PDSCH is not scheduled in slots containing SSB according to the SSB configuration used in the test. SSB configurations are defined in clause G.1.5.</p> <p>Note 6: Derived based on the PDSCH DMRS assumption: dmrs-TypeA-Position=2, dmrs-Type=1, dmrs-AdditionalPositions=2, maxLength=1, Antenna port index: 1000, and Number of PDSCH DMRS CDM group(s) without data: 1.</p>							



G.1.1.2 CORESET for RMSI scheduling

G.1.1.2.1 TDD

**Table G.1.1.2.1-1: RMSI CORESET Reference Channel for TDD with SCS=15KHz**

Parameter	Unit	Value					
Reference channel		CR.1.1 TDD					
Channel bandwidth	MHz	10					
Subcarrier spacing	kHz	15					
Allocated resource blocks for RMSI CORESET <sup>Note 7</sup>		24					
SSB and RMSI CORESET multiplexing configuration <sup>Note 7</sup>		Pattern 1					
Offset between SSB and RMSI CORESET <sup>Note 3, 7</sup>	RB	0 (Note 8)					
Configuration of PDCCH monitoring occasions for RMSI CORESET <sup>Note 4</sup>		Index 4					
Number of transmitter antennas		1					
Duration of RMSI CORESET <sup>Note 7</sup>	symbols	2					
DCI Format <sup>Note 1</sup>		Note 2					
Aggregation level	CCE	8					
DMRS precoder granularity		6					
REG bundle size		6					
Mapping from REG to CCE		Distributed					
Cell ID		Note 5					
Payload (without CRC)	bits	Note 6					
<p>Note 1: DCI formats are defined in TS 38.212.</p> <p>Note 2: DCI format shall depend upon the test configuration.</p> <p>Note 3: The offset is defined with respect to the subcarrier spacing of the CORESET from the smallest RB index of RMSI CORESET to the smallest RB index of the common RB overlapping with the first RB of the SS/PBCH block.</p> <p>Note 4: The configuration of PDCCH monitoring occasions for RMSI CORESET is defined in Table 13-11 in TS 38.213 [3].</p> <p>Note 5: Cell ID shall depend upon the test configuration.</p> <p>Note 6: Payload size shall depend upon the test configuration.</p> <p>Note 7: The configuration of set of resource blocks and slot symbols of control resource set for Type0-PDCCH search space corresponds to index 0 in Table 13-1 in TS 38.213 [3].</p> <p>Note 8: Other values can be used to align with GSCN [13] as long as SSB does not overlap the RMC.</p>							

**Table G.1.1.2.1-2: RMSI CORESET Reference Channel for TDD with SCS=30KHz**

Parameter	Unit	Value					
Reference channel		CR.2.1 TDD					
Channel bandwidth	MHz	40					
Subcarrier spacing	kHz	30					
Allocated resource blocks for RMSI CORESET <sup>Note 7</sup>		24					
SSB and RMSI CORESET multiplexing configuration <sup>Note 7</sup>		Pattern 1					
Offset between SSB and RMSI CORESET <sup>Note 3, 7</sup>	RB	0 (Note 8)					
Configuration of PDCCH monitoring occasions for RMSI CORESET <sup>Note 4</sup>		Index 4					
Number of transmitter antennas		1					
Duration of RMSI CORESET <sup>Note 7</sup>	symbols	2					
DCI Format <sup>Note 1</sup>		Note 2					
Aggregation level	CCE	8					
DMRS precoder granularity		6					
REG bundle size		6					
Mapping from REG to CCE		Distributed					
Cell ID		Note 5					
Payload (without CRC)	bits	Note 6					
<p>Note 1: DCI formats are defined in TS 38.212.</p> <p>Note 2: DCI format shall depend upon the test configuration.</p> <p>Note 3: The offset is defined with respect to the subcarrier spacing of the CORESET from the smallest RB index of RMSI CORESET to the smallest RB index of the common RB overlapping with the first RB of the SS/PBCH block.</p> <p>Note 4: The configuration of PDCCH monitoring occasions for RMSI CORESET is defined in Table 13-11 in TS 38.213 [3].</p> <p>Note 5: Cell ID shall depend upon the test configuration.</p> <p>Note 6: Payload size shall depend upon the test configuration.</p> <p>Note 7: The configuration of set of resource blocks and slot symbols of control resource set for Type0-PDCCH search space corresponds to index 0 in Table 13-6 in TS 38.213 [3].</p> <p>Note 8: Other values can be used to align with GSCN [13] as long as SSB does not overlap the RMC.</p>							

**Table G.1.1.2.1-3: RMSI CORESET Reference Channel for TDD with SCS=120KHz**

Parameter	Unit	Value					
Reference channel		CR.3.1 TDD					
Channel bandwidth	MHz	100					
Subcarrier spacing	kHz	120					
Allocated resource blocks for RMSI CORESET <sup>Note 7</sup>		24					
SSB and RMSI CORESET multiplexing configuration <sup>Note 7</sup>		Pattern 1					
Offset between SSB and RMSI CORESET <sup>Note 3, 7</sup>	RB	0 (Note 8)					
Configuration of PDCCH monitoring occasions for RMSI CORESET <sup>Note 4</sup>		Index 4					
Number of transmitter antennas		1					
Duration of RMSI CORESET <sup>Note 7</sup>	symbols	2					
DCI Format <sup>Note 1</sup>		Note 2					
Aggregation level	CCE	8					
DMRS precoder granularity		6					
REG bundle size		6					
Mapping from REG to CCE		Distributed					
Cell ID		Note 5					
Payload (without CRC)	bits	Note 6					
<p>Note 1: DCI formats are defined in TS 38.212.</p> <p>Note 2: DCI format shall depend upon the test configuration.</p> <p>Note 3: The offset is defined with respect to the subcarrier spacing of the CORESET from the smallest RB index of RMSI CORESET to the smallest RB index of the common RB overlapping with the first RB of the SS/PBCH block.</p> <p>Note 4: The configuration of PDCCH monitoring occasions for RMSI CORESET is defined in Table 13-12 in TS 38.213 [3].</p> <p>Note 5: Cell ID shall depend upon the test configuration.</p> <p>Note 6: Payload size shall depend upon the test configuration.</p> <p>Note 7: The configuration of set of resource blocks and slot symbols of control resource set for Type0-PDCCH search space corresponds to index 0 in Table 13-8 in TS 38.213 [3].</p> <p>Note 8: Other values can be used to align with GSCN [13] as long as SSB does not overlap the RMC.</p>							

G.1.1.3 CORESET for RMC scheduling

G.1.1.3.1 TDD

**Table G.1.1.3.1-1: Control Channel RMC for TDD with SCS=15KHz**

Parameter	Unit	Value					
		CCR.1.1 TDD	CCR.1.2 TDD				
Reference channel							
Subcarrier spacing	kHz	15	15				
Allocated resource blocks for CORESET <small>Note 3</small>		24	18				
Number of transmitter antennas		1	1				
Duration of CORESET	symbols	2	2				
REG bundle size		6	6				
DMRS precoder granularity		Same as REG bundle size	Same as REG bundle size				
CCE to REG mapping		Interleaved	Interleaved				
Interleave n_shift		0	0				
Interleave size		2	2				
Beamforming Pre-Coder		N/A	N/A				
Aggregation level	CCE	8	4				
DCI formats		Note 1	Note 1				
Payload size (without CRC)	bits	Note 2	Note 2				
Note 1: DCI format shall depend upon the test configuration. Note 2: Payload size shall depend upon the test configuration. Note 3: Allocated in the resource blocks where the associated RMC is scheduled.							

**Table G.1.1.3.1-2: Control Channel RMC for TDD with SCS=30KHz**

Parameter	Unit	Value					
		CCR.2.1 TDD					
Reference channel							
Subcarrier spacing	kHz	30					
Allocated resource blocks for CORESET <small>Note 3</small>		24					
Number of transmitter antennas		1					
Duration of CORESET	symbols	2					
REG bundle size		6					
DMRS precoder granularity		Same as REG bundle size					
CCE to REG mapping		Interleaved					
Interleave n_shift		0					
Interleave size		2					
Beamforming Pre-Coder		N/A					
Aggregation level	CCE	8					
DCI formats		Note 1					
Payload size (without CRC)	bits	Note 2					
Note 1: DCI format shall depend upon the test configuration. Note 2: Payload size shall depend upon the test configuration. Note 3: Allocated in the same resource blocks where the associated RMC is scheduled.							

**Table G.1.1.3.1-3: Control Channel RMC for TDD with SCS=120KHz**

Parameter	Unit	Value					
		CCR.3.1 TDD	CCR.3.2 TDD	CCR.3.3 TDD			
Reference channel							
Subcarrier spacing	kHz	120	120	120			
Allocated resource blocks for CORESET <sup>Note 3</sup>		24	24	24			
Number of transmitter antennas		1	1	1			
monitoringSlotPeriodicityAndOffset		sl160 0	sl160 0	sl160 80			
monitoringSymbolsWithinSlot		1100000 0000000	0011000 0000000	1100000 0000000			
Duration of CORESET	slot	1	1	1			
REG bundle size		6	6	6			
DMRS precoder granularity		Same as REG bundle size	Same as REG bundle size	Same as REG bundle size			
CCE to REG mapping		Interleaved	Interleaved	Interleaved			
Interleave n_shift		0	0	0			
Interleave size		2	2	2			
Beamforming Pre-Coder		N/A	N/A	N/A			
Aggregation level	CCE	8	8	8			
DCI formats		Note 1	Note 1	Note 1			
Payload size (without CRC)	bits	Note 2	Note 2	Note 2			
Note 1: DCI format shall depend upon the test configuration.							
Note 2: Payload size shall depend upon the test configuration.							
Note 3: Allocated in the same resource blocks where the associated PDSCH RMC is scheduled.							

## G.1.2 OFDMA channel noise generator (OCNG)

### G.1.2.1 Generic OFDMA Channel Noise Generator (OCNG)

The OCNG pattern is used in a test for modelling allocations of unused resources in the channel bandwidth to virtual IAB-MTs (which are not under test). The OCNG pattern comprises PDCCH and PDSCH transmissions to the virtual IAB-MTs.

#### G.1.2.1.1 OCNG pattern 1: Generic OCNG pattern for all unused REs

**Table G.1.2.1.1-1: OP.1: Generic OCNG pattern for all unused REs**

OCNG Parameters	Control Region	Data Region
Resource allocation	Unused REs (Note 1)	Unused REs (Note 2)
Channel	PDCCH	PDSCH
Contents	Virtual IAB-MT IDs	Uncorrelated pseudo random QPSK modulated data
Antenna transmission scheme	Same as used in PDCCH RMC	Same as used in PDSCH RMC
Subcarrier spacing	Same as used in PDCCH RMC	Same as used in PDSCH RMC
Aggregation level	Same as used in PDCCH RMC	N/A
Code rate	Same as used in PDCCH RMC	Same as used in PDSCH RMC
Transmit Power	Same as used in PDCCH RMC	Same as used in PDSCH RMC
CP length	Same as used in PDCCH RMC	Same as used in PDSCH RMC
Note 1: REs not used in the active CORESETs where PDCCH is scheduled for the IAB-MT under test.		
Note 2: REs not allocated to any physical channels, CORESET, SSB or any other reference signal within the channel bandwidth of the cell.		

## G.1.2.1.2 OCNG pattern 2: Generic OCNG pattern for all unused REs for 2AoA setup

**Table G.1.2.1.2-1: OP.2: Generic OCNG pattern for all unused REs for 2AoA setup**

OCNG Parameters	Control Region	Data Region
Probe	Transmitting the serving beam	
Resource allocation	Unused REs (Note 1) in the symbols where SSB/CSI-RS are not transmitted from both the serving beam probe and non-serving beam probe.	Unused REs (Note 2) in the symbols where SSB/CSI-RS are not transmitted from both the serving beam probe and non-serving beam probe.
Channel	PDCCH	PDSCH
Contents	Virtual IAB-MT IDs	Uncorrelated pseudo random QPSK modulated data
Antenna transmission scheme	Same as used in PDCCH RMC	Same as used in PDSCH RMC
Subcarrier spacing	Same as used in PDCCH RMC	Same as used in PDSCH RMC
Aggregation level	Same as used in PDCCH RMC	N/A
Code rate	Same as used in PDCCH RMC	Same as used in PDSCH RMC
Transmit Power	Same as used in PDCCH RMC	Same as used in PDSCH RMC
CP length	Same as used in PDCCH RMC	Same as used in PDSCH RMC
Note 1:	REs not used in the active CORESETs where PDCCH is scheduled for the IAB-MT under test.	
Note 2:	REs not allocated to any physical channels, CORESET, SSB or any other reference signal within the channel bandwidth of the cell.	
Note 3:	No OCNG is transmitted from the probe transmitting non-serving beam.	

## G.1.2.1.3 OCNG pattern 3: Generic OCNG pattern for unused REs in the same bandwidth as PDSCH RMC

**Table G.1.2.1.3-1: OP.3: Generic OCNG pattern for unused REs in the same BW as RMC**

OCNG Parameters	Control Region	Data Region
Resource allocation	Unused REs (Note 1)	Unused REs (Note 2)
Channel	PDCCH	PDSCH
Contents	Virtual IAB-MT IDs	Uncorrelated pseudo random QPSK modulated data
Antenna transmission scheme	Same as used in PDCCH RMC	Same as used in PDSCH RMC
Subcarrier spacing	Same as used in PDCCH RMC	Same as used in PDSCH RMC
Aggregation level	Same as used in PDCCH RMC	N/A
Code rate	Same as used in PDCCH RMC	Same as used in PDSCH RMC
Transmit Power	Same as used in PDCCH RMC	Same as used in PDSCH RMC
CP length	Same as used in PDCCH RMC	Same as used in PDSCH RMC
Note 1:	REs not used in the active CORESETs where PDCCH is scheduled for the IAB-MT under test. REs for OCNG shall not be allocated outside the allocated bandwidth of the PDSCH RMC of the serving cell.	
Note 2:	REs not allocated to any physical channels, CORESET, SSB or any other reference signal within the allocated bandwidth of the PDSCH RMC of the serving cell. REs for OCNG shall not be allocated outside the allocated bandwidth of the PDSCH RMC of the serving cell.	

## G.1.2.1.4 OCNG pattern 4: Generic OCNG pattern for all unused REs outside SSB slot(s)

**Table G.1.2.1.4-1: OP.4: Generic OCNG pattern for all unused REs outside SSB slot(s)**

OCNG Parameters	Control Region	Data Region
Resource allocation	Unused REs (Note 1)	Unused REs (Note 2)
Channel	PDCCH	PDSCH
Contents	Virtual IAB-MT IDs	Uncorrelated pseudo random QPSK modulated data
Antenna transmission scheme	Same as used in PDCCH RMC	Same as used in PDSCH RMC
Subcarrier spacing	Same as used in PDCCH RMC	Same as used in PDSCH RMC
Aggregation level	Same as used in PDCCH RMC	N/A
Code rate	Same as used in PDCCH RMC	Same as used in PDSCH RMC
Transmit Power	Same as used in PDCCH RMC	Same as used in PDSCH RMC
CP length	Same as used in PDCCH RMC	Same as used in PDSCH RMC
Note 1:	REs not used in the active CORESETs where PDCCH is scheduled for the IAB-MT under test. REs for OCNG shall not be allocated in the slot(s) containing SSB of the respective cell.	
Note 2:	REs not allocated to any physical channels, CORESET, SSB or any other reference signal within the channel bandwidth of the cell. REs for OCNG shall not be allocated in the slot(s) containing SSB of the respective cell.	

## G.1.3 Antenna configurations

## G.1.3.1 Antenna configurations for FR1

Unless otherwise specified, NR TDD cells in all RRM Test cases in AWGN propagation condition are configured with Antenna Configuration [1x2].

## G.1.3.1.1 Antenna connection for 4 Rx capable IAB-MT

## G.1.3.1.1.1 Introduction

All tests for FR1 are specified for IAB-MTs supporting 2RX. In this clause, the antenna connection method for applying 2RX tests to IAB-MTs supporting 4RX antenna ports is specified. No tests are currently specified for FR1 which are applicable only to 4RX antenna ports, so 4RX capable IAB-MTs are always tested by reusing tests which were originally specified for 2RX IAB-MTs.

## G.1.3.1.1.2 Principle of testing

## G.1.3.1.1.2.1 Single carrier tests

For 4RX capable IAB-MTs supporting at least one 2RX band, the, all single carrier tests specified for FR1 except those in G.2.3 shall be tested on any band where 2RX is supported with the antenna connection specified in clause G.1.3.1.1.2.2.

For 4RX capable IAB-MT which do not support any 2RX band, all tests specified for FR1 shall be tested using the antenna connection specified in clause G.1.3.1.1.2.3. For radio link monitoring tests, the SNR levels are modified according to table G.1.3.1.1.2.1-1 and table G.1.3.1.1.2.1-2. For beam failure detection and link recovery tests, the SNR levels are modified according to table G.1.3.1.1.2.1-3.

**Table G.1.3.1.1.2.1-1: Modified parameters for RLM out of sync testing with 4 RX antenna connection**

Test case	SNR during T3 (dB)			
	Test 1	Test 2	Test 3	Test 4
G.2.3.1.1	-18	N/A	N/A	N/A
G.2.3.1.3	-18	N/A	N/A	N/A
G.2.3.1.5	-18	N/A	N/A	N/A
G.2.3.1.7	-18	N/A	N/A	N/A

**Table G.1.3.1.1.2.1-2: Modified parameters for RLM in sync single carrier testing with 4 RX antenna connection**

Test case	SNR during T3 (dB)		SNR during T4 (dB)	
	Test 1	Test 2	Test 1	Test 2
G.2.3.1.2	-18	N/A	-8	N/A
G.2.3.1.4	-18	N/A	-8	N/A
G.2.3.1.6	-18	N/A	-8	N/A
G.2.3.1.8	-18	N/A	-8	N/A

**Table G.1.3.1.1.2.1-3: Modified parameters for Beam Failure Detection and Link Recovery testing with 4 RX antenna connection**

Test case	SNR for RS in set $q_0$ during T3, T4 and T5 (dB)
	Test 1
G.2.3.2.1	-15
G.2.3.2.2	-15
G.2.3.2.3	-15
G.2.3.2.4	-15

#### G.1.3.1.1.2.2 Antenna connection for bands where 2RX is supported

For bands where 2RX is supported, it is left to declaration and AP configuration to decide which 2 of the 4 Rx ports are connected with data source from tester. The remaining 2 Rx ports shall be connected with zero input. No test parameters or requirements are modified.

#### G.1.3.1.1.2.3 Antenna connection for bands where 4RX is supported

For bands where 4RX is supported, all 4 RX antennas are connected with data source from tester. The Tester provide independent noise and fading (low correlation) for each antenna port. Except for the modifications to radio link monitoring thresholds described in clauses G.1.3.1.1.2.1 and G.1.3.1.1.2.2, no test parameters or requirements are modified.

### G.1.3.2 Antenna configurations for FR2-1

Unless otherwise specified, the default Downlink Antenna Configuration for NR FR2-1 cells is 1x2.

In case of Downlink Antenna Configuration 2x2 for NR FR2-1 cells, unless otherwise specified, the downlink signal is transmitted over the two polarizations (V and H) of the dual polarized antenna of the test equipment.

## G.1.4 BWP configurations

### G.1.4.1 Introduction

This clause provides the typical BWP configurations used for RRM test cases defined in Annex G. For downlink BWP, both initial BWP and dedicated BWP configurations are specified in clause G.1.4.2 and for uplink BWP, both initial BWP and dedicated BWP configurations are specified in clause G.1.4.3.



G.1.4.2 Downlink BWP configurations

G.1.4.2.1 Initial BWP

**Table G.1.4.2.1-1: Downlink BWP patterns for initial BWP configuration**

BWP Parameters	Unit	Values		
Reference BWP		DLBWP.0.1	DLBWP.0.2	
Starting PRB index		0	RB <sub>a</sub> <sup>Note 1</sup>	
Bandwidth	RB	Same as RF channel defined in each test	same as RMSI CORESET (CORESET #0) defined in each test	
Note 1: RB <sub>a</sub> is the lowest PRB index to guarantee the BWP including SSB PRB index (RB <sub>J</sub> , RB <sub>J+1</sub> ,..., RB <sub>J+19</sub> ) which is defined in Clause G.1.5.				

G.1.4.2.2 Dedicated BWP

**Table G.1.4.2.2-1: Downlink BWP patterns for dedicated BWP configuration**

BWP Parameters	Unit	Values		
Reference BWP		DLBWP.1.1	DLBWP.1.2	DLBWP.1.3
Starting PRB index		0	RB <sub>b</sub> <sup>Note 1</sup>	RB <sub>a</sub> <sup>Note 2</sup>
Bandwidth	RB	Same as RF channel defined in each test	25 for SCS = 15KHz, 51 for SCS = 30KHz, 32 for SCS = 120KHz	25 for SCS = 15KHz, 51 for SCS = 30KHz, 32 for SCS = 120KHz
Note 1: RB <sub>b</sub> is the lowest PRB index to guarantee the BWP not fully overlapped with SSB PRB index (RB <sub>J</sub> , RB <sub>J+1</sub> ,..., RB <sub>J+19</sub> ) which is defined in Clause G.1.5.				
Note 2: RB <sub>a</sub> is the lowest PRB index to guarantee the BWP including SSB PRB index (RB <sub>J</sub> , RB <sub>J+1</sub> ,..., RB <sub>J+19</sub> ) which is defined in Clause G.1.5.				

G.1.4.3 Uplink BWP configurations

G.1.4.3.1 Initial BWP

**Table G.1.4.3.1-1: Uplink BWP patterns for initial BWP configuration**

BWP Parameters	Unit	Values		
Reference BWP		ULBWP.0.1	ULBWP.0.2	
Starting PRB index		0	RB <sub>a</sub> <sup>Note 1</sup>	
Bandwidth	RB	Same as RF channel defined in each test	same as RMSI CORESET (CORESET #0) defined in each test	
Note 1: RB <sub>a</sub> is same as RB <sub>a</sub> for DLBWP.0.2 as defined in Table G.1.4.2.1-1.				

## G.1.4.3.2 Dedicated BWP

**Table G.1.4.3.2-1: Uplink BWP patterns for dedicated BWP configuration**

BWP Parameters	Unit	Values		
		ULBWP.1.1	ULBWP.1.2	ULBWP.1.3
Reference BWP		0	$RB_b$ <sup>Note 1</sup>	$RB_a$ <sup>Note 2</sup>
Starting PRB index		0	$RB_b$ <sup>Note 1</sup>	$RB_a$ <sup>Note 2</sup>
Bandwidth	RB	Same as RF channel defined in each test	25 for SCS = 15KHz, 51 for SCS = 30KHz, 32 for SCS = 120KHz	25 for SCS = 15KHz, 51 for SCS = 30KHz, 32 for SCS = 120KHz
Note 1: $RB_b$ is same as $RB_b$ for DLBWP.1.2 as defined in Table G.1.4.2.2-1.				
Note 2: $RB_a$ is same as $RB_a$ for DLBWP.1.3 as defined in Table G.1.4.2.2-1.				

## G.1.5 SSB Configurations

## G.1.5.1 SSB Configurations for FR1

## G.1.5.1.1 SSB pattern 1 in FR1: SSB allocation for SSB SCS=15 kHz

**Table G.1.5.1.1-1: SSB.1 FR1: SSB Pattern 1 for SSB SCS=15 kHz in 10 MHz channel**

SSB Parameters	Values
SSB SCS	15 kHz
SSB periodicity ( $T_{SSB}$ )	20 ms
Number of SSBs per SS-burst	1
SS/PBCH block index	0
Symbol numbers containing SSB <sup>Note 2</sup>	2-5
Slot numbers containing SSB <sup>Note 2</sup>	0
SFN containing SSB	SFN mod ( $\max(T_{SSB}, 10\text{ms})/10\text{ms}$ ) = 0
RB numbers containing SSB within channel BW	( $RB_J, RB_{J+1}, \dots, RB_{J+19}$ ) <sup>Note 1</sup>
Note 1: RBs containing SSB can be configured in any frequency location within the cell bandwidth according to the allowed synchronization raster defined in clause 5.4.3	
Note 2: These values have been derived from other parameters for information purposes (as per TS 38.213 [3]). They are not settable parameters themselves.	

## G.1.5.1.2 SSB pattern 2 in FR1: SSB allocation for SSB SCS=30 kHz

Table G.1.5.1.2-1: SSB.2 FR1: SSB Pattern 2 for SSB SCS=30 kHz

SSB Parameters	Values
SSB SCS	30 kHz
SSB periodicity ( $T_{SSB}$ )	20 ms
Number of SSBs per SS-burst	1
SS/PBCH block index	0
Symbol numbers containing SSB <sup>Note 3</sup>	4-7 or 2-5 <sup>Note 2</sup>
Slot numbers containing SSB <sup>Note 3</sup>	0
SFN containing SSB	SFN mod ( $\max(T_{SSB}, 10\text{ms})/10\text{ms}$ ) = 0
RB numbers containing SSB within channel BW	( $RB_J, RB_{J+1}, \dots, RB_{J+19}$ ) <sup>Note 1</sup>
Note 1: RBs containing SSB can be configured in any frequency location within the cell bandwidth according to the allowed synchronization raster defined in clause 5.4.3	
Note 2: Symbols 4-7 is chosen, if the SSB pattern Case B should be used for the current band as define in clause 5.4.3]; Otherwise, symbol 2-5 is chosen.	
Note 3: These values have been derived from other parameters for information purposes (as per TS 38.213 [3]). They are not settable parameters themselves	

## G.1.5.1.3 SSB pattern 3 in FR1: SSB allocation for SSB SCS=15 kHz

Table G.1.5.1.3-1: SSB.3 FR1: SSB Pattern 3 for SSB SCS=15 kHz

SSB Parameters	Values	
SSB SCS	15 kHz	
SSB periodicity ( $T_{SSB}$ )	20 ms	
Number of SSBs per SS-burst	2	
SS/PBCH block index	0	1
Symbol numbers containing SSB <sup>Note 2</sup>	2-5	8-11
Slot numbers containing SSB <sup>Note 2</sup>	0	0
SFN containing SSB	SFN mod ( $\max(T_{SSB}, 10\text{ms})/10\text{ms}$ ) = 0	
RB numbers containing SSB within channel BW	( $RB_J, RB_{J+1}, \dots, RB_{J+19}$ ) <sup>Note 1</sup>	
Note 1: RBs containing SSB can be configured in any frequency location within the cell bandwidth according to the allowed synchronization raster defined in clause 5.4.3		
Note 2: These values have been derived from other parameters for information purposes (as per TS 38.213 [3]). They are not settable parameters themselves.		

## G.1.5.1.4 SSB pattern 4 in FR1: SSB allocation for SSB SCS=30 kHz

**Table G.1.5.1.4-1: SSB.4 FR1: SSB Pattern 4 for SSB SCS=30 kHz**

SSB Parameters	Values	
SSB SCS	30 kHz	
SSB periodicity ( $T_{SSB}$ )	20 ms	
Number of SSBs per SS-burst	2	
SS/PBCH block index	0	1
Symbol numbers containing SSB <sup>Note 3</sup>	4-7 or 2-5 <sup>Note 2</sup>	8-11
Slot numbers containing SSB <sup>Note 3</sup>	0	0
SFN containing SSB	SFN mod ( $\max(T_{SSB}, 10\text{ms})/10\text{ms}$ ) = 0	
RB numbers containing SSB within channel BW	$(RB_J, RB_{J+1}, \dots, RB_{J+19})^{\text{Note 1}}$	
Note 1:	RBs containing SSB can be configured in any frequency location within the cell bandwidth according to the allowed synchronization raster defined in clause 5.4.3.	
Note 2:	Symbols 4-7 is chosen, if the SSB pattern Case B should be used for the current band as defined in clause 5.4.3; Otherwise, symbol 2-5 is chosen.	
Note 3:	These values have been derived from other parameters for information purposes (as per TS 38.213 [3]). They are not settable parameters themselves.	

## G.1.5.1.5 SSB pattern 5 in FR1: SSB allocation for SSB SCS=15 kHz starting from odd SFN

**Table G.1.5.1.5-1: SSB.5 FR1: SSB Pattern 5 for SSB SCS=15 kHz**

SSB Parameters	Values
SSB SCS	15 kHz
SSB periodicity ( $T_{SSB}$ )	20 ms
Number of SSBs per SS-burst	1
SS/PBCH block index	0
Symbol numbers containing SSB <sup>Note 2</sup>	2-5
Slot numbers containing SSB <sup>Note 2</sup>	0
SFN containing SSB	SFN mod ( $\max(T_{SSB}, 10\text{ms})/10\text{ms}$ ) = 1
RB numbers containing SSB within channel BW	$(RB_J, RB_{J+1}, \dots, RB_{J+19})^{\text{Note 1}}$
Note 1:	RBs containing SSB can be configured in any frequency location within the cell bandwidth according to the allowed synchronization raster defined in clause 5.4.3.
Note 2:	These values have been derived from other parameters for information purposes (as per TS 38.213 [3]). They are not settable parameters themselves.

G.1.5.1.6 SSB pattern 6 in FR1: SSB allocation for SSB SCS=30 kHz starting from odd SFN

**Table G.1.5.1.6-1: SSB.6 FR1: SSB Pattern 6 for SSB SCS=30 kHz**

SSB Parameters	Values
SSB SCS	30 kHz
SSB periodicity ( $T_{SSB}$ )	20 ms
Number of SSBs per SS-burst	1
SS/PBCH block index	0
Symbol numbers containing SSB <sup>Note 3</sup>	4-7 or 2-5 <sup>Note 2</sup>
Slot numbers containing SSB <sup>Note 3</sup>	0
SFN containing SSB	SFN mod $(\max(T_{SSB}, 10\text{ms})/10\text{ms}) = 1$
RB numbers containing SSB within channel BW	$(RB_J, RB_{J+1}, \dots, RB_{J+19})$ <sup>Note 1</sup>
Note 1:	RBs containing SSB can be configured in any frequency location within the cell bandwidth according to the allowed synchronization raster defined in clause 5.4.3
Note 2:	Symbols 4-7 is chosen, if the SSB pattern Case B should be used for the current band as defined in clause 5.4.3; Otherwise, symbol 2-5 is chosen.
Note 3:	These values have been derived from other parameters for information purposes (as per TS 38.213 [3]). They are not settable parameters themselves.

G.1.5.2 SSB Configurations for FR2-1

G.1.5.2.1 SSB pattern 1 in FR2-1: SSB allocation for SSB SCS=120 kHz

**Table G.1.5.2.1-1: SSB.1 FR2-1: SSB Pattern 1 for SSB SCS = 120 kHz with 2 SSBs per SS-burst**

SSB Parameters	Values
SSB SCS	120 kHz
SSB periodicity ( $T_{SSB}$ )	20 ms
Number of SSBs per SS-burst	2
SS/PBCH block index	0      1
Symbol numbers containing SSBs <sup>Note 2</sup>	4-7      8-11
Slot numbers containing SSB <sup>Note 2</sup>	0      0
SFN containing SSB	SFN mod $(\max(T_{SSB}, 10\text{ms})/10\text{ms}) = 0$
RB numbers containing SSBs within channel BW	$(RB_J, RB_{J+1}, \dots, RB_{J+19})$ <sup>Note 1</sup>
Note 1:	RBs containing SSB can be configured in any frequency location within the cell bandwidth according to the allowed synchronization raster defined in clause 5.4.3.
Note 2:	These values have been derived from other parameters for information purposes (as per TS 38.213 [3]). They are not settable parameters themselves.

G.1.5.2.2 SSB pattern 2 in FR2-1: SSB allocation for SSB SCS=240 kHz

**Table G.1.5.2.2-1: SSB.2 FR2-1: SSB Pattern 2 for SSB SCS = 240 kHz with 2 SSBs per SS-burst**

SSB Parameters	Values
SSB SCS	240 kHz
SSB periodicity ( $T_{SSB}$ )	20 ms
Number of SSBs per SS-burst	2
SS/PBCH block index	0      1
Symbol numbers containing SSBs <sup>Note 2</sup>	8-11      12-13, 0-1
Slot numbers containing SSB <sup>Note 2</sup>	0      0, 1
SFN containing SSB	SFN mod $(\max(T_{SSB}, 10\text{ms})/10\text{ms}) = 0$
RB numbers containing SSBs within channel BW	$(RB_J, RB_{J+1}, \dots, RB_{J+39})$ <sup>Note 1</sup>
Note 1:	RBs containing SSB can be configured in any frequency location within the cell bandwidth according to the allowed synchronization raster defined in clause 5.4.3.
Note 2:	These values have been derived from other parameters for information purposes (as per TS 38.213 [3]). They are not settable parameters themselves.

## G.1.5.2.3 SSB pattern 3 in FR2-1: SSB allocation for SSB SCS=120 kHz

**Table G.1.5.2.3-1: SSB.3 FR2-1: SSB Pattern 3 for SSB SCS = 120 kHz with 1 SSB per SS-burst**

SSB Parameters	Values
SSB SCS	120 kHz
SSB periodicity ( $T_{SSB}$ )	20 ms
Number of SSBs per SS-burst	1
SS/PBCH block index	0
Symbol numbers containing SSBs <sup>Note 2</sup>	4-7
Slot numbers containing SSB <sup>Note 2</sup>	0
SFN containing SSB	SFN mod ( $\max(T_{SSB}, 10\text{ms})/10\text{ms}$ ) = 0
RB numbers containing SSBs within channel BW	( $RB_J, RB_{J+1}, \dots, RB_{J+19}$ ) <sup>Note 1</sup>
Note 1: RBs containing SSB can be configured in any frequency location within the cell bandwidth according to the allowed synchronization raster defined in clause 5.4.3.	
Note 2: These values have been derived from other parameters for information purposes (as per TS 38.213 [3]). They are not settable parameters themselves.	

## G.1.5.2.4 SSB pattern 4 in FR2-1: SSB allocation for SSB SCS=240 kHz

**Table G.1.5.2.4-1: SSB.4 FR2-1: SSB Pattern 4 for SSB SCS = 240 kHz with 1 SSB per SS-burst**

SSB Parameters	Values
SSB SCS	240 kHz
SSB periodicity ( $T_{SSB}$ )	20 ms
Number of SSBs per SS-burst	1
SS/PBCH block index	0
Symbol numbers containing SSBs <sup>Note 2</sup>	8-11
Slot numbers containing SSB <sup>Note 2</sup>	0
SFN containing SSB	SFN mod ( $\max(T_{SSB}, 10\text{ms})/10\text{ms}$ ) = 0
RB numbers containing SSBs within channel BW	( $RB_J, RB_{J+1}, \dots, RB_{J+39}$ ) <sup>Note 1</sup>
Note 1: RBs containing SSB can be configured in any frequency location within the cell bandwidth according to the allowed synchronization raster defined in clause 5.4.3.	
Note 2: These values have been derived from other parameters for information purposes (as per TS 38.213 [3]). They are not settable parameters themselves.	

## G.1.5.2.5 SSB pattern 5 in FR2-1: SSB allocation for SSB SCS=120 kHz

**Table G.1.5.2.5-1: SSB.5 FR2-1: SSB Pattern 5 for SSB SCS = 120 kHz with 2 SSBs per SS-burst**

SSB Parameters	Values	
SSB SCS	120 kHz	
SSB periodicity ( $T_{SSB}$ )	20 ms	
Number of SSBs per SS-burst	2	
SS/PBCH block index	2	3
Symbol numbers containing SSBs <sup>Note 2</sup>	2-5	6-9
Slot numbers containing SSB <sup>Note 2</sup>	1	1
SFN containing SSB	SFN mod ( $\max(T_{SSB}, 10\text{ms})/10\text{ms}$ ) = 0	
RB numbers containing SSBs within channel BW	( $RB_J, RB_{J+1}, \dots, RB_{J+19}$ ) <sup>Note 1</sup>	
Note 1: RBs containing SSB can be configured in any frequency location within the cell bandwidth according to the allowed synchronization raster defined in clause 5.4.3.		
Note 2: These values have been derived from other parameters for information purposes (as per TS 38.213 [3]). They are not settable parameters themselves.		

## G.1.5.2.6 SSB pattern 6 in FR2-1: SSB allocation for SSB SCS=240 kHz

**Table G.1.5.2.6-1: SSB.6 FR2-1: SSB Pattern 6 for SSB SCS = 240 kHz with 2 SSBs per SS-burst**

SSB Parameters	Values	
SSB SCS	240 kHz	
SSB periodicity ( $T_{SSB}$ )	20 ms	
Number of SSBs per SS-burst	2	
SS/PBCH block index	2	3
Symbol numbers containing SSBs <sup>Note 2</sup>	2-5	6-9
Slot numbers containing SSB <sup>Note 2</sup>	1	1
SFN containing SSB	SFN mod ( $\max(T_{SSB}, 10\text{ms})/10\text{ms}$ ) = 0	
RB numbers containing SSBs within channel BW	$(RB_J, RB_{J+1}, \dots, RB_{J+39})^{\text{Note 1}}$	
Note 1: RBs containing SSB can be configured in any frequency location within the cell bandwidth according to the allowed synchronization raster defined in clause 5.4.3.		
Note 2: These values have been derived from other parameters for information purposes (as per TS 38.213 [3]). They are not settable parameters themselves.		

## G.1.5.2.7 SSB pattern 7 in FR2-1: SSB allocation for SSB SCS=120 kHz

**Table G.1.5.2.7-1: SSB.7 FR2-1: SSB Pattern 7 for SSB SCS = 120 kHz with 1 SSB per SS-burst**

SSB Parameters	Values	
SSB SCS	120 kHz	
SSB periodicity ( $T_{SSB}$ )	20 ms	
Number of SSBs per SS-burst	1	
SS/PBCH block index	1	
Symbol numbers containing SSBs <sup>Note 2</sup>	8-11	
Slot numbers containing SSB <sup>Note 2</sup>	0	
SFN containing SSB	SFN mod ( $\max(T_{SSB}, 10\text{ms})/10\text{ms}$ ) = 0	
RB numbers containing SSBs within channel BW	$(RB_J, RB_{J+1}, \dots, RB_{J+19})^{\text{Note 1}}$	
Note 1: RBs containing SSB can be configured in any frequency location within the cell bandwidth according to the allowed synchronization raster defined in clause 5.4.3.		
Note 2: These values have been derived from other parameters for information purposes (as per TS 38.213 [3]). They are not settable parameters themselves.		

## G.1.5.2.8 SSB pattern 8 in FR2-1: SSB allocation for SSB SCS=240 kHz

**Table G.1.5.2.8-1: SSB.8 FR2-1: SSB Pattern 8 for SSB SCS = 240 kHz with 1 SSB per SS-burst**

SSB Parameters	Values	
SSB SCS	240 kHz	
SSB periodicity ( $T_{SSB}$ )	20 ms	
Number of SSBs per SS-burst	1	
SS/PBCH block index	1	
Symbol numbers containing SSBs <sup>Note 2</sup>	12-13	0-1
Slot numbers containing SSB <sup>Note 2</sup>	0	1
SFN containing SSB	SFN mod ( $\max(T_{SSB}, 10\text{ms})/10\text{ms}$ ) = 0	
RB numbers containing SSBs within channel BW	$(RB_J, RB_{J+1}, \dots, RB_{J+39})^{\text{Note 1}}$	
Note 1: RBs containing SSB can be configured in any frequency location within the cell bandwidth according to the allowed synchronization raster defined in clause 5.4.3.		
Note 2: These values have been derived from other parameters for information purposes (as per TS 38.213 [3]). They are not settable parameters themselves.		

## G.1.6 SMTC Configurations

### G.1.6.1 SMTC pattern 1: SMTC period = 20 ms with SMTC duration = 1 ms

**Table G.1.6.1-1: SMTC.1: SMTC Pattern 1 for SMTC period = 20 ms and duration = 1 ms**

SMTC Parameters	Values
SMTC periodicity	20 ms
SMTC offset	0 ms
SMTC duration	1 ms

### G.1.6.2 SMTC pattern 2: SMTC period = 20 ms with SMTC duration = 5 ms

**Table G.1.6.2-1: SMTC.2: SMTC Pattern 2 for SMTC period = 20 ms and duration = 5 ms**

SMTC Parameters	Values
SMTC periodicity	20 ms
SMTC offset	0 ms
SMTC duration	5 ms

### G.1.6.3 SMTC pattern 3: SMTC period = 160 ms with SMTC duration = 1 ms

**Table G.1.6.3-1: SMTC.3: SMTC Pattern 3 for SMTC period = 20 ms and duration = 5 ms**

SMTC Parameters	Values
SMTC periodicity	160 ms
SMTC offset	0 ms
SMTC duration	1 ms

### G.1.6.4 SMTC pattern 4: SMTC period = 20 ms with SMTC duration = 1 ms

**Table G.1.6.4-1: SMTC.4: SMTC Pattern 4 for SMTC period = 20 ms and duration = 1 ms**

SMTC Parameters	Values
SMTC periodicity	20 ms
SMTC offset	10 ms
SMTC duration	1 ms

### G.1.6.5 SMTC pattern 5: SMTC period = 20 ms with SMTC duration = 5 ms

**Table G.1.6.4-1: SMTC.5: SMTC Pattern 5 for SMTC period = 20 ms and duration = 5 ms**

SMTC Parameters	Values
SMTC periodicity	20 ms
SMTC offset	10 ms
SMTC duration	5 ms



## G.1.7 CSI-RS configurations

### G.1.7.1 TDD

**Table G.1.7.1-1: CSI-RS Reference Measurement Channels for SCS=15kHz**

Resource Type	CSI-RS.1.1 TDD	CSI-RS.1.2 TDD	CSI-RS.1.3 TDD	CSI-RS.1.4 TDD
Resource Type	periodic	periodic	aperiodic	aperiodic
<b>Resource Set Config</b>				
nzp-CSI-ResourceSetId	0	0	0	0
repetition	n.a.	off	off	on
aperiodicTriggeringOffset	n.a.	n.a.	0	0
trs-Info	n.a.	n.a.	n.a.	n.a.
<b>Resource Config</b>				
nzp-CSI-RS-ResourceId	0 for resource #0	10 for resource #0	20 for resource #0	0 for resource #0
				1 for resource #1
				2 for resource #2
				3 for resource #3
		11 for resource #1	21 for resource #1	4 for resource #4
				5 for resource #5
				6 for resource #6
			7 for resource #7	
powerControlOffset	0	0	0	0
powerControlOffsetSS	db0	db0	db0	db0
scramblingID	0	0	0	0
Period (slots)	slot5	slot10	n.a.	n.a.
qcl-InfoPeriodicCSI-RS	TCI.State.0	TCI.State.0	n.a.	n.a.
		TCI.State.1		
frequencyDomainAllocation	000001	000001	000001	000001
nrofPorts	2	1	1	1
firstOFDMsymbolInTimeDomain	4 for resource #0	6 for resource #0	6 for resource #0	0 for resource #0
				1 for resource #1
				2 for resource #2
				3 for resource #3
		10 for resource #1	10 for resource #1	4 for resource #4
				5 for resource #5
				6 for resource #6
			7 for resource #7	
cdm-Type	FD-CDM2	noCDM	noCDM	noCDM
density	1	3	3	3
startingRB	0	0	0	0
nrofRBs	276 (Note 1)	276 (Note 1)	276 (Note 1)	276 (Note 1)
Note 1:	If the configured value of PRBs is larger than the width of the corresponding BWP relevant for the test case, the Test Equipment shall implement CSI-RS only in the width of that BWP.			

Table G.1.7.1-2: CSI-RS Reference Measurement Channels for SCS=30kHz

Resource Type	CSI-RS.2.1 TDD	CSI-RS.2.2 TDD	CSI-RS.2.3 TDD	CSI-RS.2.4 TDD
<b>Resource Set Config</b>	periodic	periodic	aperiodic	aperiodic
nzp-CSI-ResourceSetId	0	0	0	0
repetition	n.a.	off	off	on
aperiodicTriggeringOffset	n.a.	n.a.	0	0
trs-Info	n.a.	n.a.	n.a.	n.a.
<b>Resource Config</b>				
nzp-CSI-RS-ResourceId	0 for resource #0	10 for resource #0	20 for resource #0	0 for resource #0
				1 for resource #1
				2 for resource #2
				3 for resource #3
		11 for resource #1	21 for resource #1	4 for resource #4
				5 for resource #5
				6 for resource #6
			7 for resource #7	
powerControlOffset	0	0	0	0
powerControlOffsetSS	db0	db0	db0	db0
scramblingID	0	0	0	0
Period (slots)	slot10	slot20	n.a.	n.a.
qcl-InfoPeriodicCSI-RS	TCI.State.0	TCI.State.0	n.a.	n.a.
		TCI.State.1		
frequencyDomainAllocation	000001	000001	000001	000001
nrofPorts	2	1	1	1
firstOFDMSymbolInTimeDomain	4 for resource #0	6 for resource #0	6 for resource #0	0 for resource #0
				1 for resource #1
				2 for resource #2
				3 for resource #3
		10 for resource #1	10 for resource #1	4 for resource #4
				5 for resource #5
				6 for resource #6
			7 for resource #7	
cdm-Type	FD-CDM2	noCDM	noCDM	noCDM
density	1	3	3	3
startingRB	0	0	0	0
nrofRBs	276 (Note 1)	276 (Note 1)	276 (Note 1)	276 (Note 1)
Note 1: If the configured value of PRBs is larger than the width of the corresponding BWP relevant for the test case, the Test Equipment shall implement CSI-RS only in the width of that BWP.				

Table G.1.7.1-3: CSI-RS Reference Measurement Channels for SCS=120kHz

Resource Type	CSI-RS.3.1 TDD	CSI-RS.3.2 TDD	CSI-RS.3.3 TDD	CSI-RS.3.4 TDD
<b>Resource Set Config</b>	periodic	periodic	aperiodic	aperiodic
nzp-CSI-ResourceSetId	0	0	0	0
repetition	n.a.	off	off	on
aperiodicTriggeringOffset	n.a.	n.a.	4	4
trs-Info	n.a.	n.a.	n.a.	n.a.
<b>Resource Config</b>				
nzp-CSI-RS-ResourceId	0 for resource #0	10 for resource #0	20 for resource #0	0 for resource #0
				1 for resource #1
				2 for resource #2
				3 for resource #3
		11 for resource #1	21 for resource #1	4 for resource #4
				5 for resource #5
				6 for resource #6
			7 for resource #7	
powerControlOffset	0	0	0	0
powerControlOffsetSS	db0	db0	db0	db0
scramblingID	0	0	0	0
Period (slots)	slot40	slot80	n.a.	n.a.
qcl-InfoPeriodicCSI-RS	TCI.State.0	TCI.State.0	n.a.	n.a.
		TCI.State.1		
frequencyDomainAllocation	000001	000001	000001	000001
nrofPorts	1	1	1	1
firstOFDMsymbolInTimeDomain	4 for resource #0	6 for resource #0	6 for resource #0	0 for resource #0
				1 for resource #1
				2 for resource #2
				3 for resource #3
		10 for resource #1	10 for resource #1	4 for resource #4
				5 for resource #5
				6 for resource #6
			7 for resource #7	
cdm-Type	FD-CDM2	noCDM	noCDM	noCDM
density	1	3	3	3
startingRB	0	0	0	0
nrofRBs	276 (Note 1)	276 (Note 1)	276 (Note 1)	276 (Note 1)
Note 1:	If the configured value of PRBs is larger than the width of the corresponding BWP relevant for the test case, the Test Equipment shall implement CSI-RS only in the width of that BWP.			

## G.1.8 Angle of Arrival (AoA) for FR2-1 RRM test cases

This clause specifies the AoA setups for FR2-1 RRM test cases. The applicable AoA setup is defined in each test case.

### G.1.8.1 Setup 1: Single AoA

There is only one active probe in the test. The DL signals, and noise if applicable, transmitted from the probe, are aligned to AoA based upon the declaration.

### G.1.8.2 Setup 2: 2 AoAs

There are 2 active probes in the test. The DL signals, and noise if applicable, transmitted from the two active probes, align to AoAs based upon the declaration.

## G.1.9 TCI State Configuration

### G.1.9.1 Introduction

This clause provides the configurations for TCI states towards either SSB or CSI-RS. The TCI states defined in this clause are configured in each test when applicable to indicate that certain DL signals are QCL'ed with the referenceSignal configured in the TCI states.

### G.1.9.2 TCI states

**Table G.1.9.2-1: TCI States**

Parameter	TCI.State.0	TCI.State.1	TCI.State.2	TCI.State.3
tci-StateId	Id0	Id1	Id2	Id3
qcl-Type1	typeC	typeC	typeA	typeA
qcl-Type2 <sup>Note1</sup>	typeD	typeD	typeD	typeD
referenceSignal	SSB0	SSB1	Resource #4 in TRS resource set 1 <sup>Note3</sup>	Resource #4 in TRS resource set 2 <sup>Note3</sup>
Note 1: qcl-Type2 of typeD only where applicable. For RRM test cases, this will be only in FR2-1 Note 2: referenceSignal configurations towards which the TCI states are configured are defined in a test-specific manner. Note 3: Reference TRS resource sets are defined in G.1.10, and the applicable TRS resource set(s) are specified in each test case. When a single TRS resource set is configured in a test case, it is considered as resource set 1.				

## G.1.10 Configurations of CSI-RS for tracking

### G.1.10.1 Configuration of CSI-RS for tracking for FR1

#### G.1.10.1.2 TDD

**Table G.1.10.1.2-1: CSI-RS for tracking for SCS=15kHz**

Parameter	Unit	Value
Reference channel		TRS.1.1 TDD
Bandwidth		BW of Active BWP <sup>Note 1</sup>
SCS	kHz	15
First subcarrier index in the PRB used for CSI-RS		$k_0=0$ for CSI-RS resource 1,2,3,4
First OFDM symbol in the slot used for CSI-RS		$l_0 = 5$ for CSI-RS resource 1 and 3 $l_0 = 9$ for CSI-RS resource 2 and 4
Number of CSI-RS ports (X)		1 for CSI-RS resource 1,2,3,4
CDM Type		'No CDM' for CSI-RS resource 1,2,3,4
Density ( $\rho$ )		3 for CSI-RS resource 1,2,3,4
CSI-RS periodicity	slots	20 for CSI-RS resource 1,2,3,4
EPRE ratio to SSS	dB	-3 <sup>Note 2</sup>
TCI state		TCI.State.0
Note: BW of TRS is configured same as the BW size of IAB-MT active BWP in the RRM test cases		

**Table G.1.10.1.2-2: CSI-RS for tracking for SCS=30kHz**

Parameter	Unit	Value
Reference channel		TRS.1.2 TDD
Bandwidth		BW of Active BWP <sup>Note 1</sup>
SCS	kHz	30
First subcarrier index in the PRB used for CSI-RS		$k_0=0$ for CSI-RS resource 1,2,3,4
First OFDM symbol in the slot used for CSI-RS		$l_0 = 5$ for CSI-RS resource 1 and 3 $l_0 = 9$ for CSI-RS resource 2 and 4
Number of CSI-RS ports (X)		1 for CSI-RS resource 1,2,3,4
CDM Type		'No CDM' for CSI-RS resource 1,2,3,4
Density ( $\rho$ )		3 for CSI-RS resource 1,2,3,4
CSI-RS periodicity	slots	40 for CSI-RS resource 1,2,3,4
EPRE ratio to SSS	dB	-3 <sup>Note 2</sup>
TCI state		TCI.State.0
Note 1: BW of TRS is configured same as the BW size of IAB-MT active BWP in the RRM test cases		
Note 2: Unless otherwise specified in the test case		

## G.1.10.2 Configuration of CSI-RS for tracking for FR2-1

### G.1.10.2.1 TDD

**Table G.1.10.2.1-1: CSI-RS for tracking for SCS=120kHz Set 1**

Parameter	Unit	Value
Reference channel		TRS.2.1 TDD
Bandwidth		BW of Active BWP <sup>Note 1,3</sup>
SCS	kHz	120
First subcarrier index in the PRB used for CSI-RS		$k_0=0$ for CSI-RS resource 1,2,3,4
First OFDM symbol in the slot used for CSI-RS		$l_0 = 1$ for CSI-RS resource 1 and 3 $l_0 = 5$ for CSI-RS resource 2 and 4
Number of CSI-RS ports (X)		1 for CSI-RS resource 1,2,3,4
CDM Type		'No CDM' for CSI-RS resource 1,2,3,4
Density ( $\rho$ )		3 for CSI-RS resource 1,2,3,4
CSI-RS periodicity	slots	80 for CSI-RS resource 1,2,3,4
EPRE ratio to SSS	dB	-3 <sup>Note 2</sup>
TCI state		TCI.State.0
Note 1: BW of TRS is configured same as the BW size of IAB-MT active BWP in the RRM test cases		
Note 2: Unless otherwise specified in the test case		
Note 3: If active BWP is larger than 52RBs, BW of TRS is configured as 52RBs. Otherwise, same as active BWP size.		

**Table G.1.10.2.1-2: CSI-RS for tracking for SCS=120kHz Set 2**

Parameter	Unit	Value
Reference channel		TRS.2.2 TDD
Bandwidth		BW of Active BWP <sup>Note 1,3</sup>
SCS	kHz	120
First subcarrier index in the PRB used for CSI-RS		$k_0=0$ for CSI-RS resource 1,2,3,4
First OFDM symbol in the slot used for CSI-RS		$l_0 = 2$ for CSI-RS resource 1 and 3 $l_0 = 6$ for CSI-RS resource 2 and 4
Number of CSI-RS ports (X)		1 for CSI-RS resource 1,2,3,4
CDM Type		'No CDM' for CSI-RS resource 1,2,3,4
Density ( $\rho$ )		3 for CSI-RS resource 1,2,3,4
CSI-RS periodicity	slots	80 for CSI-RS resource 1,2,3,4
EPRE ratio to SSS	dB	-3 <sup>Note 2</sup>
TCI state		TCI.State.1
Note 1: BW of TRS is configured same as the BW size of IAB-MT active BWP in the RRM test cases		
Note 2: Unless otherwise specified in the test case		
Note 3: If active BWP is larger than 52RBs, BW of TRS is configured as 52RBs. Otherwise, same as active BWP size.		

## G.2 IAB-MT RRM test cases

### G.2.1 RRC\_CONNECTED state mobility for IAB-MTs

#### G.2.1.1 RRC Connection Mobility Control

##### G.2.1.1.1 RRC Re-establishment

##### G.2.1.1.1.1 Inter-frequency RRC Re-establishment in FR1 for LA IAB-MT

##### G.2.1.1.1.1.1 Test Purpose and Environment

The purpose is to verify that the NR inter-frequency RRC re-establishment delay in FR1 to an unknown target cell is within the specified limits. These tests will verify the requirements in clause 12.1.1.1. This test case is applicable only for local area IAB-MT and for IAB type 1-H.

The test parameters are given in table G.2.1.1.1.1.1-1, table G.2.1.1.1.1.1-2 and table G.2.1.1.1.1.1-3 below. The test consists of 3 successive time periods, with time duration of T1, T2 and T3 respectively. At the start of time period T2, cell 1, which is the active cell, becomes inactive. The time period T3 starts after the occurrence of the radio link failure. During T1, the IAB-MT shall be configured with the carrier frequency of cell 2 (with RF Channel Number #2) to ensure that the IAB-MT has the context of the carrier frequency of cell 2 by the end of T1.

**Table G.2.1.1.1.1.1-1: Supported test configurations**

Configuration	Description of serving cell	Description of target cell
1	15 kHz SSB SCS, 10 MHz bandwidth, TDD duplex mode	15 kHz SSB SCS, 10 MHz bandwidth, TDD duplex mode
2	30 kHz SSB SCS, 40 MHz bandwidth, TDD duplex mode	30 kHz SSB SCS, 40 MHz bandwidth, TDD duplex mode
Note: The IAB-MT is only required to be tested in one of the supported test configurations.		

**Table G.2.1.1.1.1-2: General test parameters for NR inter-frequency RRC Re-establishment test case in FR1**

Parameter		Unit	Test configuration	Value	Comment
Initial condition	Active cell		1, 2	Cell1	
	Neighbour cells		1, 2	Cell2	
Final condition	Active cell		1, 2	Cell2	
RF Channel Number			1, 2	1, 2	
Time offset between cells			1, 2	3 $\mu$ s	Synchronous cells
N310		-	1, 2	1	Maximum consecutive out-of-sync indications from lower layers
N311		-	1, 2	1	Minimum consecutive in-sync indications from lower layers
T310		ms	1, 2	0	Radio link failure timer; T310 is disabled
T311		ms	1, 2	30000	RRC re-establishment timer
Access Barring Information		-	1, 2	Not Sent	No additional delays in random access procedure.
SSB configuration			1	SSB.1 FR1	
			2	SSB.2 FR1	
SMTC configuration			1	SMTC pattern 1	
			2	SMTC pattern 1	
DRX cycle length		s	1, 2	OFF	
PRACH configuration			1, 2	FR1 PRACH configuration 1	TBD
T1		s	1, 2	20	
T2		ms	1, 2	1000	Time for the IAB-MT to detect RLF
T3		s	1, 2	20	

**Table G.2.1.1.1.1-3: Cell specific test parameters for NR inter-frequency RRC Re-establishment test case in FR1**

Parameter	Unit	Test configuration	Cell 1			Cell 2		
			T1	T2	T3	T1	T2	T3
RF Channel Number		1, 2	1			2		
TDD configuration		1	TDDConf.1.1			TDDConf.1.1		
		2	TDDConf.2.1			TDDConf.2.1		
PDSCH RMC configuration		1	SR.1.1 FDD			N/A		
		2	SR.1.1 TDD					
RMSI CORESET RMC configuration		1	CR.1.1 TDD			CR.1.1 TDD		
		2	CR.2.1 TDD			CR.2.1 TDD		
Dedicated CORESET RMC configuration		1	CCR.1.1 TDD			CCR.1.1 TDD		
		2	CCR.2.1 TDD			CCR.2.1 TDD		
OCNG Pattern		1, 2	OP.1 defined in TBD			OP.1 defined in TBD		
TRS configuration		1	TRS.1.1 TDD			N/A		
		2	TRS.1.2 TDD					
Initial DL BWP configuration		1, 2	DLBWP.0			DLBWP.0		
Initial UL BWP configuration		1, 2	ULBWP.0			ULBWP.0		
Active DL BWP configuration		1, 2	DLBWP.1.1	N/A	N/A	N/A	N/A	DLBW P.1.1
Active UL BWP configuration		1, 2	ULBWP.1.1	N/A	N/A	N/A	N/A	ULBW P.1.1
RLM-RS		1, 2	SSB			SSB		
$\hat{E}_s / I_{ot}$	dB	1, 2	4	-infinity	-infinity	-infinity	-infinity	7
$N_{oc}$ <sup>Note2</sup>	dBm/SCS	1	-98					
		2	-95					
$N_{oc}$ <sup>Note2</sup>	dBm/15 kHz	1, 2	-98					
$\hat{E}_s / N_{oc}$	dB	1, 2	4	-infinity	-infinity	-infinity	-infinity	7
SS-RSRP <sup>Note3</sup>	dBm/SCS	1	-94	-infinity	-infinity	-infinity	-infinity	-91
		2	-91	-infinity	-infinity	-infinity	-infinity	-88
I <sub>o</sub>	dBm/9.36 MHz	1	-64.59	-70.05	-70.05	-70.05	-70.05	-62.26
	dBm/38.16 MHz	2	-58.50	-63.94	-63.94	-63.94	-63.94	-56.15
Propagation Condition		1, 2	AWGN					
<p>Note 1: OCNG shall be used such that both cells are fully allocated and a constant total transmitted power spectral density is achieved for all OFDM symbols.</p> <p>Note 2: Interference from other cells and noise sources not specified in the test is assumed to be constant over subcarriers and time and shall be modelled as AWGN of appropriate power for <math>N_{oc}</math> to be fulfilled.</p> <p>Note 3: SS-RSRP levels have been derived from other parameters for information purposes. They are not settable parameters themselves.</p>								

### G.2.1.1.1.1.2 Test Requirements

The RRC re-establishment delay is defined as the time from the start of time period T3, to the moment when the IAB-MT starts to send PRACH preambles to cell 2 for sending the *RRCReestablishmentRequest* message to cell 2.

The RRC re-establishment delay to an unknown NR inter frequency cell shall be less than 14.5 s.

The rate of correct RRC re-establishments observed during repeated tests shall be at least 90%.

NOTE: The RRC re-establishment delay in the test is derived from the following expression:

$$T_{re-establish\_delay} = T_{IAB-MT\_re-establish\_delay} + T_{UL\_grant}$$



Where:

$T_{UL\_grant}$  = It is the time required to acquire and process uplink grant from the target cell. The PRACH reception is used as a trigger for the completion of the test; hence  $T_{UL\_grant}$  is not used.

$$T_{IAB-MT\_re-establish\_delay} = 400 \text{ ms} + T_{identify\_intra\_NR} + \sum_{i=1}^{N_{freq}-1} T_{identify\_inter\_NR,i} + T_{SI-NR} + T_{PRACH}$$

$$N_{freq} = 2$$

$$T_{identify\_intra\_NR} = 6400 \text{ ms}$$

$$T_{identify\_inter\_NR} = 6400 \text{ ms}$$

$T_{SI} = 1280 \text{ ms}$ ; it is the time required for receiving all the relevant system information as defined in TS 38.331 for the target inter-frequency NR cell.

$T_{PRACH} = 15 \text{ ms}$ ; it is the additional delay caused by the random access procedure.

This gives a total of 14495 ms, allow 14.5 s in the test case.

#### G.2.1.1.1.2 Intra-frequency RRC Re-establishment in FR1 without serving cell timing for LA IAB-MT

##### G.2.1.1.1.2.1 Test Purpose and Environment

The purpose is to verify that the NR intra-frequency RRC re-establishment delay in FR1 without serving cell timing is within the specified limits. These tests will verify the requirements in clause 12.1.1.1. This test case is applicable only for local area IAB-MT and for IAB type 1-H.

The test parameters are given in table G.2.1.1.1.2.1-1, table G.2.1.1.1.2.1-2 and table G.2.1.1.1.2.1-3 below. The test consists of 3 successive time periods, with time duration of T1, T2 and T3 respectively. At the start of time period T2, cell 1, which is the active cell, is deactivated. The time period T3 starts after the occurrence of the radio link failure.

**Table G.2.1.1.1.2.1-1: Supported test configurations**

Configuration	Description
1	15 kHz SSB SCS, 10 MHz bandwidth, TDD duplex mode
2	30 kHz SSB SCS, 40 MHz bandwidth, TDD duplex mode
Note:	The IAB-MT is only required to be tested in one of the supported test configurations.

**Table G.2.1.1.2.1-2: General test parameters for NR intra-frequency RRC Re-establishment test case in FR1**

Parameter		Unit	Test configuration	Value	Comment
Initial condition	Active cell		1, 2	Cell1	
	Neighbour cells		1, 2	Cell2	
Final condition	Active cell		1, 2	Cell2	
RF Channel Number			1, 2	1, 2	
Time offset between cells			1, 2	3 $\mu$ s	Synchronous cells
N310		-	1, 2	1	Maximum consecutive out-of-sync indications from lower layers
N311		-	1, 2	1	Minimum consecutive in-sync indications from lower layers
T310		ms	1, 2	6000	Radio link failure timer configured by <i>RLF-TimersAndConstants</i>
T311		ms	1, 2	15000	RRC re-establishment timer
Access Barring Information		-	1, 2	Not Sent	No additional delays in random access procedure.
SSB configuration			1	SSB.1 FR1	
			2	SSB.2 FR1	
SMTC configuration			1	SMTC pattern 1	
			2	SMTC pattern 1	
DRX cycle length		s	1, 2	OFF	
PRACH configuration			1, 2	FR1 PRACH configuration 1	TBD
T1		s	1, 2	10	
T2		s	1, 2	7	Time for the IAB-MT to detect RLF
T3		s	1, 2	10	

**Table G.2.1.1.2.1-3: Cell specific test parameters for NR intra-frequency RRC Re-establishment test case in FR1**

Parameter	Unit	Test configuration	Cell 1			Cell 2		
			T1	T2	T3	T1	T2	T3
TDD configuration		1	TDDConf.1.1			TDDConf.1.1		
		2	TDDConf.2.1			TDDConf.2.1		
PDSCH RMC configuration		1	SR.1.1 TDD			N/A		
		2	SR.2.1 TDD					
RMSI CORESET RMC configuration		1	CR.1.1 TDD			CR.1.1 TDD		
		2	CR.2.1 TDD			CR.2.1 TDD		
Dedicated CORESET RMC configuration		1	CCR.1.1 TDD			CCR.1.1 TDD		
		2	CCR.2.1 TDD			CCR.2.1 TDD		
OCNG Pattern		1, 2	OP.1 defined in TBD			OP.1 defined in TBD		
Initial DL BWP configuration		1, 2	DLBWP.0.1			DLBWP.0.1		
Initial UL BWP configuration		1, 2	ULBWP.0.1			ULBWP.0.1		
RLM-RS		1, 2	SSB			SSB		
$\hat{E}_s / I_{ot}$	dB	1, 2	4	-infinity	-infinity	-infinity	-infinity	4
$N_{oc}$ Note2	dBm/SCS	1	-98					
		2	-95					
$N_{oc}$ Note2	dBm/15 kHz	1, 2	-98					
$\hat{E}_s / N_{oc}$	dB	1, 2	4	-infinity	-infinity	-infinity	-infinity	4
SS-RSRP Note3	dBm/SCS	1	-94	-infinity	-infinity	-infinity	-infinity	-94
		2	-91	-infinity	-infinity	-infinity	-infinity	-91
I <sub>o</sub>	dBm/9.36 MHz	1	-64.59	-infinity	-infinity	-infinity	-infinity	-64.59
	dBm/9.36 MHz	2	-58.50	-infinity	-infinity	-infinity	-infinity	-58.50
Propagation Condition		1, 2	AWGN					
Note 1: OCNG shall be used such that both cells are fully allocated and a constant total transmitted power spectral density is achieved for all OFDM symbols.								
Note 2: Interference from other cells and noise sources not specified in the test is assumed to be constant over subcarriers and time and shall be modelled as AWGN of appropriate power for $N_{oc}$ to be fulfilled.								
Note 3: SS-RSRP levels have been derived from other parameters for information purposes. They are not settable parameters themselves.								

### G.2.1.1.2.2 Test Requirements

The RRC re-establishment delay is defined as the time from the start of time period T3, to the moment when the IAB-MT starts to send PRACH preambles to cell 2 for sending the *RRCReestablishmentRequest* message to cell 2.

The RRC re-establishment delay to an unknown NR intra frequency cell without serving cell timing shall be less than 8.1 s.

The rate of correct RRC re-establishments observed during repeated tests shall be at least 90%.

NOTE: The RRC re-establishment delay in the test is derived from the following expression:

$$T_{re-establish\_delay} = T_{IAB-MT\_re-establish\_delay} + T_{UL\_grant}$$

Where:

$T_{UL\_grant}$  = It is the time required to acquire and process uplink grant from the target cell. The PRACH reception is used as a trigger for the completion of the test; hence  $T_{UL\_grant}$  is not used.

$$T_{IAB-MT\_re-establish\_delay} = 400 \text{ ms} + T_{identify\_intra\_NR} + \sum_{i=1}^{N_{freq}-1} T_{identify\_inter\_NR,i} + T_{SI-NR} + T_{PRACH}$$

$$N_{freq} = 1$$

$$T_{identify\_intra\_NR} = 6400 \text{ ms}$$

$T_{SI} = 1280 \text{ ms}$ ; it is the time required for receiving all the relevant system information as defined in TS 38.331 [2] for the target intra-frequency NR cell.

$T_{PRACH} = 15 \text{ ms}$ ; it is the additional delay caused by the random access procedure.

This gives a total of 8095 ms, allow 8.1 s in the test case.

### G.2.1.1.1.3 Inter-frequency RRC Re-establishment in FR2-1 for LA IAB-MT

#### G.2.1.1.1.3.1 Test Purpose and Environment

The purpose is to verify that the NR inter-frequency RRC re-establishment delay in FR2-1 without known target cell is within the specified limits. These tests will verify the requirements in clause 12.1.1.1. This test case is applicable only for local area IAB-MT and for IAB type 2-O.

The test parameters are given in table G.2.1.1.1.3.1-1, table G.2.1.1.1.3.1-2 and table G.2.1.1.1.3.1-3 below. The test consists of 3 successive time periods, with time duration of T1, T2 and T3 respectively. At the start of time period T2, cell 1, which is the active cell, becomes inactive. The time period T3 starts after the occurrence of the radio link failure. During T1, the IAB-MT shall be configured with the carrier frequency of cell 2 (with RF Channel Number #2) to ensure that the IAB-MT has the context of the carrier frequency of cell 2 by the end of T1.

**Table G.2.1.1.1.3.1-1: Supported test configurations**

Configuration	Description
1	NR 120 kHz SSB SCS, 100 MHz bandwidth, TDD duplex mode

**Table G.2.1.1.1.3.1-2: General test parameters for NR inter-frequency RRC Re-establishment test case in FR2-1**

Parameter		Unit	Test configuration	Value	Comment
Initial condition	Active cell		1	Cell1	
	Neighbour cells		1	Cell2	
Final condition	Active cell		1	Cell2	
RF Channel Number			1	1, 2	
Time offset between cells			1	3 $\mu$ s	Synchronous cells
N310		-	1	1	Maximum consecutive out-of-sync indications from lower layers
N311		-	1	1	Minimum consecutive in-sync indications from lower layers
T310		ms	1	0	Radio link failure timer; T310 is disabled
T311		ms	1	30000	RRC re-establishment timer
Access Barring Information		-	1	Not Sent	No additional delays in random access procedure.
SSB configuration			1	SSB.1 FR2-1	
			1	SMTC pattern 1	
DRX cycle length		s	1	OFF	
PRACH configuration			1	FR2-1 PRACH configuration 1	Table TBD
T1		s	1	10	
T2		ms	1	4800	Time for the IAB-MT to detect RLF
T3		s	1	20	

**Table G.2.1.1.3.1-3: Cell specific test parameters for NR inter-frequency RRC Re-establishment test case in FR2-1**

Parameter	Unit	Test configuration	Cell 1			Cell 2		
			T1	T2	T3	T1	T2	T3
AoA setup		1	Setup 2 as specified in clause G.1.8.2					
TDD configuration		1	TDDConf.3.1			TDDConf.3.1		
PDSCH RMC configuration		1	SR.3.1 TDD			N/A		
RMSI CORESET RMC configuration		1	CR.3.1 TDD			CR.3.1 TDD		
Dedicated CORESET RMC configuration		1	CCR.3.1 TDD			CCR.3.1 TDD		
TRS configuration		1	TRS.2.1 TDD			N/A		
PDSCH/PDCCH TCI state		1	TCI.State.2			N/A		
OCNG Pattern		1	OP.1 defined in TBD			OP.1 defined in TBD		
Initial DL BWP configuration		1	DLBWP.0.1			DLBWP.0.1		
Initial UL BWP configuration		1	ULBWP.0.1			ULBWP.0.1		
RLM-RS		1	SSB			SSB		
$\hat{E}_s / I_{ot}$	dB	1	5	-infinity	-infinity	-infinity	-infinity	8
$N_{oc}$ <sup>Note2</sup>	dBm/15 kHz	1	-98					
$N_{oc}$ <sup>Note2</sup>	dBm/SCS	1	-89					
$\hat{E}_s / N_{oc}$	dB	1	5	-infinity	-infinity	-infinity	-infinity	8
SS-RSRP <sup>Note3</sup>	dBm/SCS	1	-84	-infinity	-infinity	-infinity	-infinity	-81
Io	dBm/95.04 MHz	1	-53.82	-infinity	-infinity	-infinity	-infinity	-51.37
Propagation Condition		1	AWGN					
Note 1:	OCNG shall be used such that both cells are fully allocated and a constant total transmitted power spectral density is achieved for all OFDM symbols.							
Note 2:	Interference from other cells and noise sources not specified in the test is assumed to be constant over subcarriers and time and shall be modelled as AWGN of appropriate power for $N_{oc}$ to be fulfilled.							
Note 3:	SS-RSRP levels have been derived from other parameters for information purposes. They are not settable parameters themselves.							
Note 4:	Void							

### G.2.1.1.3.2 Test Requirements

The RRC re-establishment delay is defined as the time from the start of time period T3, to the moment when the IAB-MT starts to send PRACH preambles to cell 2 for sending the *RRCReestablishmentRequest* message to cell 2.

The RRC re-establishment delay to an unknown NR inter frequency cell shall be less than 18 s.

The rate of correct RRC re-establishments observed during repeated tests shall be at least 90%.

NOTE: The RRC re-establishment delay in the test is derived from the following expression:

$$T_{re-establish\_delay} = T_{IAB-MT\_re-establish\_delay} + T_{UL\_grant}$$

Where:

$T_{UL\_grant}$  = It is the time required to acquire and process uplink grant from the target cell. The PRACH reception is used as a trigger for the completion of the test; hence  $T_{UL\_grant}$  is not used.

$$T_{IAB-MT\_re-establish\_delay} = 400 \text{ ms} + T_{identify\_intra\_NR} + \sum_{i=1}^{N_{freq}-1} T_{identify\_inter\_NR,i} + T_{SI-NR} + T_{PRACH}$$

$$N_{freq} = 2$$

$$T_{\text{identify\_intra\_NR}} = 8000 \text{ ms}$$

$$T_{\text{identify\_inter\_NR}} = 8000 \text{ ms}$$

$T_{\text{SI}} = 1280 \text{ ms}$ ; it is the time required for receiving all the relevant system information as defined in TS 38.331 for the target inter-frequency NR cell.

$T_{\text{PRACH}} = 15 \text{ ms}$ ; it is the additional delay caused by the random access procedure.

This gives a total of 17695 ms, allow 18 s in the test case.

#### G.2.1.1.1.4 Intra-frequency RRC Re-establishment in FR2-1 without serving cell timing for LA IAB-MT

##### G.2.1.1.1.4.1 Test Purpose and Environment

The purpose is to verify that the NR intra-frequency RRC re-establishment delay in FR2-1 without serving cell timing is within the specified limits. These tests will verify the requirements in clause 12.1.1.1. This test case is applicable only for local area IAB-MT and for IAB type 2-O.

The test parameters are given in table G.2.1.1.1.4.1-1, table G.2.1.1.1.4.1-2 and table G.2.1.1.1.4.1-3 below. The test consists of 3 successive time periods, with time duration of T1, T2 and T3 respectively. At the start of time period T2, cell 1, which is the active cell, is deactivated. The time period T3 starts after the occurrence of the radio link failure.

**Table G.2.1.1.1.4.1-1: Supported test configurations**

Configuration	Description
1	120 kHz SSB SCS, 100 MHz bandwidth, TDD duplex mode

**Table G.2.1.1.1.4.1-2: General test parameters for NR intra-frequency RRC Re-establishment test case in FR2-1**

Parameter	Unit	Test configuration	Value	Comment
Initial condition	Active cell	1	Cell1	
	Neighbour cells	1	Cell2	
Final condition	Active cell	1	Cell2	
RF Channel Number		1	1	
Time offset between cells		1	3 $\mu\text{s}$	Synchronous cells
N310	-	1	1	Maximum consecutive out-of-sync indications from lower layers
N311	-	1	1	Minimum consecutive in-sync indications from lower layers
T310	ms	1	6000	Radio link failure timer configured by <i>RLF-TimersAndConstants</i>
T311	ms	1	30000	RRC re-establishment timer
Access Barring Information	-	1	Not Sent	No additional delays in random access procedure.
SSB configuration		1	SSB.1 FR2-1	
SMTTC configuration		1	SMTTC pattern 1	
DRX cycle length	s	1	OFF	
PRACH configuration		1	FR2-1 PRACH configuration 1	Table TBD
T1	s	1	10	
T2	s	1	10800	Time for the IAB-MT to detect RLF
T3	s	1	30	

**Table G.2.1.1.4.1-3: Cell specific test parameters for NR intra-frequency RRC Re-establishment test case in FR2-1**

Parameter	Unit	Test configuration	Cell 1			Cell 2		
			T1	T2	T3	T1	T2	T3
AoA setup		1	Setup 2 as specified in clause G.1.8.2					
TDD configuration		1	TDDConf.3.1			TDDConf.3.1		
		1	SR.3.1 TDD			N/A		
RMSI CORESET RMC configuration		1	CR.3.1 FDD			CR.3.1 FDD		
Dedicated CORESET RMC configuration		1	CCR.3.1 FDD			CCR.3.1 FDD		
TRS configuration		1	TRS.2.1 TDD			N/A		
TCI state		1	CSI-RS.Config.0			N/A		
OCNG Pattern		1	OP.1 defined in TBD			OP.1 defined in TBD		
Initial DL BWP configuration		1	DLBWP.0.1			DLBWP.0.1		
Initial UL BWP configuration		1	ULBWP.0.1			ULBWP.0.1		
RLM-RS		1	SSB			SSB		
AoA setup		1	Setup 1 defined in TBD			Setup 1 defined in TBD		
$\hat{E}_s / I_{ot}$	dB	1	5	-infinity	-infinity	-infinity	-infinity	5
$N_{oc}$ Note2	dBm/SCS	1	-98					
$N_{oc}$ Note2	dBm/15 kHz	1	-89					
$\hat{E}_s / N_{oc}$	dB	1	5	-infinity	-infinity	-infinity	-infinity	5
SS-RSRP Note3	dBm/SCS	1	-93	-infinity	-infinity	-infinity	-infinity	-93
Io	dBm/95.04 MHz	1	-62.82	-infinity	-infinity	-infinity	-infinity	-62.82
Propagation Condition		1	AWGN					
Note 1: OCNG shall be used such that both cells are fully allocated and a constant total transmitted power spectral density is achieved for all OFDM symbols.								
Note 2: Interference from other cells and noise sources not specified in the test is assumed to be constant over subcarriers and time and shall be modelled as AWGN of appropriate power for $N_{oc}$ to be fulfilled.								
Note 3: SS-RSRP levels have been derived from other parameters for information purposes. They are not settable parameters themselves.								
Note 4: Void								

#### G.2.1.1.4.2 Test Requirements

The RRC re-establishment delay is defined as the time from the start of time period T3, to the moment when the IAB-MT starts to send PRACH preambles to cell 2 for sending the *RRCReestablishmentRequest* message to cell 2.

The RRC re-establishment delay to an unknown NR intra frequency cell without serving cell timing shall be less than 30 s.

The rate of correct RRC re-establishments observed during repeated tests shall be at least 90%.

NOTE: The RRC re-establishment delay in the test is derived from the following expression:

$$T_{re-establish\_delay} = T_{IAB-MT\_re-establish\_delay} + T_{UL\_grant}$$

Where:

$T_{UL\_grant}$  = It is the time required to acquire and process uplink grant from the target cell. The PRACH reception is used as a trigger for the completion of the test; hence  $T_{UL\_grant}$  is not used.

$$T_{IAB-MT\_re-establish\_delay} = 400 \text{ ms} + T_{identify\_intra\_NR} + \sum_{i=1}^{N_{freq}-1} T_{identify\_inter\_NR,i} + T_{SI-NR} + T_{PRACH}$$

$$N_{freq} = 1$$



$T_{\text{identify\_intra\_NR}} = 28160 \text{ ms}$

$T_{\text{SI}} = 1280 \text{ ms}$ ; it is the time required for receiving all the relevant system information as defined in TS 38.331 [2] for the target intra-frequency NR cell.

$T_{\text{PRACH}} = 15 \text{ ms}$ ; it is the additional delay caused by the random access procedure.

This gives a total of 29855 ms, allow 30 s in the test case.

## G.2.1.1.2 RRC Connection Release with Redirection

### G.2.1.1.2.1 Redirection from NR in FR1 to NR in FR1

#### G.2.1.1.2.1.1 Test Purpose and Environment

This test is to verify RRC connection release with redirection from NR to NR requirements specified in clause 12.1.1.3.

#### G.2.1.1.2.1.2 Test Parameters

Supported test configurations are shown in table G.2.1.1.2.1.2-1. The time delay is tested by using the parameters in table G.2.1.1.2.1.2-2, and G.2.1.1.2.1.2-3.

The test consists of two successive time periods, with time duration of T1, and T2 respectively. The *RRCRelease* message shall be sent to the IAB-MT during period T1 and the start of T2 is the instant when the last TTI containing the RRC message is sent to the IAB-MT. Prior to time duration T2, the IAB-MT shall not have any timing information of Cell 2. Cell 2 is powered up at the beginning of the T2.

**Table G.2.1.1.2.1.2-1: Redirection from NR to NR test configurations**

Config	Description
1	Source cell: NR 15 kHz SSB SCS, TDD duplex mode Target cell: NR 15 kHz SSB SCS, TDD duplex mode
2	Source cell: NR 30 kHz SSB SCS, TDD duplex mode Target cell: NR 30 kHz SSB SCS, TDD duplex mode
Note 1: The IAB-MT is only required to be tested in one of the supported test configurations	

**Table G.2.1.1.2.1.2-2: General test parameters for Redirection from NR to NR test case**

Parameter	Unit	Value	Comment
Initial conditions	Active cell	Cell 1	
	Neighbouring cell	Cell 2	
Final condition	Active cell	Cell 2	
Filter coefficient		0	L3 filtering is not used
Access Barring Information	-	Not Sent	No additional delays in random access procedure.
Time offset between cells		3 $\mu\text{s}$	Synchronous cells
T1	s	5	
T2	s	8	

**Table G.2.1.1.2.1.2-3: Cell specific test parameters for Redirection from NR to NR test case**

Parameter		Unit	Cell 1		Cell 2	
			T1	T2	T1	T2
NR RF Channel Number			1		2	
BWP BW	Config 1	MHz	DLBWP.1.1			
	Config 2		DLBWP.1.1			
DRx Cycle		ms	Not Applicable			
PDSCH Reference measurement channel	Config 1		SR.1.1 TDD			
	Config 2		SR 2.1 TDD			
CORESET Reference Channel	Config 1		CR.1.1 TDD			
	Config 2		CR 2.1 TDD			
OCNG Patterns			OCNG pattern 1			
SSB configuration	Config 1		SSB.1 FR1			
	Config 2		SSB.2 FR1			
SMTc configuration	Config 1		SMTc.1 FR1			
	Config 2		SMTc.2 FR1			
PDSCH/PDCCH subcarrier spacing	Config 1	kHz	15 kHz			
	Config 2		30 kHz			
PUCCH/PUSCH subcarrier spacing	Config 1	kHz	15 kHz			
	Config 2		30 kHz			
BWP configuraiton	Initial DL BWP		DLBWP.0.1			
	Dedicated DL BWP		DLBWP.1.1			
	Initial UL BWP		ULBWP.0.1			
	Dedicated UL BWP		ULBWP.1.1			
EPRE ratio of PSS to SSS		dB	0			
EPRE ratio of PBCH DMRS to SSS						
EPRE ratio of PBCH to PBCH DMRS						
EPRE ratio of PDCCH DMRS to SSS						
EPRE ratio of PDCCH to PDCCH DMRS						
EPRE ratio of PDSCH DMRS to SSS						
EPRE ratio of PDSCH to PDSCH						
EPRE ratio of OCNG DMRS to SSS(Note 1)						
EPRE ratio of OCNG to OCNG DMRS (Note 1)						
$N_{oc}$ <sup>Note2</sup>		dBm/15kHz	-98			
$N_{oc}$ <sup>Note2</sup>	Config 1	dBm/SCS	-98			
	Config 2		-95			
$\hat{E}_s/I_{ot}$		dB	4	4	-infinity	4
$\hat{E}_s/N_{oc}$		dB	4	4	-infinity	4
$I_o$ <sup>Note3</sup>	Config 1	dBm/BW	Note3	Note3	Note3	Note3
	Config 2	dBm/BW	Note3	Note3	Note3	Note3
Propagation condition		-	AWGN			
<p>Note 1: OCNG shall be used such that both cells are fully allocated and a constant total transmitted power spectral density is achieved for all OFDM symbols.</p> <p>Note 2: Interference from other cells and noise sources not specified in the test is assumed to be constant over subcarriers and time and shall be modelled as AWGN of appropriate power for <math>N_{oc}</math> to be fulfilled.</p> <p>Note 3: <math>I_o</math> levels have been derived from other parameters for information purposes. They are not settable parameters themselves.</p>						

## G.2.1.1.2.1.3 Test Requirements

The IAB-MT shall start to transmit the PRACH to Cell 2 less than 7480 ms from the beginning of time period T2. The rate of correct RRC connection release redirection to NR observed during repeated tests shall be at least 90%.

NOTE: The redirection delay can be expressed as:

$$T_{\text{connection\_release\_redirect\_NR}} = T_{\text{RRC\_procedure\_delay}} + T_{\text{identify-NR}} + T_{\text{SI-NR}} + T_{\text{RACH}},$$

where:

$T_{\text{RRC\_procedure\_delay}} = 110$  ms in the test.

$T_{\text{identify-NR}} = 5440$  ms in the test.

$T_{\text{SI-NR}} = 1280$  ms, it is the time required for receiving all the relevant system information.

$T_{\text{RACH}} = 650$  ms in the test.

This gives a total of 7480 ms.

## G.2.1.1.2.2 Redirection from NR in FR2-1 to NR in FR2-1

## G.2.1.1.2.2.1 Test Purpose and Environment

This test is to verify RRC connection release with redirection from NR to NR requirements specified in clause 12.1.1.3.

## G.2.1.1.2.2.2 Test Parameters

Supported test configurations are shown in table G.2.1.1.2.2.2-1. The time delay is tested by using the parameters in table G.2.1.1.2.2.2-2, and G.2.1.1.2.2.2-3.

The test consists of two successive time periods, with time duration of T1, and T2 respectively. The *RRCRelease* message shall be sent to the IAB-MT during period T1 and the start of T2 is the instant when the last TTI containing the RRC message is sent to the IAB-MT. Prior to time duration T2, the IAB-MT shall not have any timing information of Cell 2. Cell 2 is powered up at the beginning of the T2.

**Table G.2.1.1.2.2.2-1: Redirection from NR to NR test configurations**

Config	Description
1	Source cell: NR 120 kHz SSB SCS, TDD duplex mode Target cell: NR 120 kHz SSB SCS, TDD duplex mode

**Table G.2.1.1.2.2.2-2: General test parameters for Redirection from NR to NR test case**

Parameter	Unit	Value	Comment
Initial conditions	Active cell	Cell 1	
	Neighbouring cell	Cell 2	
Final condition	Active cell	Cell 2	
Filter coefficient		0	L3 filtering is not used
Access Barring Information	-	Not Sent	No additional delays in random access procedure.
Time offset between cells		3 $\mu$ s	Synchronous cells
T1	s	5	
T2	s	10	

**Table G.2.1.1.2.2-3: Cell specific test parameters for Redirection from NR to NR test case**

Parameter	Unit	Cell 1		Cell 2		
		T1	T2	T1	T2	
AoA setup		1 AoA as defined in G.1.8				
NR RF Channel Number		1		2		
Duplex mode		TDD				
BWP BW	MHz	DLBWP.1.1				
DRx Cycle	ms	Not Applicable				
PDSCH Reference measurement channel		SR3.1 TDD				
CORESET Reference Channel		CR3.1 TDD				
OCNG Patterns		OCNG pattern 1				
SMTC configuration <sup>Note 6</sup>		SMTC.1 FR2-1				
PDSCH/PDCCH subcarrier spacing	kHz	120 kHz				
PUCCH/PUSCH subcarrier spacing	kHz	120 kHz				
TRS configuration		TRS.2.1 TDD				
TCI configuration <sup>Note 6</sup>		CSI-RS.Config.0				
BWP configuraiton	Initial DL BWP	DLBWP.0.1				
	Dedicated DL BWP	DLBWP.1.1				
	Initial UL BWP	ULBWP.0.1				
	Dedicated UL BWP	ULBWP.1.1				
EPRE ratio of PSS to SSS	dB	0		0		
EPRE ratio of PBCH DMRS to SSS						
EPRE ratio of PBCH to PBCH DMRS						
EPRE ratio of PDCCH DMRS to SSS						
EPRE ratio of PDCCH to PDCCH DMRS						
EPRE ratio of PDSCH DMRS to SSS						
EPRE ratio of PDSCH to PDSCH						
EPRE ratio of OCNG DMRS to SSS(Note 1)						
EPRE ratio of OCNG to OCNG DMRS (Note 1)						
$N_{oc}$ <sup>Note2</sup>	dBm/15kHz z	-104.7		-104.7		
$N_{oc}$ <sup>Note2</sup>	Config 1	-95.7		-95.7		
	Config 2	-95.7		-95.7		
$\hat{E}_s/I_{ot}$	dB	5	5	-Infinity	5	
$\hat{E}_s/N_{oc}$	dB	5	5	-Infinity	5	
$I_o$ <sup>Note3</sup>	Config 1	dBm/ BW	Note3	Note3	Note3	Note3
	Config 2	dBm/ BW	Note3	Note3	Note3	Note3
Propagation condition	-	AWGN				
Note 1:	OCNG shall be used such that both cells are fully allocated and a constant total transmitted power spectral density is achieved for all OFDM symbols.					
Note 2:	Interference from other cells and noise sources not specified in the test is assumed to be constant over subcarriers and time and shall be modelled as AWGN of appropriate power for $N_{oc}$ to be fulfilled.					
Note 3:	$I_o$ levels have been derived from other parameters for information purposes. They are not settable parameters themselves.					
Note 4:	Equivalent power received by an antenna with 0 dBi gain at the centre of the quiet zone					
Note 5:	As observed with 0 dBi gain antenna at the centre of the quiet zone					

**G.2.1.1.2.2.3 Test Requirements**

The IAB-MT shall start to transmit the PRACH to Cell 2 less than 9080 ms from the beginning of time period T2.

The rate of correct RRC connection release redirection to NR observed during repeated tests shall be at least 90%.

NOTE: The redirection delay can be expressed as:

$$T_{\text{connection\_release\_redirect\_NR}} = T_{\text{RRC\_procedure\_delay}} + T_{\text{identify-NR}} + T_{\text{SI-NR}} + T_{\text{RACH}},$$

where:

$T_{\text{RRC\_procedure\_delay}} = 110$  ms in the test.

$T_{\text{identify-NR}} = 7040$  ms in the test.

$T_{\text{SI-NR}} = 1280$  ms, it is the time required for receiving all the relevant system information.

$T_{\text{RACH}} = 650$  ms in the test.

This gives a total of 9080 ms.

## G.2.2 Timing

### G.2.2.1 Transmit timing

#### G.2.2.1.1 NR IAB-MT Transmit Timing Test for FR1

##### G.2.2.1.1.1 Test Purpose and environment

The purpose of this test is to verify that the IAB-MT can follow frame timing change of the connected gNodeB and that the IAB-MT initial transmit timing accuracy, maximum amount of timing change in one adjustment, minimum and maximum adjustment rate are within the specified limits. This test will verify the requirements in clause 12.2.1.2. Local area IAB-MT type 1-H shall be tested with this test.

Supported test configurations are shown in Table G.2.2.1.1.1-1.

**Table G.2.2.1.1.1-1: Supported test configurations for FR1 PCell**

Configuration	Description
1	NR TDD, SSB SCS 15 kHz, data SCS 15 kHz, BW 10 MHz
2	NR TDD, SSB SCS 30 kHz, data SCS 30 kHz, BW 40 MHz
Note:	The IAB-MT is only required to be tested in one of the supported test configurations

For this test a single NR cell (Cell 1) is used. Table G.2.2.1.1.1-2 defines the parameters to be configured and strength of the transmitted signals. The transmit timing is verified by the IAB-MT transmitting SRS using the configuration defined in Table G.2.2.1.1.1-3.

Table G.2.2.1.1-2: Cell Specific Test Parameters for UL Transmit Timing test

Parameter	Unit	Config	Test1
SSB ARFCN		1,2,3	1
TDD configuration		1	TDDConf.1.1
		2	TDDConf.1.2
BW <sub>channel</sub>	MHz	1	10: N <sub>RB,c</sub> = 52
		2	10: N <sub>RB,c</sub> = 52
		3	40: N <sub>RB,c</sub> = 106
Initial BWP Configuration		1,2,3	DLBWP.0.1 ULBWP.0.1
Dedicated BWP Configuration		1,2,3	DLBWP.1.1 ULBWP.1.1
DRX Cycle	ms		N/A
PDSCH Reference measurement channel		1	SR.1.1 TDD
		2	SR.2.1 TDD
RMSI CORESET Reference Channel		1	CR.1.1 TDD
		2	CR.2.1 TDD
Dedicated CORESET Reference Channel		1	CCR.1.1 TDD
		2	CCR.2.1 TDD
OCNG Patterns		1,2,3	OP.1
SSB configuration		1,2	SSB.1 FR1
		3	SSB.2 FR1
SMTc Configuration		1,2	SMTc.1
		3	SMTc.2
TRS configuration		1	TRS.1.1 TDD
		2	TRS.1.2 TDD
EPRE ratio of PSS to SSS	dB	1,2,3	0
EPRE ratio of PBCH DMRS to SSS			
EPRE ratio of PBCH to PBCH DMRS			
EPRE ratio of PDCCH DMRS to SSS			
EPRE ratio of PDCCH to PDCCH DMRS			
EPRE ratio of PDSCH DMRS to SSS			
EPRE ratio of PDSCH to PDSCH			
EPRE ratio of OCNG DMRS to SSS(Note 1)			
EPRE ratio of OCNG to OCNG DMRS (Note 1)			
$N_{oc}^{Note2}$			
$N_{oc}^{Note2}$	dBm/SCS	1,2	-98
		3	-95
$\hat{E}_s / I_{ot}$		1,2,3	3
$\hat{E}_s / N_{oc}$		1,2,3	3
SS-RSRP <sup>Note3</sup>	dBm/SCS	1,2	-95
		3	-92
I <sub>o</sub> <sup>Note3</sup>	dBm/9.36MHz	1,2	-65.2
	dBm/38.1MHz	3	-59.2
Propagation condition		1,2,3	AWGN
SRS Config		1,2	SRSCConf.1 <sup>Note5</sup>
		3	SRSCConf.1 <sup>Note5</sup>

Note 1:	OCNG shall be used such that the resources in Cell 1 are fully allocated and a constant total transmitted power spectral density is achieved for all OFDM symbols.
Note 2:	Interference from other cells and noise sources not specified in the test is assumed to be constant over subcarriers and time and shall be modelled as AWGN of appropriate power for $N_{oc}$ to be fulfilled.
Note 3:	SS-RSRP and $I_0$ levels have been derived from other parameters for information purposes. They are not settable parameters themselves.
Note 4:	SS-RSRP minimum requirements are specified assuming independent interference and noise at each receiver antenna port.
Note 5:	SRS configs are given in Table G.2.2.1.1.1-3

**Table G.2.2.1.1.1-3: SRS Configuration for Timing Accuracy Test**

	Field	SRSCConf.1	Comments
SRS-ResourceSet	srs-ResourceSetId	0	
	srs-ResourceIdList	0	
	resourceType	Periodic	
	Usage	Codebook	
SRS-Resource	SRS-ResourceId	0	
	nrofSRS-Ports	Port1	
	transmissionComb	n2	
	combOffset-n2	0	
	cyclicShift-n2	0	
	resourceMapping startPosition	0	
	resourceMapping nrofSymbols	n1	
	resourceMapping repetitionFactor	n1	
	freqDomainPosition	0	
	freqDomainShift	0	
	freqHopping c-SRS	14 for test configuration 1,2 25 for test configuration 3	Matches $N_{RB,c}$
	freqHopping b-SRS	0	
	freqHopping b-hop	0	
	groupOrSequenceHopping	Neither	
	resourceType	Periodic	
	periodicityAndOffset-p	sl1, 0	
sequencId	0	Any 10 bit number	

**G.2.2.1.1.2 Test requirements**

The test sequence shall be carried out in RRC\_CONNECTED for every test case.

Following will be the test sequence for this test

- 1) Setup NR PCell according to parameters given in Table G.2.2.1.1.1-1.
- 2) After connection set up with the cell, the test equipment will verify that the timing of the NR cell is within  $(N_{TA} + N_{TA\_offset}) \times T_c \pm T_e$  of the first path (in time) of DL SSB used by the IAB-MT to determine downlink timing is received from the reference cell at the IAB-MT antenna.
  - a. The  $N_{TA}$  offset value (in  $T_c$  units) is 25600
  - b. The  $T_e$  values depend on the DL and UL SCS for which the test is being run and are given in Table 12.2.1.2-1



- 3) The test system shall adjust the timing of the DL path by values given in Table G.2.2.1.1.2-1

**Table G.2.2.1.1.2-1: Adjustment Value for DL Timing**

SCS of SSB signals (KHz)	Adjustment Value
	Test1
15	+64*64T <sub>c</sub>
30	+32*64T <sub>c</sub>

- 4) The test system shall verify that the adjustment step size and the adjustment rate shall be according to requirements specified in clause 12.2.1.2 Table 12.2.1.2.1-1 until the IAB-MT transmit timing offset is within  $(N_{TA} + N_{TA\_offset}) \times T_c \pm T_e$  respective to the first path (in time) of DL SSB used by the IAB-MT to determine downlink timing is received from the reference cell at the IAB-MT antenna.
- 5) The test system shall verify that the IAB-MT transmit timing offset stays within  $(N_{TA} + N_{TA\_offset}) \times T_c \pm T_e$  of the first path (in time) of DL SSB used by the IAB-MT to determine downlink timing is received from the reference cell at the IAB-MT antenna.

## G.2.2.1.2 NR IAB-MT Transmit Timing Test for FR2-1

### G.2.2.1.2.1 Test Purpose and environment

The purpose of this test is to verify that the IAB-MT can follow frame timing change of the connected gNodeB and that the IAB-MT initial transmit timing accuracy, maximum amount of timing change in one adjustment, minimum and maximum adjustment rate are within the specified limits. This test will verify the requirements in clause 12.2.1.2. Local area IAB-MT type 2-O shall be tested with this test.

Supported test configurations are shown in Table G.2.2.1.2.1-1.

**Table G.2.2.1.2.1-1: Supported test configurations for FR2-1 PCell**

Configuration	Description
1	NR TDD, SSB SCS 240 kHz, data SCS 120 kHz, BW 100 MHz

For this test a single NR cell is used. Tables G.2.2.1.2.1-2 and Tables G.2.2.1.2.1-2A define the parameters to be configured and strength of the transmitted signals. The transmit timing is verified by the IAB-MT transmitting SRS using the configuration defined in Table G.2.2.1.2.1-3.

**Table G.2.2.1.2.1-2: Cell Specific Test Parameters for UL Transmit Timing test**

Parameter	Unit	Config	Test1	Test2
SSB ARFCN		1	Freq1	Freq1
BW <sub>channel</sub>	MHz	1	100: N <sub>RB,c</sub> = 66	
Initial BWP Configuration		1	DLBWP.0.1 ULBWP.0.1	
Dedicated BWP Configuration		1	DLBWP.1.1 ULBWP.1.1	
TRS Configuration		1	TRS.2.1 TDD	
TCI State		1	CSI-RS.Config.0	
DRx Cycle	ms		N/A	
PDSCH Reference measurement channel		1	SR.3.1 TDD	
RMSI CORESET Reference Channel		1	CR.3.1 TDD	
Dedicated CORESET Reference Channel		1	CCR.3.1 TDD	
OCNG Patterns		1	OP.1	
SSB Configuration		1	SSB.4 FR2-1	
SMTc Configuration		1	SMTc.1	
EPRE ratio of PSS to SSS	dB	1	0	0
EPRE ratio of PBCH DMRS to SSS				
EPRE ratio of PBCH to PBCH DMRS				
EPRE ratio of PDCCH DMRS to SSS				
EPRE ratio of PDCCH to PDCCH DMRS				
EPRE ratio of PDSCH DMRS to SSS				
EPRE ratio of PDSCH to PDSCH				
EPRE ratio of OCNG DMRS to SSS(Note 1)				
EPRE ratio of OCNG to OCNG DMRS (Note 1)				
Propagation condition				
SRS Config		1	SRSCConf.1 <sup>Note5</sup>	SRSCConf.2 <sup>Note5</sup>
<p>Note 1: OCNG shall be used such that both cells are fully allocated and a constant total transmitted power spectral density is achieved for all OFDM symbols.</p> <p>Note 2: Interference from other cells and noise sources not specified in the test is assumed to be constant over subcarriers and time and shall be modelled as AWGN of appropriate power for <math>N_{oc}</math> to be fulfilled.</p> <p>Note 3: SS-RSRP and I<sub>o</sub> levels have been derived from other parameters for information purposes. They are not settable parameters themselves.</p> <p>Note 4: SS-RSRP minimum requirements are specified assuming independent interference and noise at each receiver antenna port.</p> <p>Note 5: SRS configs are given in Table G.2.2.1.2.1-3</p>				

Table G.2.2.1.2.1-2A: OTA related test parameters

Parameter	Unit	Test 1	Test 2
Angle of arrival configuration		Setup 1 according to clause G.1.8	
$N_{oc}$ <sup>Note1</sup>	dBm/15kHz <sup>Note4</sup>	-112	
$N_{oc}$ <sup>Note1</sup>	dBm/SCS <sup>Note3</sup>	-103	
$\hat{E}_s/N_{oc}$	dB	4	
SS-RSRP <sup>Note2</sup>	dBm/SCS <sup>Note4</sup>	-99	
$\hat{E}_s/I_{ot}$	dB	4	
$I_o$ <sup>Note2</sup>	dBm/95.04 MHz <sup>Note4</sup>	-68.5	
Note 1:	Interference from other cells and noise sources not specified in the test is assumed to be constant over subcarriers and time and shall be modelled as AWGN of appropriate power for $N_{oc}$ to be fulfilled.		
Note 2:	SS-RSRP and $I_o$ levels have been derived from other parameters for information purposes. They are not settable parameters themselves.		
Note 3:	SS-RSRP minimum requirements are specified assuming independent interference and noise at each receiver antenna port.		
Note 4:	Equivalent power received by an antenna with 0dBi gain at the centre of the quiet zone		
Note 5:	As observed with 0dBi gain antenna at the centre of the quiet zone		

Table G.2.2.1.2.1-3: SRS Configuration for Timing Accuracy Test

	Field	SRSCnf.1	SRSCnf.2	Comments
SRS-ResourceSet	srs-ResourceSetId	0	0	
	srs-ResourceIdList	0	0	
	resourceType	Periodic	Periodic	
	Usage	Codebook	Codebook	
SRS-Resource	SRS-ResourceId	0	0	
	nrofSRS-Ports	Port1	Port1	
	transmissionComb	n2	n2	
	combOffset-n2	0	0	
	cyclicShift-n2	0	0	
	resourceMapping startPosition	0	0	
	resourceMapping nrofSymbols	n1	n1	
	resourceMapping repetitionFactor	n1	n1	
	freqDomainPosition	0	0	
	freqDomainShift	0	0	
	freqHopping c-SRS	17	17	Matches $N_{RB,c}$
	freqHopping b-SRS	0	0	
	freqHopping b-hop	0	0	
	groupOrSequenceHopping	Neither	Neither	
	resourceType	Periodic	Periodic	
periodicityAndOffset-p	sl1, 0	sl2560, 4		
sequenceId	0	0	Any 10 bit number	

## G.2.2.1.2.2 Test requirements

The test sequence shall be carried out in RRC\_CONNECTED for every test case.

Following will be the test sequence for this test:

- 1) Setup NR PCell according to parameters given in Table G.2.2.1.2.1-1.

- 2) After connection set up with the cell, the test equipment will verify that the timing of the NR cell is within  $(N_{TA} + N_{TA\_offset}) \times T_c \pm T_e$  of the first path (in time) of DL SSB used by the IAB-MT to determine downlink timing is received from the reference cell at the IAB-MT antenna.
  - a. The  $N_{TA}$  offset value (in  $T_c$  units) is 13792
  - b. The  $T_e$  values depend on the DL and UL SCS for which the test is being run and are given in Table 12.2.1.2-1
- 3) The test system shall adjust the timing of the DL path by values given in Table G.2.2.1.2.2-1

**Table G.2.2.1.2.2-1: Adjustment Value for DL Timing**

SCS of SSB signals (kHz)	Adjustment Value	
	Test1	Test2
240	$+8*64T_c$	$+4*64T_c$

- 4) The test system shall verify that the adjustment step size and the adjustment rate shall be according to requirements specified in clause 12.2.1.2 Table 12.2.1.2.1-1 until the IAB-MT transmit timing offset is within  $(N_{TA} + N_{TA\_offset}) \times T_c \pm T_e$  respective to the first path (in time) of DL SSB used by the IAB-MT to determine downlink timing is received from the reference cell at the IAB-MT antenna.
- 5) The test system shall verify that the IAB-MT transmit timing offset stays within  $(N_{TA} + N_{TA\_offset}) \times T_c \pm T_e$  of the first path (in time) of DL SSB used by the IAB-MT to determine downlink timing is received from the reference cell at the IAB-MT antenna.

## G.2.3 Signalling Characteristics for IAB MTs

### G.2.3.1 Radio link Monitoring

#### G.2.3.1.1 Radio Link Monitoring Out-of-sync Test for FR1 PCell configured with SSB-based RLM RS in non-DRX mode

##### G.2.3.1.1.1 Test Purpose and Environment

The purpose of this test is to verify that the IAB-MT properly detects the out of sync and in sync for the purpose of monitoring downlink radio link quality of the PCell. This test will partly verify the FR1 radio link monitoring requirements in clause 12.3.1.

In the test, IAB-MT is configured to perform RLM on SSB, with *detectionResource* included in *RadioLinkMonitoringRS* set to SSB#0 and SSB#1, and *purpose* set to 'rlf'. Supported test configurations are shown in table G.2.3.1.1.1-1. The test parameters are given in Tables G.2.3.1.1-2 and G.2.3.1.1-3 below. There is one cell (Cell 1), which is the active NR cell, in the test. The test consists of three successive time periods, with time duration of T1, T2 and T3 respectively. Figure G.2.3.1.1.1-1 shows the variation of the downlink SNR in the active cell to emulate out-of-sync and in-sync states. Prior to the start of the time duration T1, the IAB-MT shall be fully synchronized to Cell 1. The IAB-MT shall be configured for periodic CSI reporting with a reporting periodicity of 5 ms.

**Table G.2.3.1.1.1-1: Supported test configurations for FR1 PCell**

Configuration	Description
1	TDD, SSB SCS 15 kHz, data SCS 15 kHz, BW 10 MHz
2	TDD, SSB SCS 30 kHz, data SCS 30 kHz, BW 40 MHz
Note:	The IAB-MT is only required to pass in one of the supported test configurations in FR1

Table G.2.3.1.1-2: General test parameters for FR1 out-of-sync testing in non-DRX mode

Parameter		Unit	Value
			Test 1
Active PCell			Cell 1
RF Channel Number			1
Duplex mode	Config 1,2		TDD
BW <sub>channel</sub>	Config 1	MHz	10: N <sub>RB,c</sub> = 52
	Config 2		40: N <sub>RB,c</sub> = 106
DL initial BWP configuration	Config 1, 2		DLBWP.0.1
DL dedicated BWP configuration	Config 1, 2		DLBWP.1.1
UL initial BWP configuration	Config 1, 2		ULBWP.0.1
UL dedicated BWP configuration	Config 1, 2		ULBWP.1.1
TDD Configuration	Config 1		TDDConf.1.1
	Config 2		TDDConf.2.1
CORESET	Config 1		CR.1.1 TDD
Reference Channel	Config 2		CR.2.1 TDD
SSB Configuration	Config 1		SSB.1 FR1
	Config 2		SSB.2 FR1
SMTTC Configuration	Config 1		SMTTC.1
	Config 2		SMTTC.1
PDSCH/PDCCH subcarrier spacing	Config 1		15 kHz
	Config 2		30 kHz
PRACH Configuration	Config 1		TBD
	Config 2		TBD
SSB index assigned as RLM RS			0
OCNG parameters			OP.1
CP length			Normal
Correlation Matrix and Antenna Configuration			2x2 Low
Out of sync transmission parameters	DCI format		1-0
	Number of Control OFDM symbols		2
	Aggregation level	CCE	8
	Ratio of hypothetical PDCCH RE energy to average SSS RE energy	dB	4
	Ratio of hypothetical PDCCH DMRS energy to average SSS RE energy	dB	4
	DMRS precoder granularity		REG bundle size
	REG bundle size		6
DRX			OFF
Layer 3 filtering			Enabled
T310 timer		ms	0
T311 timer		ms	1000
N310			1
N311			1
CSI-RS configuration for CSI reporting	Config 1		CSI-RS.1.1 TDD
	Config 2		CSI-RS.2.1 TDD
CSI-RS for tracking	Config 1		TRS.1.1 TDD
	Config 2		TRS.1.2 TDD
T1		s	0.2
T2		s	1.08
T3		s	1.08
D1		s	1.04
Note 1: All configurations are assigned to the IAB-MT prior to the start of time period T1.			
Note 2: IAB-MT-specific PDCCH is not transmitted after T1 starts.			

**Table G.2.3.1.1.1-3: Cell specific test parameters for FR1 (Cell 1) for out-of-sync radio link monitoring tests in non-DRX mode**

Parameter		Unit	Test 1		
			T1	T2	T3
EPRE ratio of PDCCH DMRS to SSS		dB	4		
EPRE ratio of PDCCH to PDCCH DMRS		dB	0		
EPRE ratio of PBCH DMRS to SSS		dB	0		
EPRE ratio of PBCH to PBCH DMRS		dB			
EPRE ratio of PSS to SSS		dB			
EPRE ratio of PDSCH DMRS to SSS		dB			
EPRE ratio of PDSCH to PDSCH DMRS		dB			
EPRE ratio of OCNG DMRS to SSS		dB			
EPRE ratio of OCNG to OCNG DMRS		dB			
SNR on RLM-RS	Config 1	dB			
	Config 2		1	-7	-15
	Config 3		1	-7	-15
SNR on other channels and signals	Config 1, 2, 3	dB	1		
$N_{oc}$	Config 1	dBm/ SCS	-98		
	Config 2		-95		
Propagation condition			TDL-C 300ns 100Hz		
Note 1: OCNG shall be used such that the resources in Cell 1 are fully allocated and a constant total transmitted power spectral density is achieved for all OFDM symbols.					
Note 2: The signal contains PDCCH for IAB-MTs other than the device under test as part of OCNG.					
Note 3: SNR levels correspond to the signal to noise ratio over the SSS REs.					
Note 4: The SNR in time periods T1, T2 and T3 is denoted as SNR1, SNR2 and SNR3 respectively in Figure G.2.3.1.1.1-1.					
Note 5: The SNR values are specified for testing an IAB-MT which supports 2RX on at least one band. For testing of an IAB-MT which supports 4RX on all bands, the SNR during T3 is defined in clause G.1.3					

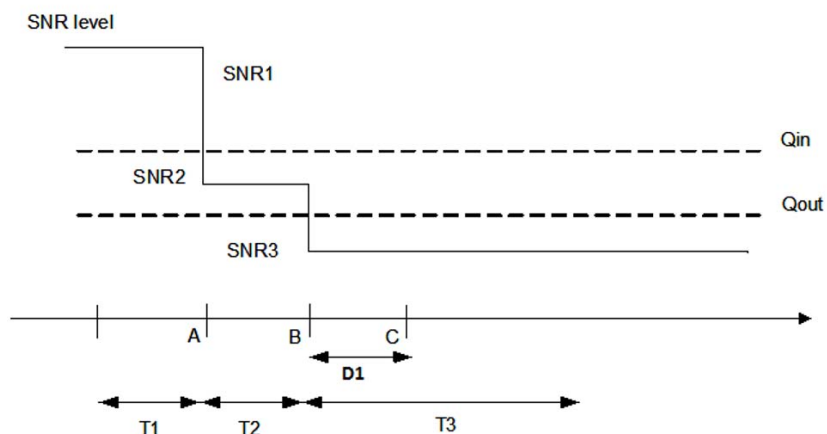

**Figure G.2.3.1.1.1-1: SNR variation for out-of-sync testing**

**G.2.3.1.1.2 Test Requirements**

The IAB-MT behaviour in each test during time durations T1, T2 and T3 shall be as follows:

During the period from time point A to time point B the IAB-MT shall transmit uplink signal at least in all uplink slots configured for CSI transmission according to the configured periodic CSI reporting.

The IAB-MT shall stop transmitting uplink signal no later than time point C (D1 second after the start of the time duration T3).

The rate of correct events observed during repeated tests shall be at least 90%.

### G.2.3.1.2 Radio Link Monitoring In-sync Test for FR1 PCell configured with SSB-based RLM RS in non-DRX mode

#### G.2.3.1.2.1 Test Purpose and Environment

The purpose of this test is to verify that the IAB-MT properly detects the out of sync and in sync for the purpose of monitoring downlink radio link quality of the PCell. This test will partly verify the FR1 radio link monitoring requirements in clause 12.3.1.

In the test, IAB-MT is configured to perform RLM on SSB, with *detectionResource* included in *RadioLinkMonitoringRS* set to SSB#0 and SSB#1, and *purpose* set to 'rlf'. Supported test configurations are shown in table G.2.3.1.2.1-1. The test parameters are given in Tables G.2.3.1.2.1-2, and G.2.3.1.2.1-3 below. There is one cell (Cell 1), which is the active cell, in the test. The test consists of five successive time periods, with time duration of T1, T2, T3, T4 and T5 respectively. Figure G.2.3.1.2.1-1 shows the variation of the downlink SNR in the active cell to emulate out-of-sync and in-sync states. Prior to the start of the time duration T1, the IAB-MT shall be fully synchronized to Cell 1. Prior to the start of the time duration T1, the IAB-MT shall be fully synchronized to Cell 1. The IAB-MT shall be configured for periodic CSI reporting with a reporting periodicity of 5 ms.

**Table G.2.3.1.2.1-1: Supported test configurations for FR1 PCell**

Configuration	Description
1	TDD, SSB SCS 15 kHz, data SCS 15 kHz, BW 10 MHz
2	TDD, SSB SCS 30 kHz, data SCS 30 kHz, BW 40 MHz
Note:	The IAB-MT is only required to pass in one of the supported test configurations in FR1

**Table G.2.3.1.2.1-2: General test parameters for FR1 in-sync testing in non-DRX mode**



Parameter		Unit	Value
			Test 1
Active PCell			Cell 1
RF Channel Number			1
Duplex mode	Config 1, 2		TDD
BW <sub>channel</sub>	Config 1	MHz	10: N <sub>RB,c</sub> = 52
	Config 2		40: N <sub>RB,c</sub> = 106
DL initial BWP configuration	Config 1, 2		DLBWP.0.1
DL dedicated BWP configuration	Config 1, 2		DLBWP.1.1
UL initial BWP configuration	Config 1, 2		ULBWP.0.1
UL dedicated BWP configuration	Config 1, 2		ULBWP.1.1
TDD Configuration	Config 1		TDDConf.1.1
	Config 2		TDDConf.2.1
CORESET Reference Channel	Config 1		CR.1.1 TDD
	Config 2		CR.2.1 TDD
SSB Configuration	Config 1		SSB.1 FR1
	Config 2		SSB.2 FR1
SMTC Configuration	Config 1,2		SMTC.1
PDSCH/PDCCH subcarrier spacing	Config 1		15 kHz
	Config 2		30 kHz
PRACH Configuration	Config 1		TBD
	Config 2		TBD
SSB index assigned as RLM RS			0
OCNG parameters			OP.1
CP length			Normal
Correlation Matrix and Antenna Configuration			2x2 Low
In sync transmission parameters	DCI format		1-0
	Number of Control OFDM symbols		2
	Aggregation level	CCE	4
	Ratio of hypothetical PDCCH RE energy to average SSS RE energy	dB	0
	Ratio of hypothetical PDCCH DMRS energy to average SSS RE energy	dB	0
	DMRS precoder granularity		REG bundle size
	REG bundle size		6
Out of sync transmission parameters	DCI format		1-0
	Number of Control OFDM symbols		2
	Aggregation level	CCE	8
	Ratio of hypothetical PDCCH RE energy to average SSS RE energy	dB	4
	Ratio of hypothetical PDCCH DMRS energy to average SSS RE energy	dB	4
	DMRS precoder granularity		REG bundle size
	REG bundle size		6
DRX			OFF
Layer 3 filtering			Enabled
T310 timer		ms	1000
T311 timer		ms	1000

N310		1
N311		1
CSI-RS configuration for CSI reporting	Config 1	CSI-RS.1.1 TDD
	Config 2	CSI-RS.2.1 TDD
CSI-RS for tracking	Config 1	TRS.1.1 TDD
	Config 2	TRS.1.2 TDD
T1	s	0.2
T2	s	0.2
T3	s	1.04
T4	s	0.2
T5	s	2.02
D1	s	1.98
Note 1: All configurations are assigned to the IAB-MT prior to the start of time period T1.		
Note 2: IAB-MT-specific PDCCH is not transmitted after T1 starts.		

**Table G.2.3.1.2.1-3: Cell specific test parameters for FR1 (Cell 1) for in-sync radio link monitoring tests in non-DRX mode**

Parameter	Unit	Test 1										
		T1	T2	T3	T4	T5						
EPRE ratio of PDCCH DMRS to SSS	dB	4										
EPRE ratio of PDCCH to PDCCH DMRS	dB	0										
EPRE ratio of PBCH DMRS to SSS	dB	0										
EPRE ratio of PBCH to PBCH DMRS	dB											
EPRE ratio of PSS to SSS	dB											
EPRE ratio of PDSCH DMRS to SSS	dB											
EPRE ratio of PDSCH to PDSCH DMRS	dB											
EPRE ratio of OCNG DMRS to SSS	dB											
EPRE ratio of OCNG to OCNG DMRS	dB											
SNR on RLM-RS	Config 1						dB	1	-7	-15	-4.5	1
	Config 2							1	-7	-15	-4.5	1
	Config 3		1	-7	-15	-4.5	1					
SNR on other channels and signals	Config 1, 2, 3	dB	1									
$N_{oc}$	Config 1	dBm/SCS	-98									
	Config 2		-95									
Propagation condition			TDL-C 300ns 100Hz									
Note 1: OCNG shall be used such that the resources in Cell 1 are fully allocated and a constant total transmitted power spectral density is achieved for all OFDM symbols.												
Note 2: The signal contains PDCCH for IAB-MTs other than the device under test as part of OCNG.												
Note 3: SNR levels correspond to the signal to noise ratio over the SSS REs.												
Note 4: The SNR in time periods T1, T2, T3, T4 and T5 is denoted as SNR1, SNR2, SNR3, SNR4 and SNR5 respectively in Figure G.2.3.1.2.1-1.												
Note 5: The SNR values are specified for testing an IAB-MT which supports 2RX on at least one band. For testing of an IAB-MT which supports 4RX on all bands, the SNR during T3 and T4 is modified as specified in clause G.1.3.												

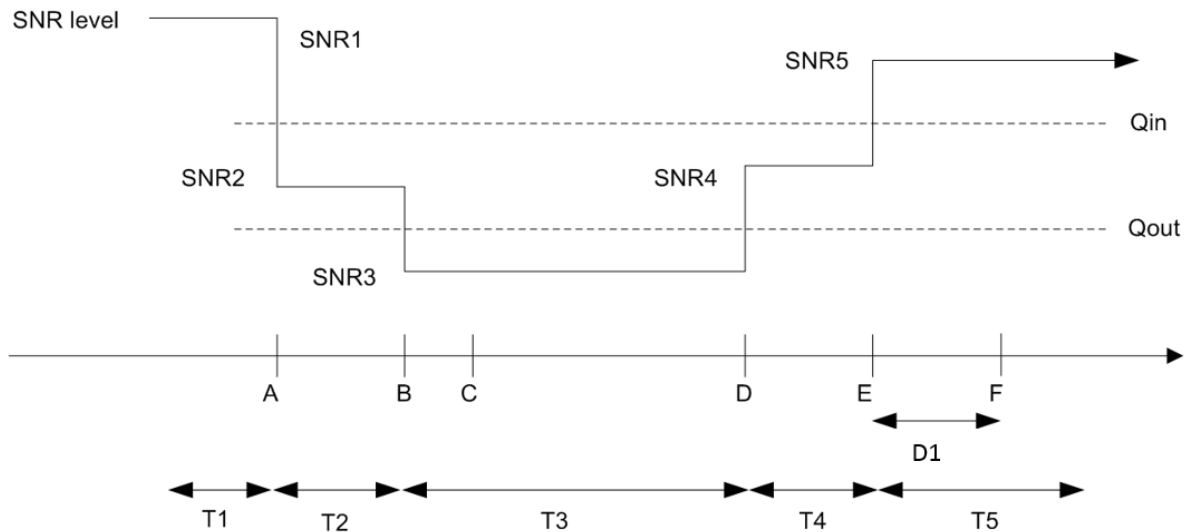

**Figure G.2.3.1.2.1-1: SNR variation for in-sync testing**

**G.2.3.1.2.2 Test Requirements**

The IAB-MT behaviour in each test during time durations T1, T2, T3, T4 and T5 shall be as follows:

During the period from time point A to time point F (D1 second after the start of time duration T5) the IAB-MT shall transmit uplink signal at least in all uplink slots configured for CSI transmission according to the configured periodic CSI reporting.

The rate of correct events observed during repeated tests shall be at least 90%.

**G.2.3.1.3 Radio Link Monitoring Out-of-sync Test for FR2-1 PCell configured with SSB-based RLM RS in non-DRX mode**

**G.2.3.1.3.1 Test Purpose and Environment**

The purpose of this test is to verify that the IAB-MT properly detects the out of sync and in sync for the purpose of monitoring downlink radio link quality of the PCell. This test will partly verify the FR2-1 radio link monitoring requirements in clause 12.3.1.

In the test, IAB-MT is configured to perform RLM on SSB, with *detectionResource* included in *RadioLinkMonitoringRS* set to SSB#0 and SSB#1, and *purpose* set to 'rlf'. Supported test configurations are shown in table G.2.3.1.3.1-1. The test parameters are given in Tables G.2.3.1.3.1-2 and G.2.3.1.3.1-3 below. There is one cell (Cell 1), which is the active NR cell, in the test. The test consists of three successive time periods, with time duration of T1, T2 and T3 respectively. Figure G.2.3.1.3.1-1 shows the variation of the downlink SNR in the active cell to emulate out-of-sync and in-sync states, and Figure G.2.3.1.3.1-2 shows the Time multiplexed downlink transmissions from each Angle of Arrival. Prior to the start of the time duration T1, the IAB-MT shall be fully synchronized to Cell 1. The IAB-MT shall be configured for periodic CSI reporting with a reporting periodicity of 5 ms.

**Table G.2.3.1.3.1-1: Supported test configurations for FR2-1 PCell**

Configuration	Description
1	TDD, SSB SCS 120 KHz, data SCS 120KHz, BW 100 MHz

**Table G.2.3.1.3.1-2: General test parameters for FR2-1 out-of-sync testing in non-DRX mode**

Parameter		Unit	Value
			Test 1
Active PCell			Cell 1
RF Channel Number			1
Duplex mode	Config 1		TDD
BW <sub>channel</sub>	Config 1		100: N <sub>RB,c</sub> = 66
DL initial BWP configuration	Config 1		DLBWP.0.1
DL dedicated BWP configuration	Config 1		DLBWP.1.1
UL initial BWP configuration	Config 1		ULBWP.0.1
UL dedicated BWP configuration	Config 1		ULBWP.1.1
TDD Configuration	Config 1		TDDConf.3.1
CORESET Reference Channel	Config 1		CR.3.1 TDD
SSB Configuration	Config 1		SSB.1 FR2-1
SMTTC Configuration	Config 1		SMTTC.1
PDSCH/PDCCH subcarrier spacing	Config 1		120 KHz
PRACH Configuration	Config 1		TBD
SSB index assigned as RLM RS	Config 1		0,1
OCNG parameters			OP.2
CP length			Normal
Out of sync transmission parameters	DCI format		1-0
	Number of Control OFDM symbols		2
	Aggregation level	CCE	8
	Ratio of hypothetical PDCCH RE energy to average SSS RE energy	dB	4
	Ratio of hypothetical PDCCH DMRS energy to average SSS RE energy	dB	4
	DMRS precoder granularity		REG bundle size
REG bundle size			6
DRX			OFF
Layer 3 filtering			<i>Enabled</i>
T310 timer		ms	0
T311 timer		ms	1000
N310			1
N311			1
CSI-RS for CSI reporting	Config 1		CSI-RS.3.1 TDD
TCI states for PDCCH/PDSCH			TCI.State.2
CSI-RS for tracking	Config 1		TRS.2.1 TDD
T1		s	0.2
T2		s	4.88
T3		s	4.88
D1		s	4.84
Note 1: All configurations are assigned to the IAB-MT prior to the start of time period T1.			
Note 2: IAB-MT-specific PDCCH is not transmitted after T1 starts.			

**Table G.2.3.1.3.1-3: OTA related cell specific test parameters for FR2-1 (Cell 1) for out-of-sync radio link monitoring tests in non-DRX mode**

Parameter	Unit	Test 1					
		T1	T2	T3	T1	T2	T3
AoA setup		Setup 2 as specified in clause G.1.8.2					
		AoA1			AoA2		

EPRE ratio of PDCCH DMRS to SSS	dB	4			Not sent			
EPRE ratio of PDCCH to PDCCH DMRS	dB	0						
EPRE ratio of PBCH DMRS to SSS	dB							
EPRE ratio of PBCH to PBCH DMRS	dB							
EPRE ratio of PSS to SSS	dB							
EPRE ratio of PDSCH DMRS to SSS	dB							
EPRE ratio of PDSCH to PDSCH DMRS	dB							
EPRE ratio of OCNG DMRS to SSS	dB							
EPRE ratio of OCNG to OCNG DMRS	dB							
ssb-Index 0 SNR	Config 1					dB	2 <sup>Note 6</sup>	-6 <sup>Note 6</sup>
ssb-Index 1 SNR	Config 1		Not sent			2 <sup>Note 6</sup>	-15	-15
SNR on other channels and signals	Config 1	dB	2 <sup>Note 6</sup>			N/A		
$N_{oc}$	Config 1	dBm/15kHz	-92.1			-92.1		
Time multiplexing of the downlink transmissions from each AoA			Defined in Figure G.2.3.1.3.1-2					
Propagation condition			TDL-A 30ns 75Hz			TDL-A 30ns 75Hz		
<p>Note 1: OCNG shall be used such that the resources in Cell 1 are fully allocated and a constant total transmitted power spectral density is achieved for all OFDM symbols.</p> <p>Note 2: The signal contains PDCCH for IAB-MTs other than the device under test as part of OCNG.</p> <p>Note 3: SNR levels correspond to the signal to noise ratio over the SSS REs.</p> <p>Note 4: The SNR values are specified for testing an IAB-MT which supports 2RX on at least one band. For testing of an IAB-MT which supports 4RX on all bands, the SNR during T3 is defined in clause G.1.3.</p> <p>Note 5: Void</p> <p>Note 6: This value allows up to 1dB degradation from applied SNR to IAB-MT baseband.</p>								

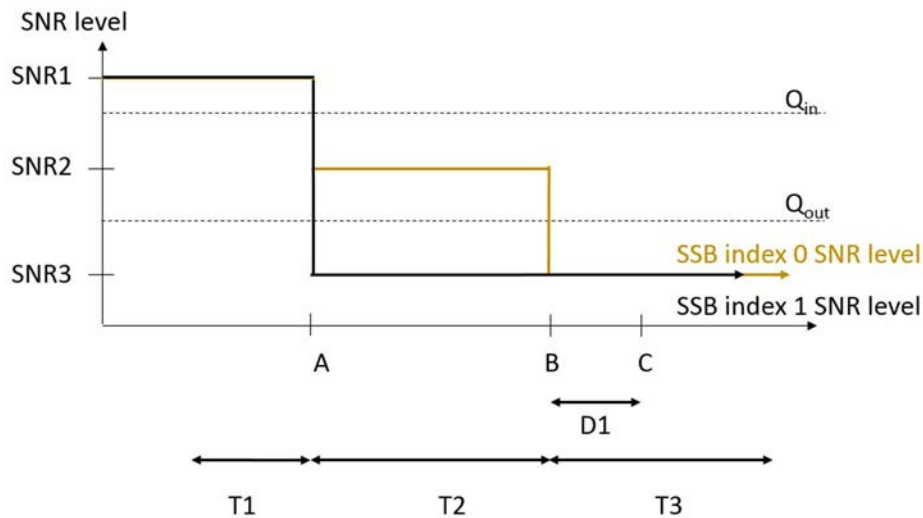
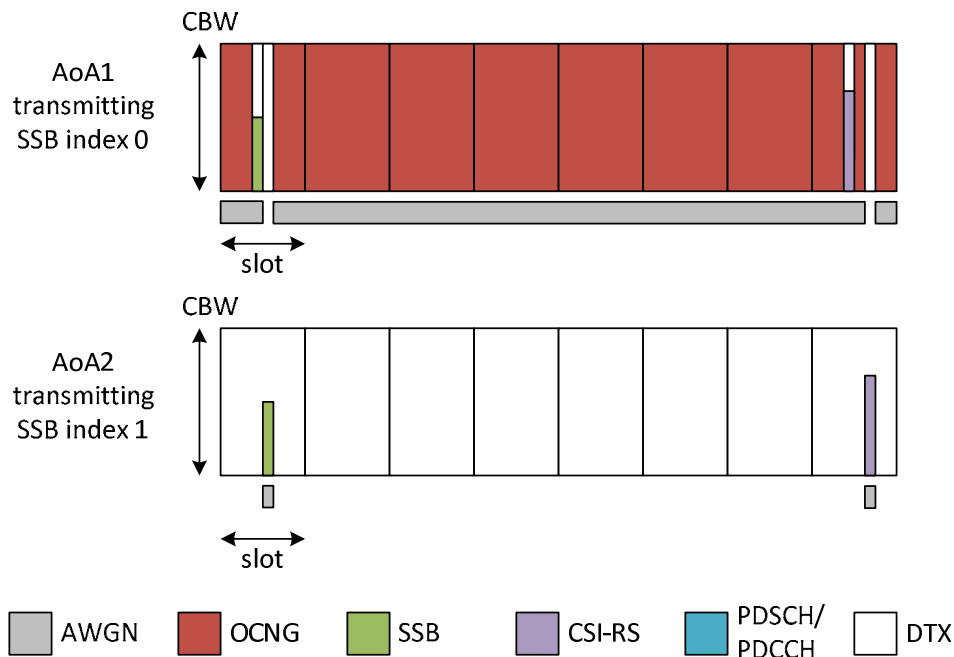

Figure G.2.3.1.3.1-1: SNR variation for out-of-sync testing



**Figure G.2.3.1.3.1-2: Time multiplexed downlink transmissions**

**G.2.3.1.3.2 Test Requirements**

The IAB-MT behavior in each test during time durations T1, T2 and T3 shall be as follows:

During the period from time point A to time point B the IAB-MT shall transmit uplink signal at least in all uplink slots configured for CSI transmission according to the configured periodic CSI reporting.

The IAB-MT shall stop transmitting uplink signal no later than time point C (D1 second after the start of the time duration T3).

The rate of correct events observed during repeated tests shall be at least 90%.

**G.2.3.1.4 Radio Link Monitoring In-sync Test for FR2-1 PCell configured with SSB-based RLM RS in non-DRX mode**

**G.2.3.1.4.1 Test Purpose and Environment**

The purpose of this test is to verify that the IAB-MT properly detects the out of sync and in sync for the purpose of monitoring downlink radio link quality of the PCell. This test will partly verify the FR2-1 radio link monitoring requirements in clause 12.3.1.

In the test, IAB-MT is configured to perform RLM on SSB, with *detectionResource* included in *RadioLinkMonitoringRS* set to SSB#0 and SSB#1, and *purpose* set to 'rlf'. Supported test configurations are shown in table G.2.3.1.4.1-1. The test parameters are given in Tables G.2.3.1.4.1-2, and G.2.3.1.4.1-3 below. There is one cell (Cell 1), which is the active cell, in the test. The test consists of five successive time periods, with time duration of T1, T2, T3, T4 and T5 respectively. Figure G.2.3.1.4.1-1 shows the variation of the downlink SNR in the active cell to emulate out-of-sync and in-sync states, and Figure G.2.3.1.4.1-2 shows the Time multiplexed downlink transmissions from each Angle of Arrival. Prior to the start of the time duration T1, the IAB-MT shall be fully synchronized to Cell 1. Prior to the start of the time duration T1, the IAB-MT shall be fully synchronized to Cell 1. The IAB-MT shall be configured for periodic CSI reporting with a reporting periodicity of 5 ms.

**Table G.2.3.1.4.1-1: Supported test configurations for FR2-1 PCell**

Configuration	Description
1	TDD, SSB SCS 120 KHz, data SCS 120KHz, BW 100 MHz

Table G.2.3.1.4.1-2: General test parameters for FR2-1 in-sync testing in non-DRX mode

Parameter		Unit	Value
			Test 1
Active PCell			Cell 1
RF Channel Number			1
Duplex mode	Config 1		TDD
BW <sub>channel</sub>	Config 1		100: N <sub>RB,c</sub> = 66
DL initial BWP configuration	Config 1		DLBWP.0.1
DL dedicated BWP configuration	Config 1		DLBWP.1.1
UL initial BWP configuration	Config 1		ULBWP.0.1
UL dedicated BWP configuration	Config 1		ULBWP.1.1
TDD Configuration	Config 1		TDDConf.3.1
CORESET Reference Channel	Config 1		CR.3.1 TDD
SSB Configuration	Config 1		SSB.1 FR2-1
SMTC Configuration	Config 1		SMTC.3
PDSCH/PDCCH subcarrier spacing	Config 1		120 KHz
PRACH Configuration	Config 1		TBD
SSB index assigned as RLM RS	Config 1		0,1
OCNG parameters			OP.2
CP length			Normal
In sync transmission parameters	DCI format		1-0
	Number of Control OFDM symbols		2
	Aggregation level	CCE	4
	Ratio of hypothetical PDCCH RE energy to average SSS RE energy	dB	0
	Ratio of hypothetical PDCCH DMRS energy to average SSS RE energy	dB	0
	DMRS precoder granularity		REG bundle size
	REG bundle size		6
Out of sync transmission parameters	DCI format		1-0
	Number of Control OFDM symbols		2
	Aggregation level	CCE	8
	Ratio of hypothetical PDCCH RE energy to average SSS RE energy	dB	4
	Ratio of hypothetical PDCCH DMRS energy to average SSS RE energy	dB	4
	DMRS precoder granularity		REG bundle size
	REG bundle size		6
DRX			OFF
Layer 3 filtering			<i>Enabled</i>
T310 timer		ms	4000
T311 timer		ms	1000
N310			1
N311			1
CSI-RS for CSI reporting	Config 1		CSI-RS.3.1 TDD
TCI states for PDCCH/PDSCH			TCI.State.2
CSI-RS for tracking	Config 1		TRS.2.1 TDD
T1		s	0.2
T2		s	0.2
T3		s	4.84
T4		s	0.2
T5		s	7.84
D1		s	7.8
Note 1: All configurations are assigned to the IAB-MT prior to the start of time period T1.			
Note 2: IAB-MT-specific PDCCH is not transmitted after T1 starts.			

**Table G.2.3.1.4.1-3: OTA related cell specific test parameters for FR2-1 (Cell 1) for in-sync radio link monitoring tests in non-DRX mode**

Parameter		Unit	Test 1									
			T1	T2	T3	T4	T5	T1	T2	T3	T4	T5
AoA setup			Setup 2 as specified in clause G.1.8.2									
			AoA1					AoA2				
EPRE ratio of PDCCH DMRS to SSS		dB	4					Not sent				
EPRE ratio of PDCCH to PDCCH DMRS		dB	0									
EPRE ratio of PBCH DMRS to SSS		dB										
EPRE ratio of PBCH to PBCH DMRS		dB										
EPRE ratio of PSS to SSS		dB										
EPRE ratio of PDSCH DMRS to SSS		dB										
EPRE ratio of PDSCH to PDSCH DMRS		dB										
EPRE ratio of OCNG DMRS to SSS		dB										
EPRE ratio of OCNG to OCNG DMRS		dB										
ssb-Index 0 SNR	Config 1	dB	<sup>2</sup> Note 6	<sup>-6</sup> Note 6	-15	-4.5	<sup>2</sup> Note 6					
ssb-Index 1 SNR	Config 1		Not sent					<sup>2</sup> Note 6	-15	-15	-15	-15
SNR on other channels and signals	Config 1	dB	<sup>2</sup> Note 6					N/A				
$N_{oc}$	Config 1	dBm/15kHz	-92.1					-92.1				
Time multiplexing of the downlink transmissions from each AoA			Defined in Figure G.2.3.1.4.1-2									
Propagation condition			TDL-A 30ns 75Hz					TDL-A 30ns 75Hz				
<p>Note 1: OCNG shall be used such that the resources in Cell 1 are fully allocated and a constant total transmitted power spectral density is achieved for all OFDM symbols.</p> <p>Note 2: The signal contains PDCCH for IAB-MTs other than the device under test as part of OCNG.</p> <p>Note 3: SNR levels correspond to the signal to noise ratio over the SSS REs.</p> <p>Note 4: The SNR values are specified for testing an IAB-MT which supports 2RX on at least one band. For testing of an IAB-MT which supports 4RX on all bands, the SNR during T3 is defined in clause G.1.3.</p> <p>Note 5: Void.</p> <p>Note 6: This value allows up to 1dB degradation from applied SNR to IAB-MT baseband</p>												



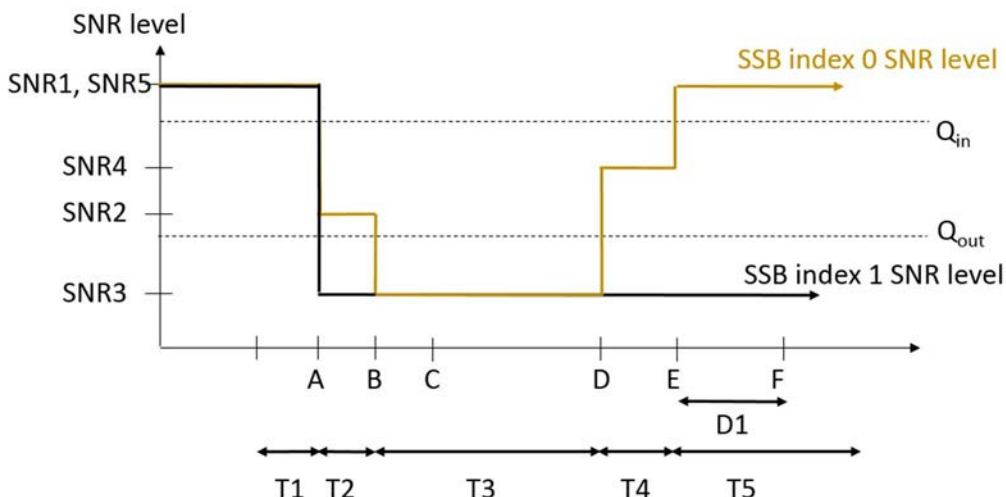

Figure G.2.3.1.4.1-1: SNR variation for in-sync testing

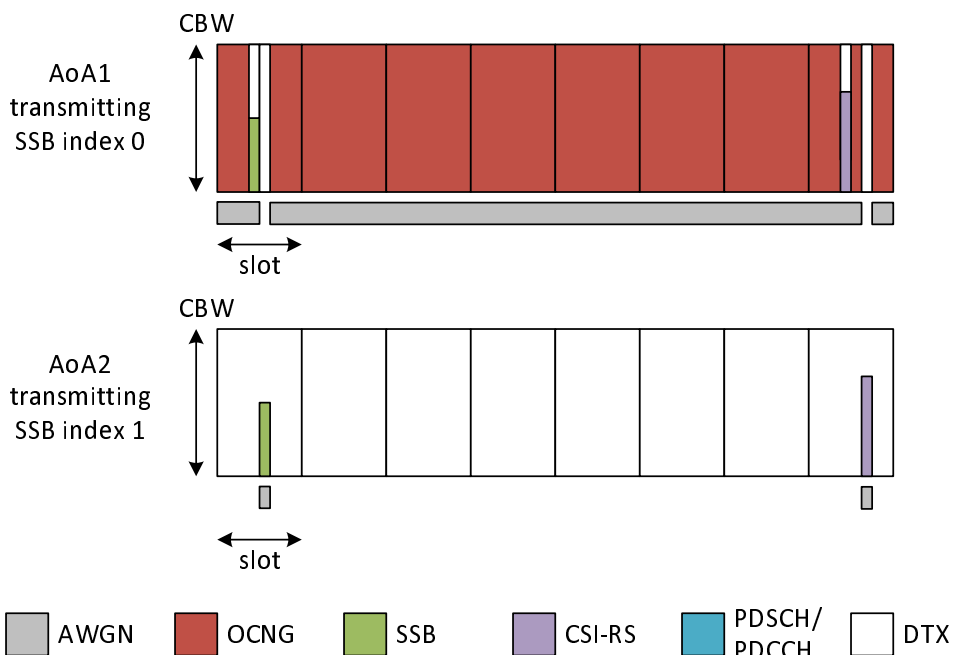

Figure G.2.3.1.4.1-2: Time multiplexed downlink transmissions

G.2.3.1.4.2 Test Requirements

The IAB-MT behaviour in each test during time durations T1, T2, T3, T4 and T5 shall be as follows:

During the period from time point A to time point F (D1 second after the start of time duration T5) the IAB-MT shall transmit uplink signal at least in all uplink slots configured for CSI transmission according to the configured periodic CSI reporting.

The rate of correct events observed during repeated tests shall be at least 90%.

### G.2.3.1.5 Radio Link Monitoring Out-of-sync Test for FR1 PCell configured with CSI-RS-based RLM in non-DRX mode

#### G.2.3.1.5.1 Test Purpose and Environment

The purpose of this test is to verify that the IAB-MT properly detects the out of sync for the purpose of monitoring downlink CSI-RS based radio link quality of the PCell. This test will partly verify the FR1 PCell CSI-RS Out-of-sync radio link monitoring requirements in clause 12.3.1.3. This test case is applicable only for local area IAB-MT and for IAB type 1-H.

The test parameters are given in Tables G.2.3.1.5.1-1, G.2.3.1.5.1-2 and G.2.3.1.5.1-3 below. There is one cell, cell 1 which is the PCell, in the test. The test consists of three successive time periods, with time duration of T1, T2 and T3 respectively. Figure G.2.3.1.5.1-1 shows the variation of the downlink SNR in the PCell to emulate out-of-sync and in-sync states. Prior to the start of the time duration T1, the IAB-MT shall be fully synchronized to cell 1. The IAB-MT shall be configured for periodic CSI reporting with a reporting periodicity defined in CSI-RS configuration. In the test, SSBO is configured as the BFD-RS.

**Table G.2.3.1.5.1-1: Supported test configurations for FR1 PCell**

<b>Configuration</b>	<b>Description</b>
1	TDD duplex mode, 15 kHz SSB SCS, 10 MHz bandwidth
2	TDD duplex mode, 30 kHz SSB SCS, 40 MHz bandwidth
Note: The IAB-MT is only required to pass in one of the supported test configurations in FR1	

**Table G.2.3.1.5.1-2: General test parameters for FR1 PCell for CSI-RS out-of-sync testing in non-DRX**

Parameter		Unit	IAB-MT Test 1
Active PCell			Cell 1
RF Channel Number			1
Duplex mode	Config 1, 2		TDD
TDD Configuration	Config 1		TDDConf.1.1
	Config 2		TDDConf.2.1
DL initial BWP configuration	Config 1, 2		DLBWP.0.1
DL dedicated BWP configuration	Config 1, 2		DLBWP.1.1
UL initial BWP configuration	Config 1, 2		ULBWP.0.1
UL dedicated BWP configuration	Config 1, 2		ULBWP.1.1
CORESET Reference Channel	Config 1		CR.1.1 TDD
	Config 2		CR.2.1 TDD
SSB Configuration	Config 1		SSB.1 FR1
	Config 2		SSB.2 FR1
SMTC Configuration	Config 1		SMTC.1
	Config 2		SMTC.1
PDSCH/PDCCH subcarrier spacing	Config 1		15 kHz
	Config 2		30 kHz
TRS configuration	Config 1		TRS.1.1 TDD
	Config 2		TRS.1.2 TDD
CSI-RS for RLM	Config 1		Resource #4 in TRS.1.1 TDD
	Config 2		Resource #4 in TRS.1.2 TDD
TCI configuration for PDCCH/PDSCH			TCI.State.2
OCNG parameters			OP.1
CP length			Normal
Correlation Matrix and Antenna Configuration			2x2 Low
Out of sync transmission parameters	DCI format		1-0
	Number of Control OFDM symbols		2
	Aggregation level	CCE	8
	Ratio of hypothetical PDCCH RE energy to average CSI-RS RE energy	dB	4
	Ratio of hypothetical PDCCH DMRS energy to average CSI-RS RE energy	dB	4
	DMRS precoder granularity		REG bundle size
	REG bundle size		6
Layer 3 filtering			<i>Enabled</i>
T310 timer		ms	0
T311 timer		ms	1000
N310			1
N311			1
CSI-RS configuration for CSI reporting	Config 1		CSI-RS.1.1 TDD
	Config 2		CSI-RS.2.1 TDD
T1		s	0.2
T2		s	48
T3		s	0.48
D1		s	0.44
Note 1: IAB-MT-specific PDCCH is not transmitted after T1 starts.			

**Table G.2.3.1.5.1-3: Cell specific test parameters for FR1 for CSI-RS out-of-sync radio link monitoring in non-DRX**

Parameter		Unit	Test 1		
			T1	T2	T3
PDCCH_beta		dB	4		
PDCCH_DMRS_beta		dB	4		
PBCH_beta		dB	0		
PSS_beta		dB			
SSS_beta		dB			
PDSCH_beta		dB			
OCNG_beta		dB			
SNR on RLM-RS	Config 1, 2	dB	1	-7	-15
SNR on other channels and signals	Config 1, 2	dB	1		
$N_{oc}$	Config 1, 2	dBm/15kHz	-98		
Propagation condition			TDL-C 300ns 100Hz		
<p>Note 1: OCNG shall be used such that the resources in Cell 1 are fully allocated and a constant total transmitted power spectral density is achieved for all OFDM symbols.</p> <p>Note 2: The uplink resources for CSI reporting are assigned to the IAB-MT prior to the start of time period T1.</p> <p>Note 3: NZP CSI-RS resource set configuration for CSI reporting are assigned to the IAB-MT prior to the start of time period T1.</p> <p>Note 4: The timers and layer 3 filtering related parameters are configured prior to the start of time period T1.</p> <p>Note 5: The signal contains PDCCH for IAB-MTs other than the device under test as part of OCNG.</p> <p>Note 6: SNR levels correspond to the signal to noise ratio over the SSS REs.</p> <p>Note 7: The SNR in time periods T1, T2 and T3 is denoted as SNR1, SNR2 and SNR3 respectively in figure G.2.3.1.5.1-1.</p> <p>Note 8: The SNR IAB-MTs are specified for testing a IAB-MT which supports 2RX on at least one band. For testing of IAB-MT which supports 4RX on all bands, the SNR during T3 is specified in clause G.1.3.1.1.</p>					

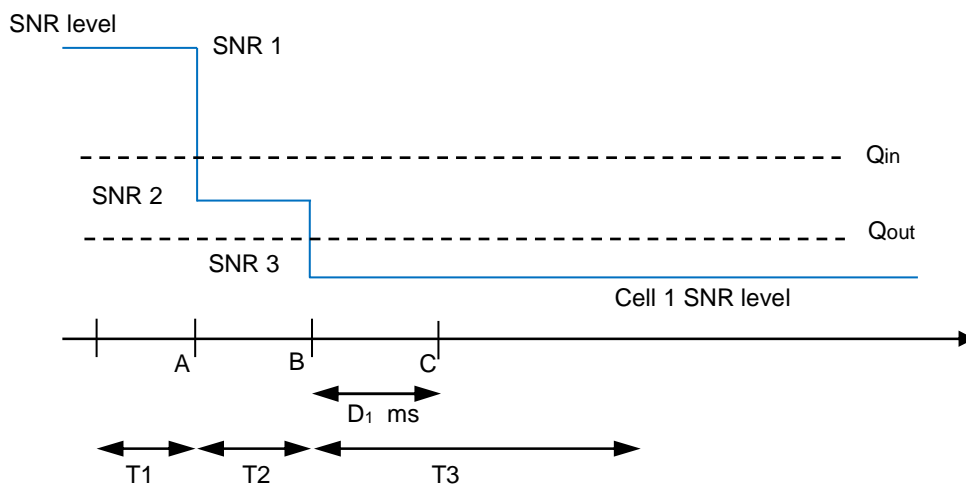

**Figure G.2.3.1.5.1-1: SNR variation for CSI-RS out-of-sync testing**

**G.2.3.1.5.2 Test Requirements**

The IAB-MT behaviour during time durations T1, T2, and T3 shall be as follows:

During time durations T1, T2 and T3, the IAB-MT shall transmit uplink signal at least in all subframes configured for CSI transmission on Cell 1.

During the period from time point A to time point B the IAB-MT shall transmit uplink signal in Cell 1 at least in all uplink slots configured for CSI transmission according to the configured periodic CSI reporting for Cell 1.

The IAB-MT shall stop transmitting uplink signal in Cell 1 no later than time point C ( $D_1$  ms after the start of the time duration T3) on the PCell.

The rate of correct events observed during repeated tests shall be at least 90%.

### G.2.3.1.6 Radio Link Monitoring In-sync Test for FR1 PCell configured with CSI-RS-based RLM in non-DRX mode

#### G.2.3.1.6.1 Test Purpose and Environment

The purpose of this test is to verify that the IAB-MT properly detects the in sync for the purpose of monitoring downlink CSI-RS based radio link quality of the PCell. This test will partly verify the FR1 PCell CSI-RS In-sync radio link monitoring requirements in clause 12.3.1.3. This test case is applicable only for local area IAB-MT and for IAB type 1-H.

The test parameters are given in Tables G.2.3.1.6.1-1, G.2.3.1.6.1-2, and G.2.3.1.6.1-3 below. There is one cells, cell 1 which is the PCell, in the test. The test consists of five successive time periods, with time duration of T1, T2, T3, T4 and T5 respectively. Figure G.2.3.1.6.1-1 shows the variation of the downlink SNR in the PCell to emulate out-of-sync and in-sync states. Prior to the start of the time duration T1, the IAB-MT shall be fully synchronized to cell 1. The IAB-MT shall be configured for periodic CSI reporting with a reporting periodicity defined in CSI-RS configuration. In the test, SSB0 is configured as the BFD-RS.

**Table G.2.3.1.6.1-1: Supported test configurations for FR1 PCell**

Configuration	Description
1	TDD duplex mode, 15 kHz SSB SCS, 10 MHz bandwidth
2	TDD duplex mode, 30kHz SSB SCS, 40 MHz bandwidth
Note:	The IAB-MT is only required to pass in one of the supported test configurations in FR1

Table G.2.3.1.6.1-2: General test parameters for FR1 PCell for CSI-RS in-sync testing in non-DRX

Parameter		Unit	IAB-MT Test 1
Active PCell			Cell 1
RF Channel Number			1
Duplex mode	Config 1, 2		TDD
TDD Configuration	Config 1		TDDConf.1.1
	Config 2		TDDConf.2.1
DL initial BWP configuration	Config 1, 2		DLBWP.0.1
DL dedicated BWP configuration	Config 1, 2		DLBWP.1.1
UL initial BWP configuration	Config 1, 2		ULBWP.0.1
UL dedicated BWP configuration	Config 1, 2		ULBWP.1.1
CORESET Reference Channel	Config 1		CR.1.1 TDD
	Config 2		CR.2.1 TDD
SSB Configuration	Config 1		SSB.1 FR1
	Config 2		SSB.2 FR1
SMTC Configuration	Config 1, 2		SMTC.1
PDSCH/PDCCH subcarrier spacing	Config 1		15 kHz
	Config 2		30 kHz
TRS configuration	Config 1		TRS.1.1 TDD
	Config 2		TRS.1.2 TDD
CSI-RS for RLM	Config 1		Resource #4 in TRS.1.1 TDD
	Config 2		Resource #4 in TRS.1.2 TDD
TCI configuration for PDCCH/PDSCH			TCI.State.2
OCNG parameters			OP.1
CP length			Normal
Correlation Matrix and Antenna Configuration			2x2 Low
Out of sync transmission parameters	DCI format		1-0
	Number of Control OFDM symbols		2
	Aggregation level	CCE	8
	Ratio of hypothetical PDCCH RE energy to average CSI-RS RE energy	dB	4
	Ratio of hypothetical PDCCH DMRS energy to average CSI-RS RE energy	dB	4
	DMRS precoder granularity		REG bundle size
	REG bundle size		6
In sync transmission parameters	DCI format		1-0
	Number of Control OFDM symbols		2
	Aggregation level	CCE	4
	Ratio of hypothetical PDCCH RE energy to average CSI-RS RE energy	dB	0
	Ratio of hypothetical PDCCH DMRS energy to average CSI-RS RE energy	dB	0
	DMRS precoder granularity		REG bundle size
	REG bundle size		6
Layer 3 filtering			<i>Enabled</i>
T310 timer		ms	1000
T311 timer		ms	1000
N310			1
N311			1
CSI-RS configuration for CSI reporting	Config 1		CSI-RS.1.1 TDD
	Config 2		CSI-RS.2.1 TDD
T1		s	0.2
T2		s	0.2
T3		s	0.44
T4		s	0.2
T5		s	0.88
T6		s	0.84

Note 1: IAB-MT-specific PDCCH is not transmitted after T1 starts.

**Table G.2.3.1.6.1-3: Cell specific test parameters for FR1 for CSI-RS in-sync radio link monitoring in non-DRX**

Parameter		Unit	Test 1				
			T1	T2	T3	T4	T5
PDCCH_beta		dB	4				
PDCCH_DMRS_beta		dB	4				
PBCH_beta		dB	0				
PSS_beta		dB					
SSS_beta		dB					
PDSCH_beta		dB					
OCNG_beta		dB					
SNR on RLM-RS	Config 1, 2	dB	1	-7	-15	-4.5	1
SNR on other channels and signals	Config 1, 2	dB	1				
$N_{oc}$	Config 1, 2	dBm/15kHz	-98				
Propagation condition			TDL-C 300ns 100Hz				
<p>Note 1: OCNG shall be used such that the resources in Cell 1 are fully allocated and a constant total transmitted power spectral density is achieved for all OFDM symbols.</p> <p>Note 2: The uplink resources for CSI reporting are assigned to the IAB-MT prior to the start of time period T1.</p> <p>Note 3: NZP CSI-RS resource set configuration for CSI reporting are assigned to the IAB-MT prior to the start of time period T1.</p> <p>Note 4: The timers and layer 3 filtering related parameters are configured prior to the start of time period T1.</p> <p>Note 5: The signal contains PDCCH for IAB-MTs other than the device under test as part of OCNG.</p> <p>Note 6: SNR levels correspond to the signal to noise ratio over the SSS REs.</p> <p>Note 7: The SNR in time periods T1, T2, T3, T4 and T5 is denoted as SNR1, SNR2, SNR3, SNR4 and SNR5 respectively in figure G.2.3.1.6.1-1.</p> <p>Note 8: The SNR IAB-MTs are specified for testing a IAB-MT which supports 2RX on at least one band. For testing of IAB-MT which supports 4RX on all bands, the SNR during T3 is specified in clause G.1.3.1.1.</p>							

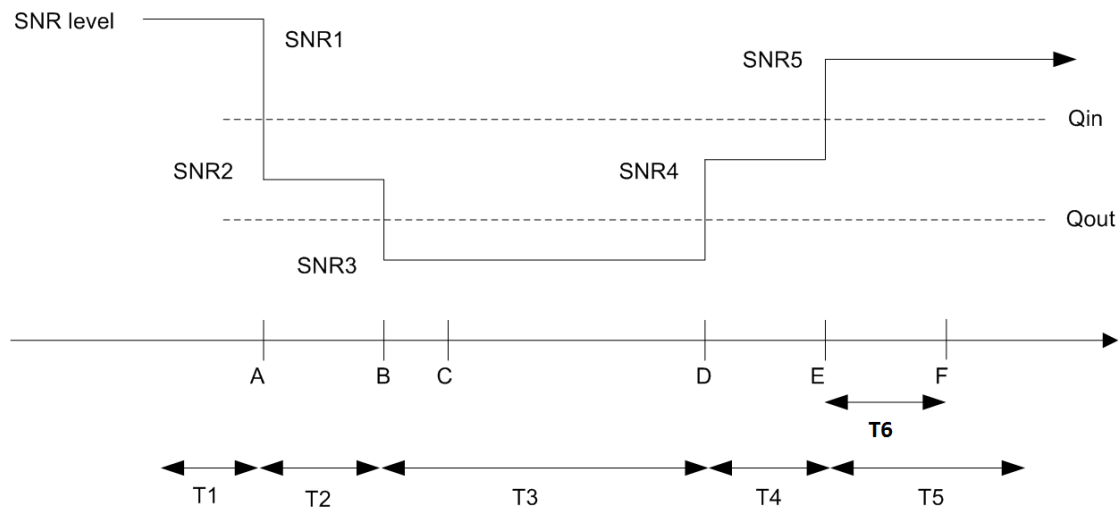

**Figure G.2.3.1.6.1-1: SNR variation for CSI-RS in-sync testing**

**G.2.3.1.6.2 Test Requirements**

The IAB-MT behaviour in each test during time durations T1, T2, T3, T4 and T5 shall be as follows:

During the period from time point A to time point F (T6 second after the start of time duration T5) the IAB-MT shall transmit uplink signal at least in all uplink slots configured for CSI transmission according to the configured periodic CSI reporting on the PCell.

The rate of correct events observed during repeated tests shall be at least 90%.

### G.2.3.1.7 Radio Link Monitoring Out-of-sync Test for FR2-1 PCell configured with CSI-RS-based RLM in non-DRX mode

#### G.2.3.1.7.1 Test Purpose and Environment

The purpose of this test is to verify that the IAB-MT properly detects the out of sync for the purpose of monitoring downlink CSI-RS based radio link quality of the PCell. This test will partly verify the FR2-1 PCell CSI-RS Out-of-sync radio link monitoring requirements in clause 12.3.1.3. This test case is applicable only for local area IAB-MT and for IAB type 2-0.

The test parameters are given in Tables G.2.3.1.7.1-1, G.2.3.1.7.1-2 and G.2.3.1.7.1-3 below. There is one cell, cell 1 which is the PCell, in the test. The test consists of three successive time periods, with time duration of T1, T2 and T3 respectively. Figure G.2.3.1.7.1-1 shows the variation of the downlink SNR in the PCell to emulate out-of-sync and in-sync states. Prior to the start of the time duration T1, the IAB-MT shall be fully synchronized to cell 1. The IAB-MT shall be configured for periodic CSI reporting with a reporting periodicity of 10 ms. In the test, SSB0 and SSB1 are configured as BFD-RS.

**Table G.2.3.1.7.1-1: Supported test configurations for FR2-1 PCell**

Configuration	Description
1	TDD duplex mode, 120 kHz SSB SCS, 100 MHz bandwidth

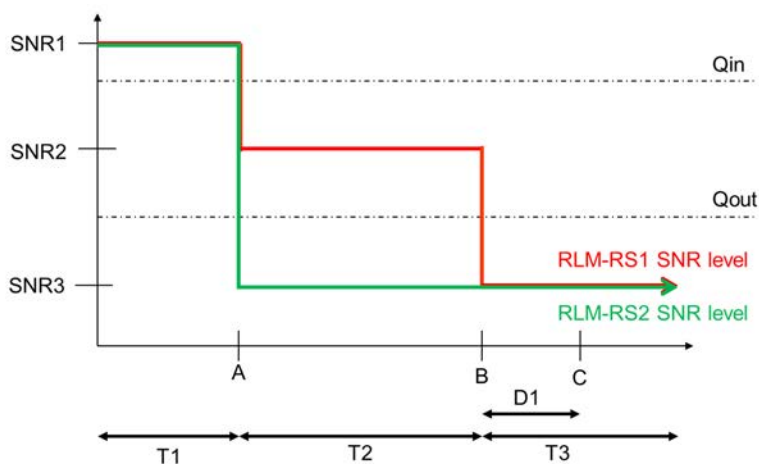

**Table G.2.3.1.7.1-2: General test parameters for FR2-1 PCell for CSI-RS out-of-sync testing in non-DRX**

Parameter		Unit	IAB-MT
			Test 1
Active PCell			Cell 1
RF Channel Number			1
Duplex mode	Config 1		TDD
TDD Configuration	Config 1		TDDConf.3.1
DL initial BWP configuration	Config 1		DLBWP.0.1
DL dedicated BWP configuration	Config 1		DLBWP.1.1
UL initial BWP configuration	Config 1		ULBWP.0.1
UL dedicated BWP configuration	Config 1		ULBWP.1.1
CORESET Reference Channel	Config 1		CCR.3.1 TDD CCR.3.3 TDD
SSB Configuration	Config 1		SSB.1 FR2-1
SMTC Configuration	Config 1		SMTC.1
PDSCH/PDCCH subcarrier spacing	Config 1		120 KHz
CSI-RS for RLM	Config 1		Resource #4 in TRS.2.1 TDD Resource #4 in TRS.2.2 TDD
TRS configuration			TRS.2.1 TDD TRS.2.2 TDD
TCI configuration for PDCCH#1/PDSCH			TCI.State.2
TCI configuration for PDCCH#2			TCI.State.3
OCNG parameters			OP.1
CP length			Normal
Out of sync transmission parameters	DCI format		1-0
	Number of Control OFDM symbols		2
	Aggregation level	CCE	8
	Ratio of hypothetical PDCCH RE energy to average CSI-RS RE energy	dB	4
	Ratio of hypothetical PDCCH DMRS energy to average CSI-RS RE energy	dB	4
	DMRS precoder granularity		REG bundle size
	REG bundle size		6
Layer 3 filtering			<i>Enabled</i>
T310 timer		ms	0
T311 timer		ms	1000
N310			1
N311			1
CSI-RS for CSI reporting	Config 1		CSI-RS.3.1 TDD
T1		s	0.2
T2		s	0.35
T3		s	0.35
D1		s	0.31
Note 1: IAB-MT-specific PDCCH is not transmitted after T1 starts.			

**Table G.2.3.1.7.1-3: Cell specific test parameters for FR2-1 for CSI-RS out-of-sync radio link monitoring in non-DRX**

Parameter		Unit	Test 1					
			T1	T2	T3	T1	T2	T3
AoA setup			AoA setup as defined in clause G.1.8					
			AoA1			AoA2		
Assumption for IAB-MT beams <sup>Note 8</sup>			Rough			Rough		
PDCCH_beta		dB	4			Not sent		
PDCCH_DMRS_beta		dB	4					
PBCH_beta		dB	0					
PSS_beta		dB						
SSS_beta		dB						
PDSCH_beta		dB						
OCNG_beta		dB						
SNR on RLM-RS1	Config 1	dB	2 <sup>Note 9</sup>	-6 <sup>Note 9</sup>	-15			
SNR on RLM-RS2	Config 1		Not sent			2 <sup>Note 9</sup>	-14	-15
SNR on other channels and signals	Config 1	dB	2 <sup>Note 9</sup>			N/A		
$N_{oc}$	Config 1	dBm/15kHz	-92.1			-92.1		
Propagation condition			TDL-C 300ns 100Hz			TDL-C 300ns 100Hz		
Note 1: OCNG shall be used such that the resources in Cell 1 are fully allocated and a constant total transmitted power spectral density is achieved for all OFDM symbols. Note 2: The uplink resources for CSI reporting are assigned to the IAB-MT prior to the start of time period T1. Note 3: NZP CSI-RS resource set configuration for CSI reporting are assigned to the IAB-MT prior to the start of time period T1. Note 4: The timers and layer 3 filtering related parameters are configured prior to the start of time period T1. Note 5: The signal contains PDCCH for IAB-MTs other than the device under test as part of OCNG. Note 6: SNR levels correspond to the signal to noise ratio over the SSS REs. Note 7: The SNR in time periods T1, T2 and T3 is denoted as SNR1, SNR2 and SNR3 respectively in figure G.2.3.1.7.1-1. Note 8: Information about types of IAB-MT beam does not limit IAB-MT implementation or test system implementation. Note 9: This IAB-MT allows up to 1dB degradation from applied SNR to IAB-MT baseband								



**Figure G.2.3.1.7.1-1: SNR variation for CSI-RS out-of-sync testing**

**G.2.3.1.7.2 Test Requirements**

The IAB-MT behaviour during time durations T1, T2, and T3 shall be as follows:

During time durations T1, T2 and T3, the IAB-MT shall transmit uplink signal at least in all subframes configured for CSI transmission on Cell 1.

During the period from time point A to time point B the IAB-MT shall transmit uplink signal in Cell 1 at least in all uplink slots configured for CSI transmission according to the configured periodic CSI reporting for Cell 1.

The IAB-MT shall stop transmitting uplink signal in Cell 1 no later than time point C ( $D_1$  second after the start of the time duration T3) on the PCell.

The rate of correct events observed during repeated tests shall be at least 90%.

### G.2.3.1.8 Radio Link Monitoring In-sync Test for FR2-1 PCell configured with CSI-RS-based RLM in non-DRX mode

#### G.2.3.1.8.1 Test Purpose and Environment

The purpose of this test is to verify that the IAB-MT properly detects the in sync for the purpose of monitoring downlink CSI-RS based radio link quality of the PCell. This test will partly verify the FR2-1 PCell CSI-RS In-sync radio link monitoring requirements in clause 12.3.1.3. This test case is applicable only for local area IAB-MT and for IAB type 2-O.

The test parameters are given in Tables G.2.3.1.8.1-1, G.2.3.1.8.1-2 and G.2.3.1.8.1-3 below. There is one cells, cell 1 which is the PCell, in the test. The test consists of five successive time periods, with time duration of T1, T2, T3, T4 and T5 respectively. Figure G.2.3.1.8.1-1 shows the variation of the downlink SNR in the PCell to emulate out-of-sync and in-sync states. Prior to the start of the time duration T1, the IAB-MT shall be fully synchronized to cell 1. The IAB-MT shall be configured for periodic CSI reporting with a reporting periodicity of 10 ms. In the test, SSB0 and SSB1 are configured as BFD-RS.

**Table G.2.3.1.8.1-1: Supported test configurations for FR2-1 PCell**

Configuration	Description
1	TDD duplex mode, 120 kHz SSB SCS, 100 MHz bandwidth

Table G.2.3.1.8.1-2: General test parameters for FR2-1 PCell for CSI-RS in-sync testing in non-DRX

Parameter		Unit	IAB-MT
			Test 1
Active PCell			Cell 1
RF Channel Number			1
Duplex mode	Config 1		TDD
TDD Configuration	Config 1		TDDConf.3.1
DL initial BWP configuration	Config 1		DLBWP.0.1
DL dedicated BWP configuration	Config 1		DLBWP.1.1
UL initial BWP configuration	Config 1		ULBWP.0.1
UL dedicated BWP configuration	Config 1		ULBWP.1.1
CORESET Reference Channel	Config 1		CCR.3.1 TDD CCR.3.3 TDD
SSB Configuration	Config 1		SSB.1 FR2-1
SMTC Configuration	Config 1		SMTC.1
PDSCH/PDCCH subcarrier spacing	Config 1		120 KHz
CSI-RS for RLM	Config 1		Resource #4 in TRS.2.1 TDD Resource #4 in TRS.2.2 TDD
TRS configuration			TRS.2.1 TDD TRS.2.2 TDD
TCI configuration for PDCCH#1/PDSCH			TCI.State.2
TCI configuration for PDCCH#2			TCI.State.3
OCNG parameters			OP.1
CP length			Normal
Out of sync transmission parameters	DCI format		1-0
	Number of Control OFDM symbols		2
	Aggregation level	CCE	8
	Ratio of hypothetical PDCCH RE energy to average CSI-RS RE energy	dB	4
	Ratio of hypothetical PDCCH DMRS energy to average CSI-RS RE energy	dB	4
	DMRS precoder granularity		REG bundle size
	REG bundle size		6
In sync transmission parameters	DCI format		1-0
	Number of Control OFDM symbols		2
	Aggregation level	CCE	4
	Ratio of hypothetical PDCCH RE energy to average CSI-RS RE energy	dB	0
	Ratio of hypothetical PDCCH DMRS energy to average CSI-RS RE energy	dB	0
	DMRS precoder granularity		REG bundle size
	REG bundle size		6
Layer 3 filtering			<i>Enabled</i>
T310 timer		ms	1000
T311 timer		ms	1000
N310			1
N311			1
CSI-RS for CSI reporting	Config 1		CSI-RS.3.1 TDD
T1		s	0.2
T2		s	0.2
T3		s	0.24
T4		s	0.2
T5		s	0.88
D1		s	0.84
Note 1: IAB-MT-specific PDCCH is not transmitted after T1 starts.			

**Table G.2.3.1.8.1-3: Cell specific test parameters for FR2-1 for CSI-RS in-sync radio link monitoring in non-DRX**

Parameter		Unit	Test 1									
			T1	T2	T3	T4	T5	T1	T2	T3	T4	T5
AoA setup			AoA setup as defined in clause G.1.8									
Assumption for IAB-MT beams <sup>Note 8</sup>			AoA1					AoA2				
			Rough					Rough				
PDCCH_beta		dB	4					Not sent				
PDCCH_DMRS_beta		dB	4									
PBCH_beta		dB	0									
PSS_beta		dB										
SSS_beta		dB										
PDSCH_beta		dB										
OCNG_beta		dB										
SNR on RLM-RS1	Config 1	dB	2 <sup>Note 9</sup>	-6 <sup>Note 9</sup>	-15	-4.5	2 <sup>Note 9</sup>					
SNR on RLM-RS2	Config 1		Not sent					2 <sup>Note 9</sup>	-14	-15	-15	-14
SNR on other channels and signals	Config 1	dB	2 <sup>Note 10</sup>					N/A				
$N_{oc}$	Config 1	dBm/15KHz	-92.1					-92.1				
Propagation condition			TDL-C 300ns 100Hz					TDL-C 300ns 100Hz				
<p>Note 1: OCNG shall be used such that the resources in Cell 1 are fully allocated and a constant total transmitted power spectral density is achieved for all OFDM symbols.</p> <p>Note 2: The uplink resources for CSI reporting are assigned to the IAB-MT prior to the start of time period T1.</p> <p>Note 3: NZP CSI-RS resource set configuration for CSI reporting are assigned to the IAB-MT prior to the start of time period T1.</p> <p>Note 4: The timers and layer 3 filtering related parameters are configured prior to the start of time period T1.</p> <p>Note 5: The signal contains PDCCH for IAB-MTs other than the device under test as part of OCNG.</p> <p>Note 6: SNR levels correspond to the signal to noise ratio over the SSS REs.</p> <p>Note 7: The SNR in time periods T1, T2, T3, T4 and T5 is denoted as SNR1, SNR2, SNR3, SNR4 and SNR5 respectively in figure G.2.3.1.8.1-1.</p> <p>Note 8: Information about types of IAB-MT beam does not limit IAB-MT implementation or test system implementation.</p> <p>Note 9: This IAB-MT allows up to 1dB degradation from applied SNR to IAB-MT baseband.</p>												

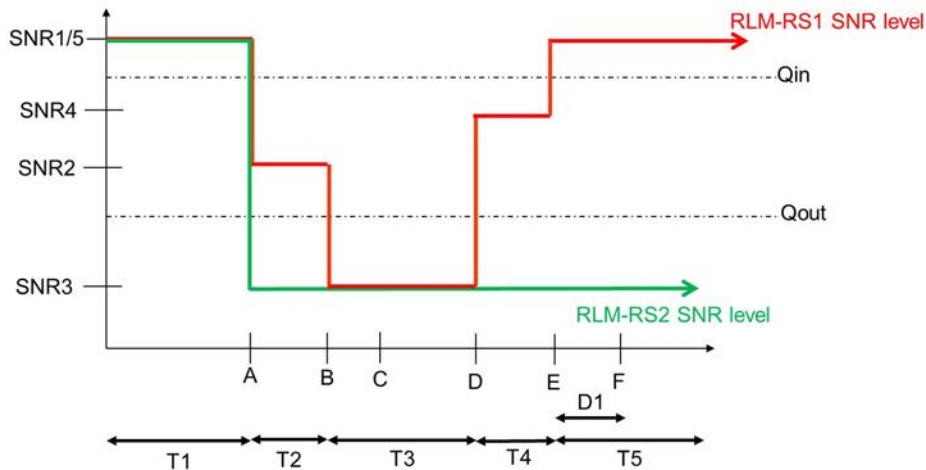

**Figure G.2.3.1.8.1-1: SNR variation for CSI-RS in-sync testing**

**G.2.3.1.8.2 Test Requirements**

The IAB-MT behaviour in each test during time durations T1, T2, T3, T4 and T5 shall be as follows:

During the period from time point A to time point F (D1 second after the start of time duration T5) the IAB-MT shall transmit uplink signal at least in all uplink slots configured for CSI transmission according to the configured periodic CSI reporting on the PCell.

The rate of correct events observed during repeated tests shall be at least 90%.

## G.2.3.2 Beam Failure Detection and Link Recovery Procedure

### G.2.3.2.1 Beam Failure Detection and Link Recovery Test for FR1 PCell configured with SSB-based BFD and LR

#### G.2.3.2.1.1 Test Purpose and Environment

The purpose of this test is to verify that the IAB-MT properly detects SSB-based beam failure in the set  $q_0$  configured for a serving cell and that the IAB-MT performs correct SSB-based link recovery based on beam candidate set  $q_1$ . The purpose is to test the downlink monitoring for beam failure detection within the IAB-MT's active DL BWP, during the evaluation period, and link recovery. This test will partly verify the SSB based beam failure detection and link recovery for an FR1 serving cell requirements in clause 12.3.2.

The test parameters are given in Tables G.2.3.2.1.1-1, G.2.3.2.1.1-2 and G.2.3.2.1.1-3 below. There is one cell, cell 1 which is the active cell, in the test. The test consists of five successive time periods, with time duration of T1, T2, T3, T4 and T5 respectively. Figure G.2.3.2.1.1-1 shows the variation of the downlink SNR of the SSB in set  $q_0$  in the active cell to emulate SSB based beam failure. Figure G.2.3.2.1.1-1 additionally shows the variation of the downlink L1-RSRP of the SSB in set  $q_1$  of the candidate beam used for link recovery. Prior to the start of the time duration T1, the IAB-MT shall be fully synchronized to cell 1. The IAB-MT shall be configured for periodic CSI reporting with a reporting periodicity of 2 ms. The IAB-MT is configured to perform inter-frequency measurements using GP ID #0 (40ms) in test 1.

**Table G.2.3.2.1.1-1: Supported test configurations for FR1 PCell**

Configuration	Description
1	TDD duplex mode, 15 kHz SSB SCS, 10 MHz bandwidth
2	TDD duplex mode, 30 kHz SSB SCS, 40 MHz bandwidth
Note:	The IAB-MT is only required to pass in one of the supported test configurations in FR1

**Table G.2.3.2.1.1-2: General test parameters for FR1 PCell for SSB-based beam failure detection and link recovery testing**

Parameter		Unit	Value	Comment
			Test 1	
Active PSCell			Cell 1	
RF Channel Number			1	
Duplex mode	Config 1, 2		TDD	
BWchannel	Config 1	MHz	10: NRB,c = 52	
	Config 2		40: NRB,c = 106	
DL initial BWP configuration	Config 1, 2		DLBWP.0.1	
DL dedicated BWP configuration	Config 1, 2		DLBWP.1.1	
UL initial BWP configuration	Config 1, 2		ULBWP.0.1	
UL dedicated BWP configuration	Config 1, 2		ULBWP.1.1	
CORESET Reference Channel	Config 1		CR.1.1 TDD	
	Config 2		CR.2.1 TDD	
SSB Configuration	Config 1		SSB.3 FR1	
	Config 2		SSB.4 FR1	
SMTC Configuration	Config 1		SMTC.1	
	Config 2		SMTC.1	
PDSCH/PDCCH subcarrier spacing	Config 1		15 KHz	
	Config 2		30 KHz	
PRACH Configuration	Config 1		Table G.X	
	Config 2		Table G.X	
SSB Index assigned as BFD RS ( $q_0$ )			0	
SSB Index assigned as CBD RS ( $q_1$ )			1	
OCNG parameters			OP.1	
CP length			Normal	
Correlation Matrix and Antenna Configuration			2x2 Low	
Beam failure detection transmission parameters	DCI format		1-0	
	Number of Control OFDM symbols		2	
	Aggregation level	CCE	8	
	Ratio of hypothetical PDCCH RE energy to average CSI-RS RE energy	dB	0	
	Ratio of hypothetical PDCCH DMRS energy to average CSI-RS RE energy	dB	0	
	DMRS precoder granularity		REG bundle size	
	REG bundle size		6	
rlmInSyncOutOfSyncThreshold			absent	When the field is absent, the IAB-MT applies the value 0. (Table 8.1.1-1 of TS 38.133).
rsrp-ThresholdSSB	Config 1	dBm/SC S kHz	-98	Threshold used for $Q_{in\_LR\_SSB}$
	Config 2		-95	
powerControlOffsetSS			db0	Used for deriving rsrp-ThresholdCSI-RS
beamFailureInstanceMaxCount			n1	see clause 5.17 of TS 38.321 [14]
beamFailureDetectionTimer			pbfd4	see clause 5.17 of TS 38.321 [14]
CSI-RS configuration for CSI reporting	Config 1		CSI-RS.1.1 TDD	
	Config 2		CSI-RS.2.1 TDD	
CSI-RS for tracking	Config 1		TRS.1.1 TDD	
	Config 2		TRS.1.2 TDD	
SSB Index assigned as RLM RS		0, 1		
T310 Timer	ms	1000		
N310		2		



T1	s	0.2	During this time the the IAB-MT shall be fully synchronized to cell 1
T2	s	0.37	
T3	s	0.24	
T4	s	0	
T5	s	0.17	
D1	s	0.13	
Note 1: All configurations are assigned to the IAB-MT prior to the start of time period T1.			
Note 2: IAB-MT-specific PDCCH is not transmitted after T1 starts.			

**Table G.2.3.2.1.1-3: Cell specific test parameters for FR1 PCell for SSB-based beam failure detection and link recovery testing**

Parameter		Unit	Test 1				
			T1	T2	T3	T4	T5
EPRE ratio of PDCCH DMRS to SSS		dB	0				
EPRE ratio of PDCCH to PDCCH DMRS							
EPRE ratio of PBCH DMRS to SSS							
EPRE ratio of PBCH to PBCH DMRS							
EPRE ratio of PSS to SSS							
EPRE ratio of PDSCH DMRS to SSS							
EPRE ratio of PDSCH to PDSCH DMRS							
EPRE ratio of OCNG DMRS to SSS							
EPRE ratio of OCNG to OCNG DMRS							
SNR_SSB of set $q_0$	Config 1	dB	5	-3	-12	-12	-12
	Config 2		5	-3	-12	-12	-12
SNR_SSB of set $q_1$	Config 1	dB	-10	-10	10	10	10
	Config 2		-10	-10	10	10	10
SSB_RP of set $q_1$	Config 1	dBm/S CS kHz	-108	-108	-88	-88	-88
	Config 2		-105	-105	-85	-85	-85
$N_{oc}$	Config 1	dBm/15 KHz	-98				
	Config 2		-98				
Propagation condition			TDL-C 300ns 100Hz				
Note 1: OCNG shall be used such that the resources in Cell 1 are fully allocated and a constant total transmitted power spectral density is achieved for all OFDM symbols.							
Note 2: The uplink resources for CSI reporting are assigned to the IAB-MT prior to the start of time period T1.							
Note 3: NZP CSI-RS resource set configuration for CSI reporting are assigned to the IAB-MT prior to the start of time period T1.							
Note 4: Void.							
Note 5: The timers and layer 3 filtering related parameters are configured prior to the start of time period T1.							
Note 6: The signal contains PDCCH for IAB-MTs other than the device under test as part of OCNG.							
Note 7: SNR levels correspond to the signal to noise ratio over the SSS REs.							
Note 8: The SNR in time periods T1, T2, T3, T4 and T5 is denoted as SNR1, SNR2 and SNR3 respectively in figure G.2.3.2.1.1-1.							
Note 9: The SNR values are specified for testing a IAB-MT which supports 2RX on at least one band. For testing of a IAB-MT which supports 4RX on all bands, the SNR during T3 is modified as specified in clause G.1.3.							

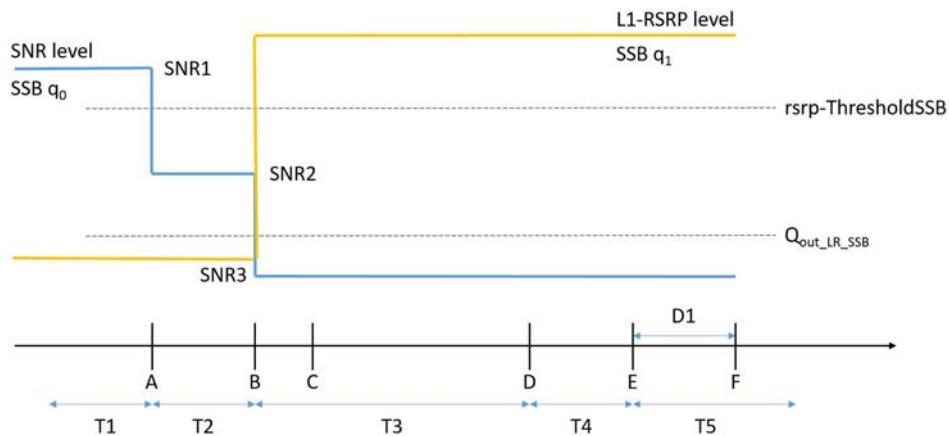

**Figure G.2.3.2.1.1-1: SNR and L1-RSRP variation SSB for SSB-based beam failure detection and link recovery testing**

### G.2.3.2.1.2 Test Requirements

The IAB-MT behaviour during time durations T1, T2, T3, T4 and T5 shall be as follows:

During the time duration T1 and T2, the IAB-MT shall transmit uplink signal at least in all subframes configured for CSI transmission on Cell 1.

During the period from time point A to time point B the IAB-MT shall transmit uplink signal in Cell 1 in all uplink slots configured for CSI transmission according to the configured periodic CSI reporting for Cell 1.

During T3 the IAB-MT shall detect beam failure and initiate link recovery. During T4 and T5 the IAB-MT measures and evaluate beam candidate from beam candidate set  $q_1$ .

No later than time point F occurring no later than  $D1 = 120 + 10$  ms after the start of T5, the IAB-MT shall transmit preamble on a beam associated with the candidate beam set  $q_1$ . The IAB-MT shall not transmit preamble on a beam associated with the candidate beam set  $q_1$  earlier than time point B.

Test is concluded once the test equipment has received the initial preamble transmission from the IAB-MT. The rate of correct events observed during repeated tests shall be at least 90%.

### G.2.3.2.2 Beam Failure Detection and Link Recovery Test for FR2-1 PCell configured with SSB-based BFD and LR

#### G.2.3.2.2.1 Test Purpose and Environment

The purpose of this test is to verify that the IAB-MT properly detects SSB-based beam failure in the set  $q_0$  configured for a serving cell and that the IAB-MT performs correct SSB-based link recovery based on beam candidate set  $q_1$ . The purpose is to test the downlink monitoring for beam failure detection within the IAB-MT active DL BWP, during the evaluation period, and link recovery, when no DRX is used. This test will partly verify the SSB based beam failure detection and link recovery for an FR2-1 serving cell requirements in clause 12.3.2.2.

The test parameters are given in Tables G.2.3.2.2.1-1, G.2.3.2.2.1-2 and G.2.3.2.2.1-3 below. There is one cell, cell 1 which is the active cell, in the test. The test consists of five successive time periods, with time duration of T1, T2, T3, T4 and T5 respectively. Figure G.2.3.2.X.1-1 shows the variation of the downlink SNR of the SSB in set  $q_0$  in the active cell to emulate SSB based beam failure. Figure G.2.3.2.2.1-1 additionally shows the variation of the downlink L1-RSRP of the SSB in set  $q_1$  of the candidate beam used for link recovery. Prior to the start of the time duration T1, the IAB-MT shall be fully synchronized to cell 1. The IAB-MT shall be configured for periodic CSI reporting with a reporting periodicity of 2 ms. In the test, DRX configuration is not enabled.

**Table G.2.3.2.2.1-1: Supported test configurations for FR2-1 PCell**

<b>Configuration</b>	<b>Description</b>
1	TDD duplex mode, 120 kHz SSB SCS, 100 MHz bandwidth
2	TDD duplex mode, 240 kHz SSB SCS, 100 MHz bandwidth
Note:	The IAB-MT is only required to pass in one of the supported test configurations in FR2-1

**Table G.2.3.2.2.1-2: General test parameters for FR2-1 PCell for SSB-based beam failure detection and link recovery testing**

Parameter		Unit	Value	Comment
			Test 1	
Active PCell			Cell 1	
RF Channel Number			1	
Duplex mode	Config 1, 2		TDD	
BW <sub>channel</sub>	Config 1, 2		100: N <sub>RB,c</sub> = 66	
DL initial BWP configuration	Config 1, 2		DLBWP.0.1	
DL dedicated BWP configuration	Config 1, 2		DLBWP.1.1	
UL initial BWP configuration	Config 1, 2		ULBWP.0.1	
UL dedicated BWP configuration	Config 1, 2		ULBWP.1.1	
CORESET Reference Channel	Config 1, 2		CR. 3.1 TDD	
SSB Configuration	Config 1		SSB.1 FR2-1	
	Config 2		SSB.2 FR2-1	
SMTC Configuration	Config 1, 2		SMTC.3	
PDSCH/PDCCH subcarrier spacing	Config 1, 2		120 KHz	
SSB index assigned as BFD RS (q <sub>0</sub> )			0	
SSB index assigned as CBD RS (q <sub>1</sub> )			1	
OCNG parameters			OP.1	
CP length			Normal	
Beam failure detection transmission parameters	DCI format		1-0	
	Number of Control OFDM symbols		2	
	Aggregation level	CCE	8	
	Ratio of hypothetical PDCCH RE energy to average CSI-RS RE energy	dB	0	
	Ratio of hypothetical PDCCH DMRS energy to average CSI-RS RE energy	dB	0	
	DMRS precoder granularity		REG bundle size	
	REG bundle size		6	
DRX			OFF	
rlmInSyncOutOfSyncThreshold			absent	When the field is absent, the IAB-MT applies the value 0. (Table 8.1.1-1 in TS 38.133 [6]).

rsrp-ThresholdSSB	Config 1	dBm/SSB SCS	-94.5	Threshold used for $Q_{in\_LR\_SSB}$
	Config 2		-91.5	
powerControlOffsetSS			db0	Used for deriving rsrp-ThresholdCSI-RS
beamFailureInstanceMaxCount			n1	see clause 5.17 of TS 38.321 [7]
beamFailureDetectionTimer			pbfd4	see clause 5.17 of TS 38.321 [7]
CSI-RS configuration for CSI reporting	Config 1, 2		CSI-RS.3.1 TDD	
TCI states			TCI.State.0	
CSI-RS for tracking	Config 1, 2		TRS.2.1 TDD	
SSB index assigned as RLM RS			0, 1	
T310 Timer		ms	1000	
N310			2	
T1		s	1	During this time the the IAB-MT shall be fully synchronized to cell 1
T2		s	2.61	
T3		s	1.64	
T4		s	0	
T5		s	1.01	
D1		s	0.97	
Note 1: All configurations are assigned to the IAB-MT prior to the start of time period T1.				
Note 2: IAB-MT-specific PDCCH is not transmitted after T1 starts.				

*Editor's note: An additional RS for RLM, different from BFD-RS at constant high SNR shall be configured as part of the test configuration.*

**Table G.2.3.2.2.1-3: Cell specific test parameters for FR2-1 PCell for SSB-based beam failure detection and link recovery testing**

Parameter		Unit	Test 1				
			T1	T2	T3	T4	T5
AoA setup			Setup 1 defined in G.1.18				
EPRE ratio of PDCCH DMRS to SSS		dB	0				
EPRE ratio of PDCCH to PDCCH DMRS		dB					
EPRE ratio of PBCH DMRS to SSS		dB					
EPRE ratio of PBCH to PBCH DMRS		dB					
EPRE ratio of PSS to SSS		dB					
EPRE ratio of PDSCH DMRS to SSS		dB					
EPRE ratio of PDSCH to PDSCH DMRS		dB					
EPRE ratio of OCNG DMRS to SSS		dB					
EPRE ratio of OCNG to OCNG DMRS		dB					
SNR_SSB of set $q_0$	Config 1	dB					
	Config 2		5	-3	-12	-12	-12
SNR_SSB of set $q_1$	Config 1	dB	0.2	0.2	20.2	20.2	20.2
	Config 2		0.2	0.2	20.2	20.2	20.2
SSB_RP of set $q_1$	Config 1	dBm/SSB	-104.5	-104.5	-84.5	-84.5	-84.5
	Config 2	SCS	-101.5	-101.5	-81.5	-81.5	-81.5
$N_{oc}$	Config 1	dBm/120 KHz	-104.7				
	Config 2		-104.7				
Propagation condition			TDL-A 30ns 75Hz				
<p>Note 1: OCNG shall be used such that the resources in Cell 1 are fully allocated and a constant total transmitted power spectral density is achieved for all OFDM symbols.</p> <p>Note 2: The uplink resources for CSI reporting are assigned to the IAB-MT prior to the start of time period T1.</p> <p>Note 3: NZP CSI-RS resource set configuration for CSI reporting are assigned to the IAB-MT prior to the start of time period T1.</p> <p>Note 4: Void</p> <p>Note 5: The timers and layer 3 filtering related parameters are configured prior to the start of time period T1.</p> <p>Note 6: The signal contains PDCCH for IAB-MTs other than the device under test as part of OCNG.</p> <p>Note 7: SNR levels correspond to the signal to noise ratio over the SSS REs.</p> <p>Note 8: The SNR in time periods T1, T2, T3, T4 and T5 is denoted as SNR1, SNR2 and SNR3 respectively in figure G.2.3.2.X.1-1.</p> <p>Note 9: The SNR values are specified for testing an IAB-MT which supports 2RX on at least one band. For testing of an IAB-MT which supports 4RX on all bands, the SNR during T3 is modified as specified in clause G.1.3. 1</p>							

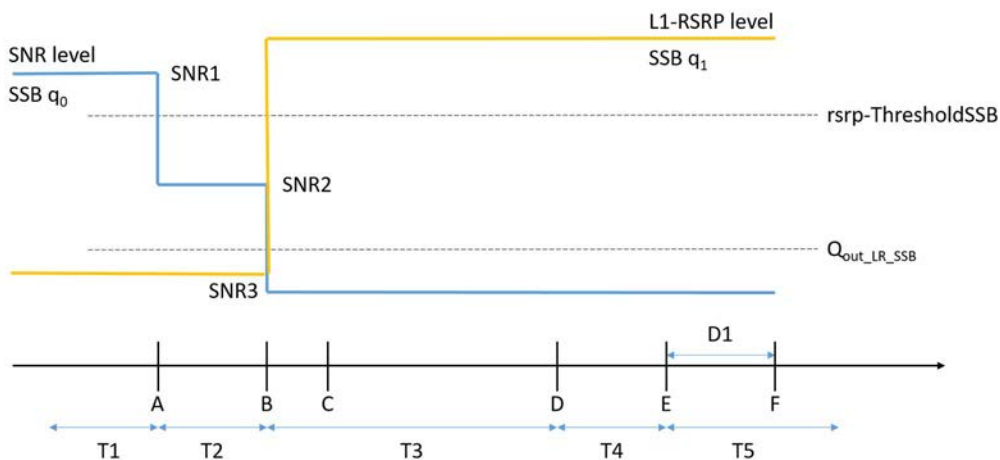

**Figure G.2.3.2.2.1-1: SNR and L1-RSRP variation SSB for SSB-based beam failure detection and link recovery testing in non-DRX mode**

### G.2.3.2.2.2 Test Requirements

The IAB-MT behaviour during time durations T1, T2, T3, T4 and T5 shall be as follows:

During the time duration T1 and T2, the IAB-MT shall transmit uplink signal at least in all subframes configured for CSI transmission on Cell 1.

During the period from time point A to time point B the IAB-MT shall transmit uplink signal in Cell 1 in all uplink slots configured for CSI transmission according to the configured periodic CSI reporting for Cell 1.

During T3 the IAB-MT shall detect beam failure and initiate link recovery. During T4 and T5 the IAB-MT measures and evaluate beam candidate from beam candidate set  $q_1$ .

No later than time point F occurring no later than  $D1 = 560+650$  ms after the start of T5, the IAB-MT shall transmit preamble on a beam associated with the candidate beam set  $q_1$ . The IAB-MT shall not transmit preamble on a beam associated with the candidate beam set  $q_1$  earlier than time point B.

Test is concluded once the test equipment has received the initial preamble transmission from the IAB-MT. The rate of correct events observed during repeated tests shall be at least 90%.

### G.2.3.2.3 Beam Failure Detection and Link Recovery Test for FR1 PCell configured with CSI-RS-based BFD and LR

#### G.2.3.2.3.1 Test Purpose and Environment

The purpose of this test is to verify that the IAB-MT properly detects CSI-RS-based beam failure in the set  $q_0$  configured for a serving cell and that the IAB-MT performs correct CSI-RS-based link recovery based on beam candidate set  $q_1$ . The purpose is to test the downlink monitoring for beam failure detection within the IAB-MTs active DL BWP, during the evaluation period, and link recovery. This test will partly verify the CSI-RS based beam failure detection and link recovery for an FR1 serving cell requirements in clause 12.3.2.

The test parameters are given in Tables G.2.3.2.3.1-1, G.2.3.2.3.1-2 and G.2.3.2.3.1-3 below. There is one cell, cell 1 which is the active cell, in the test. The test consists of five successive time periods, with time duration of T1, T2, T3, T4 and T5 respectively. Figure G.2.3.2.3.1-1 shows the variation of the downlink SNR of the CSI-RS in set  $q_0$  in the active cell to emulate CSI-RS based beam failure. Figure G.2.3.2.3.1-1 additionally shows the variation of the downlink L1-RSRP of the CSI-RS in set  $q_1$  of the candidate beam used for link recovery. Prior to the start of the time duration T1, the IAB-MT shall be fully synchronized to cell 1. The IAB-MT shall be configured for periodic CSI reporting with a reporting periodicity of [2] ms.

**Table G.2.3.2.3.1-1: Supported test configurations for FR1 PCell**

Configuration	Description
1	TDD duplex mode, 15 kHz SSB SCS, 10 MHz bandwidth
2	TDD duplex mode, 30 kHz SSB SCS, 40 MHz bandwidth
Note:	The IAB-MT is only required to pass in one of the supported test configurations in FR1



**Table G.2.3.2.3.1-2: General test parameters for FR1 PCell for CSI-RS-based beam failure detection and link recovery testing**

Parameter		Unit	Value	Comment
			Test 1	
Active PCell			Cell 1	
RF Channel Number			1	
Duplex mode	Config 1, 2		TDD	
CORESET Reference Channel	Config 1		CR.1.1 TDD	
	Config 2		CR.2.1 TDD	
SSB Configuration	Config 1		SSB.1 FR1	
	Config 2		SSB.2 FR1	
SMTC Configuration	Config 1		SMTC.1	G.1.6
	Config 2		SMTC.1	
PDSCH/PDCCH subcarrier spacing	Config 1		15 KHz	
	Config 2		30 KHz	
csi-RS-Index assigned as beam failure detection RS in set $q_0$			0	
OCNG parameters			OP.1	G.1.2.1
CP length			Normal	
Correlation Matrix and Antenna Configuration			2x2 Low	
Beam failure detection transmission parameters	DCI format		1-0	
	Number of Control OFDM symbols		2	
	Aggregation level	CCE	8	
	Ratio of hypothetical PDCCH RE energy to average CSI-RS RE energy	dB	0	
	Ratio of hypothetical PDCCH DMRS energy to average CSI-RS RE energy	dB	0	
	DMRS precoder granularity		REG bundle size	
	REG bundle size		6	
csi-RS-Index assigned as candidate beam detection RS in set $q_1$			1	N
rimInSyncOutOfSyncThreshold			absent	When the field is absent, the IAB-MT applies the value 0. (Table 8.1.1-1of TS 38.133).
rsrp-ThresholdSSB	Config 1	dBm/S CS kHz	-98	Threshold used for $Q_{in\_LR\_SSB}$
	Config 2		-95	
powerControlOffsetSS			db0	Used for deriving rsrp-ThresholdCSI-RS
beamFailureInstanceMaxCount			n1	see clause 5.17 of TS 38.321 [14]
beamFailureDetectionTimer			pbfd4	see clause 5.17 of TS 38.321 [14]
CSI-RS configuration for $q_0$ and $q_1$	Config 1		CSI-RS.1.2 TDD	
	Config 2		CSI-RS.2.2 TDD	
CSI-RS configuration for CSI reporting	Config 1		CSI-RS.1.1 TDD	
	Config 2		CSI-RS.2.1 TDD	
TRS configuration	Config 1		TRS.1.1 TDD	
	Config 2		TRS.1.2 TDD	
CSI-RS-Index assigned as RLM RS	Config 1		CSI-RS.1.2 TDD	
	Config 2		CSI-RS.2.2 TDD	
T310 Timer		ms	1000	
N310			2	
T1		s	0.2	During this time the the IAB-MT shall be fully synchronized to cell 1
T2		s	0.18	
T3		s	0.14	
T4		s	0	
T5		s	0.08	
D1		s	0.04	

Note 1: IAB-MT-specific PDCCH is not transmitted after T1 starts.
---

**Table G.2.3.2.3.1-3: Cell specific test parameters for FR1 PCell for CSI-RS-based beam failure detection and link recovery testing**

Parameter		Unit	Test 1				
			T1	T2	T3	T4	T5
EPRE ratio of PDCCH DMRS to SSS		dB	0				
EPRE ratio of PDCCH to PDCCH DMRS							
EPRE ratio of PBCH DMRS to SSS							
EPRE ratio of PBCH to PBCH DMRS							
EPRE ratio of PSS to SSS							
EPRE ratio of PDSCH DMRS to SSS							
EPRE ratio of PDSCH to PDSCH DMRS							
EPRE ratio of OCNG DMRS to SSS							
EPRE ratio of OCNG to OCNG DMRS							
SNR_CSI-RS of set $q_0$	Config 1	dB	5	-3	-12	-12	-12
	Config 2		5	-3	-12	-12	-12
SNR_CSI-RS of set $q_1$	Config 1	dB	-10	-10	10	10	10
	Config 2		-10	-10	10	10	10
CSI-RS_RP of set $q_1$	Config 1	dBm/S CS kHz	-108	-108	-88	-88	-88
	Config 2		-105	-105	-85	-85	-85
$N_{oc}$	Config 1	dBm/15 KHz	-98				
	Config 2		-98				
Propagation condition			TDL-C 300ns 100Hz				
<p>Note 1: OCNG shall be used such that the resources in Cell 1 are fully allocated and a constant total transmitted power spectral density is achieved for all OFDM symbols.</p> <p>Note 2: The uplink resources for CSI reporting are assigned to the IAB-MT prior to the start of time period T1.</p> <p>Note 3: NZP CSI-RS resource set configuration for CSI reporting are assigned to the IAB-MT prior to the start of time period T1.</p> <p>Note 4: Void</p> <p>Note 5: The timers and layer 3 filtering related parameters are configured prior to the start of time period T1.</p> <p>Note 6: The signal contains PDCCH for IAB-MTs other than the device under test as part of OCNG.</p> <p>Note 7: SNR levels correspond to the signal to noise ratio over the REs carrying CSI-RS.</p> <p>Note 8: The SNR in time periods T1, T2, T3, T4 and T5 is denoted as SNR1, SNR2 and SNR3 respectively in figure G.2.3.2.2.1-1.</p> <p>Note 9: The SNR values are specified for testing a IAB-MT which supports 2RX on at least one band. For testing of a IAB-MT which supports 4RX on all bands, the SNR during T3 is modified as specified in clause G.1.3.</p>							

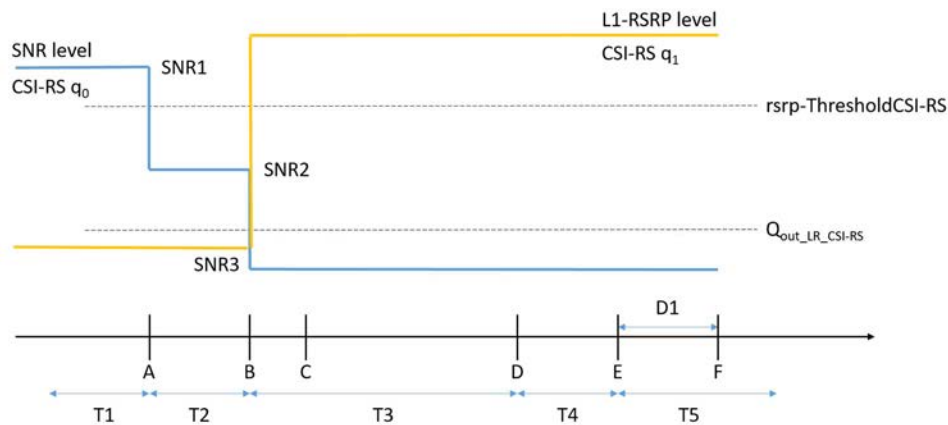

**Figure G.2.3.2.3.1-1: SNR and L1-RSRP variation for CSI-RS-based beam failure detection and link recovery testing**

#### G.2.3.2.3.2 Test Requirements

The IAB-MT behaviour during time durations T1, T2, T3, T4 and T5 shall be as follows:

During the time duration T1 and T2, the IAB-MT shall transmit uplink signal at least in all subframes configured for CSI transmission on Cell 1.

During the period from time point A to time point B the IAB-MT shall transmit uplink signal in Cell 1 in all uplink slots configured for CSI transmission according to the configured periodic CSI reporting for Cell 1.

During T3 the shall detect beam failure and initiate link recovery. During T4 and T5 the IAB-MT measures and evaluate beam candidate from beam candidate set  $q_1$ .

No later than time point F occurring no later than  $D1 = 30+10$  ms after the start of T5, the IAB-MT shall transmit preamble on a beam associated with the candidate beam set  $q_1$ . The IAB-MT shall not transmit preamble on a beam associated with the candidate beam set  $q_1$  earlier than time point B.

Test is concluded once the test equipment has received the initial preamble transmission from the IAB-MT. The rate of correct events observed during repeated tests shall be at least 90%.

#### G.2.3.2.4 Beam Failure Detection and Link Recovery Test for FR2-1 PCell configured with CSI-RS-based BFD and LR in non-DRX mode

##### G.2.3.2.4.1 Test Purpose and Environment

The purpose of this test is to verify that the IAB-MT properly detects CSI-RS-based beam failure in the set  $q_0$  configured for a serving cell and that the IAB-MT performs correct CSI-RS-based link recovery based on beam candidate set  $q_1$ . The purpose is to test the downlink monitoring for beam failure detection within the IAB-MT's active DL BWP, during the evaluation period, and link recovery, when no DRX is used. This test will partly verify the CSI-RS based beam failure detection and link recovery for an FR2-1 serving cell requirements in clause 12.3.2.

The test parameters are given in Tables G.2.3.2.4.1-1, G.2.3.2.4.1-2, and G.2.3.2.4.1-3 below. There is one cell, cell 1 which is the active cell, in the test. The test consists of five successive time periods, with time duration of T1, T2, T3, T4 and T5 respectively. Figure G.2.3.2.4.1-1 shows the variation of the downlink SNR of the CSI-RS in set  $q_0$  in the active cell to emulate CSI-RS based beam failure. Figure G.2.3.2.4.1-1 additionally shows the variation of the downlink L1-RSRP of the CSI-RS in set  $q_1$  of the candidate beam used for link recovery. Prior to the start of the time duration T1, the IAB-MT shall be fully synchronized to cell 1. The IAB-MT shall be configured for periodic CSI reporting with a reporting periodicity of [2] ms. In the test, DRX configuration is not enabled.

**Table G.2.3.2.4.1-1: Supported test configurations for FR2-1 PCell**

<b>Configuration</b>	<b>Description</b>
1	TDD duplex mode, 120 kHz SSB SCS, 100 MHz bandwidth

**Table G.2.3.2.4.1-2: General test parameters for FR2 PCell for CSI-RS based beam failure detection and link recovery testing in non-DRX mode**

Parameter		Unit	Value	Comment
			Test 1	
Active PCell			Cell 1	
RF Channel Number			1	
Duplex mode	Config 1		TDD	
TDD Configuration	Config 1		TBD	
CORESET Reference Channel	Config 1		CR.3.1 TDD	G.1.1.2
SSB Configuration	Config 1		SSB.3 FR2-1	G.1.5
SMTC Configuration	Config 1		SMTC.3	G.1.6
PDSCH/PDCCH subcarrier spacing	Config 1		120KHz	
csi-RS-Index assigned as beam failure detection RS in set $q_0$			0	
TRS configuration			TRS.2.1 TDD	G.1.10.2
TCI configuration			TBD	
OCNG parameters			OP.1	G.1.2.1
CP length			Normal	
Beam failure detection transmission parameters	DCI format		1-0	
	Number of Control OFDM symbols		2	
	Aggregation level	CCE	8	
	Ratio of hypothetical PDCCH RE energy to average CSI-RS RE energy	dB	0	
	Ratio of hypothetical PDCCH DMRS energy to average CSI-RS RE energy	dB	0	
	DMRS precoder granularity		REG bundle size	
	REG bundle size		6	
DRX			OFF	
csi-RS-Index assigned as candidate beam detection RS in set $q_1$			1	
rlmInSyncOutOfSyncThreshold			absent	When the field is absent, the IAB-MT applies the value 0. (Table 8.1.1-1 in TS 38.133 [6]).
rsrp-ThresholdSSB		dBm/S CS kHz	-94.5	Threshold used for $Q_{in\_LR\_SSB}$
powerControlOffsetSS			db0	Used for deriving rsrp-ThresholdCSI-RS
beamFailureInstanceMaxCount			n1	see clause 5.17 of TS 38.321 [14]
beamFailureDetectionTimer			pbfd4	see clause 5.17 of TS 38.321 [14]
CSI-RS configuration for $q_0$ and $q_1$	Config 1		CSI-RS.3.2 TDD	G.1.7.1
CSI-RS configuration for CSI reporting	Config 1		CSI-RS.3.1 TDD	G.1.7.1
csi-RS-Index assigned as RLM RS			0, 1	G.1.7.1
T310 Timer		ms	1000	
N310			2	
T1		s	0.2	During this time the the IAB-MT shall be fully synchronized to cell 1
T2		s	0.18	

T3	s	0.14	
T4	s	0	
T5	s	0.08	
D1	s	0.04	
Note 1: IAB-MT-specific PDCCH is not transmitted after T1 starts.			

**Table G.2.3.2.4.1-3: Cell specific test parameters for FR2-1 PCell for CSI-RS based beam failure detection and link recovery testing in non-DRX mode**

Parameter		Unit	Test 1				
			T1	T2	T3	T4	T5
AoA setup			Setup 1 defined in G.1.8				
EPRE ratio of PDCCH DMRS to SSS		dB	0				
EPRE ratio of PDCCH to PDCCH DMRS		dB					
EPRE ratio of PBCH DMRS to SSS		dB					
EPRE ratio of PBCH to PBCH DMRS		dB					
EPRE ratio of PSS to SSS		dB					
EPRE ratio of PDSCH DMRS to SSS		dB					
EPRE ratio of PDSCH to PDSCH DMRS		dB					
EPRE ratio of OCNG DMRS to SSS		dB					
EPRE ratio of OCNG to OCNG DMRS		dB					
SNR_CSI-RS of set q <sub>0</sub>	Config 1	dB	5	-3	-12	-12	-12
SNR_CSI-RS of set q <sub>1</sub>	Config 1	dB	0.2	0.2	20.2	20.2	20.2
CSI-RS_RP of set q <sub>1</sub>	Config 1	dBm/S CS kHz	-104.5	-104.5	-84.5	-84.5	-84.5
N <sub>oc</sub>	Config 1	dBm/15 KHz	-104.7				
Propagation condition			TDL-A 30ns 75Hz				
<p>Note 1: OCNG shall be used such that the resources in Cell 1 are fully allocated and a constant total transmitted power spectral density is achieved for all OFDM symbols.</p> <p>Note 2: The uplink resources for CSI reporting are assigned to the IAB-MT prior to the start of time period T1.</p> <p>Note 3: NZP CSI-RS resource set configuration for CSI reporting are assigned to the IAB-MT prior to the start of time period T1.</p> <p>Note 4: Void</p> <p>Note 5: The timers and layer 3 filtering related parameters are configured prior to the start of time period T1.</p> <p>Note 6: The signal contains PDCCH for UEs other than the device under test as part of OCNG.</p> <p>Note 7: SNR levels correspond to the signal to noise ratio over the REs carrying CSI-RS.</p> <p>Note 8: The SNR in time periods T1, T2, T3, T4 and T5 is denoted as SNR1, SNR2 and SNR3 respectively in figure G.2.3.2.x.1-1.</p> <p>Note 9: The SNR values are specified for testing an IAB-MT which supports 2RX on at least one band. For testing of an IAB-MT which supports 4RX on all bands, the SNR during T3 is modified as specified in clause G.1.3.2.</p>							



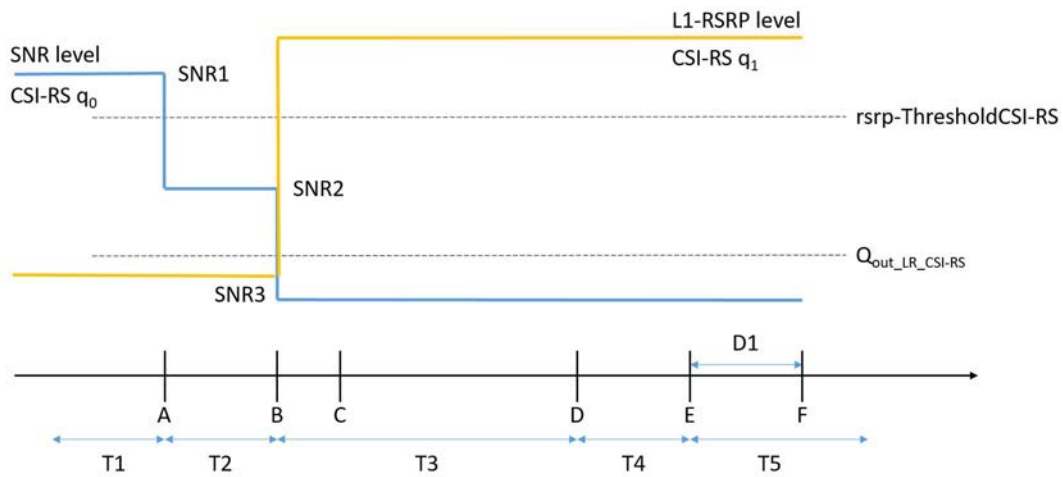

**Figure G.2.3.2.4.1-1: SNR and L1-RSRP variation for CSI-RS based beam failure detection and link recovery testing in non-DRX mode**

G.2.3.2.4.2 Test Requirements

The IAB-MT behaviour during time durations T1, T2, T3, T4 and T5 shall be as follows:

During the time duration T1 and T2, the IAB-MT shall transmit uplink signal at least in all subframes configured for CSI transmission on Cell 1.

During the period from time point A to time point B the IAB-MT shall transmit uplink signal in Cell 1 in all uplink slots configured for CSI transmission according to the configured periodic CSI reporting for Cell 1.

During T3 the shall detect beam failure and initiat link recovery. During T4 and T5 the IAB-MT measures and evaluate beam candidate from beam candidate set  $q_1$ .

No later than time point F occurring no later than  $D1 = 30 + 10$  ms after the start of T5, the IAB-MT shall transmit preamble on a beam associated with the candidate beam set  $q_1$ . The IAB-MT shall not transmit preamble on a beam associated with the candidate beam set  $q_1$  earlier than time point B.

Test is concluded once the test equipment has received the initial preamble transmission from the IAB-MT. The rate of correct events observed during repeated tests shall be at least 90%.

# Annex H (normative):

## Conditions for IAB-MT RRM requirements applicability for operating bands

### H.1 Conditions for RRC\_CONNECTED state mobility for IAB-MT

#### H.1.1 Introduction

In Annex H.1, the following conditions are specified:

- IAB-MT conditions which shall apply for IAB-MT RRC Connection Re-establishment requirements for NR intra-frequency cells in clause 12.1.1.1 and
- IAB-MT conditions which shall apply for IAB-MT RRC Connection Re-establishment requirements for NR inter-frequency cells in clause 12.1.1.1 and
- IAB-MT conditions which shall apply for IAB-MT RRC Connection Release with Redirection requirements for NR cells in clause 12.1.1.3.

#### H.1.1.1 Conditions for Measurements on NR Intra-frequency Cells for RRC Connection Re-establishment

This clause defines the following conditions in terms of SSB<sub>RP</sub> and SSB  $\hat{E}_s/I_{ot}$  for measurements on NR intra-frequency cells for RRC connection re-establishment:

- The conditions are defined in Table H.1.1.1-1 for FR1 NR cells for Wide Area IAB-MT and IAB Type 1-H.
- The conditions are defined in Table H.1.1.1-2 for FR1 NR cells for Local Area IAB-MT and IAB Type 1-H.
- The conditions are defined in Table H.1.1.1-3 for FR1 NR cells for Wide Area IAB-MT and IAB Type 1-O.
- The conditions are defined in Table H.1.1.1-4 for FR1 NR cells for Local Area IAB-MT and IAB Type 1-O.
- The conditions are defined in Table H.1.1.1-5 for FR2-1 NR cells for Local Area and Wide Area IAB-MT and IAB Type 2-O.

**Table H.1.1.1-1: Conditions for RRC connection re-establishment for intra-frequency cell for Wide Area IAB-MT and IAB Type 1-H**

IAB-MT channel bandwidth (MHz)	SSB sub-carrier spacing (kHz)	Side conditions	
		SSB $\hat{E}_s/I_{ot}$ (dB)	Minimum SSB <sub>RP</sub> (dBm)
10, 15	30	-6	$-107 - 10 \cdot \log_{10}(N_{PRB} \cdot 12)$
20, 25, 30, 40, 50, 60, 70, 80, 90, 100	30	-6	$-101.4 - 10 \cdot \log_{10}(N_{PRB} \cdot 12)$

NOTE 1:  $N_{PRB}$  is the number of PRBs within the IAB-MT channel bandwidth defined in section 5.3.2.

**Table H.1.1.1-2: Conditions for RRC connection re-establishment for intra-frequency cell for Local Area IAB-MT and IAB Type 1-H**

IAB-MT channel bandwidth (MHz)	SSB sub-carrier spacing (kHz)	Side conditions	
		SSB $\hat{E}_s/I_{ot}$ (dB)	Minimum SSB <sub>RP</sub> (dBm)
10, 15	30	-6	$-99 - 10 \cdot \log_{10}(N_{PRB} \cdot 12)$
20, 25, 30, 40, 50, 60, 70, 80, 90, 100	30	-6	$-92.5 - 10 \cdot \log_{10}(N_{PRB} \cdot 12)$

NOTE 1:  $N_{PRB}$  is the number of PRBs within the IAB-MT channel bandwidth defined in section 5.3.2.

**Table H.1.1.1-3: Conditions for RRC connection re-establishment for intra-frequency cell for Wide Area IAB-MT and IAB Type 1-O**

IAB-MT channel bandwidth (MHz)	SSB sub-carrier spacing (kHz)	Side conditions	
		SSB $\hat{E}_s/\text{lot}$ (dB)	Minimum SSB_RP (dBm)
10, 15	30	-6	$-107 - 10 \cdot \log_{10}(N_{\text{PRB}} \cdot 12) - \Delta_{\text{OTAREFSSENS}}$
20, 25, 30, 40, 50, 60, 70, 80, 90, 100	30	-6	$-101.4 - 10 \cdot \log_{10}(N_{\text{PRB}} \cdot 12) - \Delta_{\text{OTAREFSSENS}}$

NOTE 1:  $N_{\text{PRB}}$  is the number of PRBs within the IAB-IMT channel bandwidth defined in section 5.3.2.

**Table H.1.1.1-4: Conditions for RRC connection re-establishment for intra-frequency cell for Local Area IAB-MT and IAB Type 1-O**

IAB-MT channel bandwidth (MHz)	SSB sub-carrier spacing (kHz)	Side conditions	
		SSB $\hat{E}_s/\text{lot}$ (dB)	Minimum SSB_RP (dBm)
10, 15	30	-6	$-99 - 10 \cdot \log_{10}(N_{\text{PRB}} \cdot 12) - \Delta_{\text{OTAREFSSENS}}$
20, 25, 30, 40, 50, 60, 70, 80, 90, 100	30	-6	$-92.5 - 10 \cdot \log_{10}(N_{\text{PRB}} \cdot 12) - \Delta_{\text{OTAREFSSENS}}$

NOTE 1:  $N_{\text{PRB}}$  is the number of PRBs within the IAB-IMT channel bandwidth defined in section 5.3.2.

**Table H.1.1.1-5: Conditions for RRC connection re-establishment for intra-frequency cell for Local Area IAB-MT and IAB Type 2-O**

IAB-MT channel bandwidth (MHz)	SSB sub-carrier spacing (kHz)	Side conditions	
		SSB $\hat{E}_s/\text{lot}$ (dB)	Minimum SSB_RP (dBm)
50	120	-6	$E_{\text{ISREFSENS}_{50\text{M}}} - 10 \cdot \log_{10}(N_{\text{PRB}} \cdot 12) + \Delta_{\text{FR2\_REFSENS}} - 5$
100, 200, 400	120	-6	$E_{\text{ISREFSENS}_{50\text{M}}} - 10 \cdot \log_{10}(N_{\text{PRB}} \cdot 12) - 2 + \Delta_{\text{FR2\_REFSENS}}$

NOTE 1:  $N_{\text{PRB}}$  is the number of PRBs within the IAB-IMT channel bandwidth defined in section 5.3.2.  
NOTE 2:  $E_{\text{ISREFSENS}_{50\text{M}}}$  for wide area IAB-MT and local area IAB-MT is defined in section 10.3.3.3.

### H.1.1.2 Conditions for Measurements on NR Inter-frequency Cells for RRC Connection Re-establishment

This clause defines the following conditions in terms of SSB\_RP and SSB  $\hat{E}_s/\text{lot}$  for measurements on NR inter-frequency cells for RRC connection re-establishment:

- The conditions are defined in Table H.1.1.2-1 for FR1 NR cells for Wide Area IAB-MT and IAB Type 1-H.
- The conditions are defined in Table H.1.1.2-2 for FR1 NR cells for Local Area IAB-MT and IAB Type 1-H.
- The conditions are defined in Table H.1.1.2-3 for FR1 NR cells for Wide Area IAB-MT and IAB Type 1-O.
- The conditions are defined in Table H.1.1.2-4 for FR1 NR cells for Local Area IAB-MT and IAB Type 1-O.
- The conditions are defined in Table H.1.1.2-5 for FR2-1 NR cells for Local Area and Wide Area IAB-MT and IAB Type 2-O.

**Table H.1.1.2-1: Conditions for RRC connection re-establishment for inter-frequency cell for Wide Area IAB-MT and IAB Type 1-H**

IAB-MT channel bandwidth (MHz)	SSB sub-carrier spacing (kHz)	Side conditions	
		SSB $\hat{E}_s/\text{lot}$ (dB)	Minimum SSB_RP (dBm)
10, 15	30	-4	$-105 - 10 \cdot \log_{10}(N_{\text{PRB}} \cdot 12)$
20, 25, 30, 40, 50, 60, 70, 80, 90, 100	30	-4	$-99.4 - 10 \cdot \log_{10}(N_{\text{PRB}} \cdot 12)$

NOTE 1:  $N_{\text{PRB}}$  is the number of PRBs within the IAB-IMT channel bandwidth defined in section 5.3.2.

**Table H.1.1.2-2: Conditions for RRC connection re-establishment for inter-frequency cell for Local Area IAB-MT and IAB Type 1-H**

IAB-MT channel bandwidth (MHz)	SSB sub-carrier spacing (kHz)	Side conditions	
		SSB $\hat{E}_s/\text{lot}$ (dB)	Minimum SSB_RP (dBm)
10, 15	30	-4	$-97 - 10 \cdot \log_{10}(N_{\text{PRB}} \cdot 12)$
20, 25, 30, 40, 50, 60, 70, 80, 90, 100	30	-4	$-90.5 - 10 \cdot \log_{10}(N_{\text{PRB}} \cdot 12)$

NOTE 1:  $N_{\text{PRB}}$  is the number of PRBs within the IAB-IMT channel bandwidth defined in section 5.3.2.

**Table H.1.1.2-3: Conditions for RRC connection re-establishment for inter-frequency cell for Wide Area IAB-MT and IAB Type 1-O**

IAB-MT channel bandwidth (MHz)	SSB sub-carrier spacing (kHz)	Side conditions	
		SSB $\hat{E}_s/\text{lot}$ (dB)	Minimum SSB_RP (dBm)
10, 15	30	-4	$-105 - 10 \cdot \log_{10}(N_{\text{PRB}} \cdot 12) - \Delta_{\text{OTAREFSSENS}}$
20, 25, 30, 40, 50, 60, 70, 80, 90, 100	30	-4	$-99.4 - 10 \cdot \log_{10}(N_{\text{PRB}} \cdot 12) - \Delta_{\text{OTAREFSSENS}}$

NOTE 1:  $N_{\text{PRB}}$  is the number of PRBs within the IAB-IMT channel bandwidth defined in section 5.3.2.

**Table H.1.1.2-4: Conditions for RRC connection re-establishment for inter-frequency cell for Local Area IAB-MT and IAB Type 1-O**

IAB-MT channel bandwidth (MHz)	SSB sub-carrier spacing (kHz)	Side conditions	
		SSB $\hat{E}_s/\text{lot}$ (dB)	Minimum SSB_RP (dBm)
10, 15	30	-4	$-97 - 10 \cdot \log_{10}(N_{\text{PRB}} \cdot 12) - \Delta_{\text{OTAREFSSENS}}$
20, 25, 30, 40, 50, 60, 70, 80, 90, 100	30	-4	$-90.5 - 10 \cdot \log_{10}(N_{\text{PRB}} \cdot 12) - \Delta_{\text{OTAREFSSENS}}$

NOTE 1:  $N_{\text{PRB}}$  is the number of PRBs within the IAB-IMT channel bandwidth defined in section 5.3.2.

**Table H.1.1.2-5: Conditions for RRC connection re-establishment for inter-frequency cell for Local Area IAB-MT and IAB Type 2-O**

IAB-MT channel bandwidth (MHz)	SSB sub-carrier spacing (kHz)	Side conditions	
		SSB $\hat{E}_s/\text{lot}$ (dB)	Minimum SSB_RP (dBm)
50	120	-4	$E_{\text{ISREFSENS}_{50\text{M}}} - 10 \cdot \log_{10}(N_{\text{PRB}} \cdot 12) + \Delta_{\text{FR2\_REFSENS}} - 3$
100, 200, 400	120	-4	$E_{\text{ISREFSENS}_{50\text{M}}} - 10 \cdot \log_{10}(N_{\text{PRB}} \cdot 12) + \Delta_{\text{FR2\_REFSENS}}$

NOTE 1:  $N_{\text{PRB}}$  is the number of PRBs within the IAB-IMT channel bandwidth defined in section 5.3.2.  
NOTE 2:  $E_{\text{ISREFSENS}_{50\text{M}}}$  for wide area IAB-MT and local area IAB-MT is defined in section 10.3.3.3.

### H.1.1.3 Conditions for Measurements on NR Cells for RRC Connection Release with Redirection

This clause defines the following conditions in terms of SSB\_RP and SSB  $\hat{E}_s/\text{lot}$  for measurements on NR cells for RRC connection release with redirection:

- The conditions are defined in Table H.1.1.3-1 for FR1 NR cells for Wide Area IAB-MT and IAB Type 1-H.
- The conditions are defined in Table H.1.1.3-2 for FR1 NR cells for Local Area IAB-MT and IAB Type 1-H.
- The conditions are defined in Table H.1.1.3-3 for FR1 NR cells for Wide Area IAB-MT and IAB Type 1-O.
- The conditions are defined in Table H.1.1.3-4 for FR1 NR cells for Local Area IAB-MT and IAB Type 1-O.
- The conditions are defined in Table H.1.1.3-5 for FR2-1 NR cells for Local Area and Wide Area IAB-MT and IAB Type 2-O.

**Table H.1.1.3-1: Conditions for RRC connection release with redirection for NR cell for Wide Area IAB-MT and IAB Type 1-H**

IAB-MT channel bandwidth (MHz)	SSB sub-carrier spacing (kHz)	Side conditions	
		SSB $\bar{E}_s/\text{lot}$ (dB)	Minimum SSB_RP (dBm)
10, 15	30	-4	$-105 - 10 \cdot \log_{10}(N_{\text{PRB}} \cdot 12)$
20, 25, 30, 40, 50, 60, 70, 80, 90, 100	30	-4	$-99.4 - 10 \cdot \log_{10}(N_{\text{PRB}} \cdot 12)$

NOTE 1:  $N_{\text{PRB}}$  is the number of PRBs within the IAB-MT channel bandwidth defined in section 5.3.2.

**Table H.1.1.3-2: Conditions for RRC connection release with redirection for NR cell for Local Area IAB-MT and IAB Type 1-H**

IAB-MT channel bandwidth (MHz)	SSB sub-carrier spacing (kHz)	Side conditions	
		SSB $\bar{E}_s/\text{lot}$ (dB)	Minimum SSB_RP (dBm)
10, 15	30	-4	$-97 - 10 \cdot \log_{10}(N_{\text{PRB}} \cdot 12)$
20, 25, 30, 40, 50, 60, 70, 80, 90, 100	30	-4	$-90.5 - 10 \cdot \log_{10}(N_{\text{PRB}} \cdot 12)$

NOTE 1:  $N_{\text{PRB}}$  is the number of PRBs within the IAB-MT channel bandwidth defined in section 5.3.2.

**Table H.1.1.3-3: Conditions for RRC connection release with redirection for NR cell for Wide Area IAB-MT and IAB Type 1-O**

IAB-MT channel bandwidth (MHz)	SSB sub-carrier spacing (kHz)	Side conditions	
		SSB $\bar{E}_s/\text{lot}$ (dB)	Minimum SSB_RP (dBm)
10, 15	30	-4	$-105 - 10 \cdot \log_{10}(N_{\text{PRB}} \cdot 12) - \Delta_{\text{OTAREFSSENS}}$
20, 25, 30, 40, 50, 60, 70, 80, 90, 100	30	-4	$-99.4 - 10 \cdot \log_{10}(N_{\text{PRB}} \cdot 12) - \Delta_{\text{OTAREFSSENS}}$

NOTE 1:  $N_{\text{PRB}}$  is the number of PRBs within the IAB-MT channel bandwidth defined in section 5.3.2.

**Table H.1.1.3-4: Conditions for RRC connection release with redirection for NR cell for Local Area IAB-MT and IAB Type 1-O**

IAB-MT channel bandwidth (MHz)	SSB sub-carrier spacing (kHz)	Side conditions	
		SSB $\bar{E}_s/\text{lot}$ (dB)	Minimum SSB_RP (dBm)
10, 15	30	-4	$-97 - 10 \cdot \log_{10}(N_{\text{PRB}} \cdot 12) - \Delta_{\text{OTAREFSSENS}}$
20, 25, 30, 40, 50, 60, 70, 80, 90, 100	30	-4	$-90.5 - 10 \cdot \log_{10}(N_{\text{PRB}} \cdot 12) - \Delta_{\text{OTAREFSSENS}}$

NOTE 1:  $N_{\text{PRB}}$  is the number of PRBs within the IAB-MT channel bandwidth defined in section 5.3.2.

**Table H.1.1.3-5: Conditions for RRC connection release with redirection for NR cell for Local Area IAB-MT and IAB Type 2-O**

IAB-MT channel bandwidth (MHz)	SSB sub-carrier spacing (kHz)	Side conditions	
		SSB $\bar{E}_s/\text{lot}$ (dB)	Minimum SSB_RP (dBm)
50	120	-4	$E_{\text{ISREFSENS}_{50\text{M}}} - 10 \cdot \log_{10}(N_{\text{PRB}} \cdot 12) + \Delta_{\text{FR2\_REFSENS}} - 3$
100, 200, 400	120	-4	$E_{\text{ISREFSENS}_{50\text{M}}} - 10 \cdot \log_{10}(N_{\text{PRB}} \cdot 12) + \Delta_{\text{FR2\_REFSENS}}$

NOTE 1:  $N_{\text{PRB}}$  is the number of PRBs within the IAB-MT channel bandwidth defined in section 5.3.2.  
NOTE 2:  $E_{\text{ISREFSENS}_{50\text{M}}}$  for wide area IAB-MT and local area IAB-MT is defined in section 10.3.3.3.

# Annex I (normative): Propagation conditions

## I.1 Static propagation condition

The propagation for the static performance measurement is an Additive White Gaussian Noise (AWGN) environment. No fading or multi-paths exist for this propagation model.

### I.1.1 IAB-MT receiver with 2RX

For 1 port transmission the channel matrix is defined in the frequency domain by:

$$\mathbf{H} = \begin{pmatrix} 1 \\ 1 \end{pmatrix}.$$

For 2 port transmission the channel matrix is defined in the frequency domain by:

$$\mathbf{H} = \begin{pmatrix} 1 & j \\ 1 & -j \end{pmatrix}.$$

For 4 port transmission the channel matrix is defined in the frequency domain by:

$$\mathbf{H} = \begin{bmatrix} 1 & 1 & j & j \\ 1 & 1 & -j & -j \end{bmatrix}$$

For 8 port transmission the channel matrix is defined in the frequency domain by:

$$\mathbf{H} = \begin{bmatrix} 1 & 1 & 1 & 1 & j & j & j & j \\ 1 & 1 & 1 & 1 & -j & -j & -j & -j \end{bmatrix}$$

## I.2 Multi-path fading propagation conditions

### I.2.1 General

The multipath propagation conditions consist of several parts:

- A delay profile in the form of a "tapped delay-line", characterized by a number of taps at fixed positions on a sampling grid. The profile can be further characterized by the r.m.s. delay spread and the maximum delay spanned by the taps.
- A combination of channel model parameters that include the Delay profile and the Doppler spectrum that is characterized by a classical spectrum shape and a maximum Doppler frequency.
- Different models are used for FR1 (410 MHz - 7.125 GHz) and FR2-1 (24.25 GHz – 52.6 GHz).

## 1.2.2 Delay profiles

### 1.2.2.1 General

The delay profiles are simplified from the TR 38.901 [27] TDL models. The simplification steps are shown below for information. These steps are only used when new delay profiles are created. Otherwise, the delay profiles specified in 1.2.2.1 can be used as such.

- Step 1: Use the original TDL model from TR 38.901 [27].
- Step 2: Re-order the taps in ascending delays.
- Step 3: Perform delay scaling according to the procedure described in clause 7.7.3 in TR 38.901 [27].
- Step 4: Apply the quantization to the delay resolution 5 ns. This is done simply by rounding the tap delays to the nearest multiple of the delay resolution.
- Step 5: If multiple taps are rounded to the same delay bin, merge them by calculating their linear power sum.
- Step 6: If there are more than 12 taps in the quantized model, merge the taps as follows:
  - Find the weakest tap from all taps (both merged and unmerged taps are considered):
    - If there are two or more taps having the same value and are the weakest, select the tap with the smallest delay as the weakest tap.
  - When the weakest tap is the first delay tap, merge taps as follows:
    - Update the power of the first delay tap as the linear power sum of the weakest tap and the second delay tap.
    - Remove the second delay tap.
  - When the weakest tap is the last delay tap, merge taps as follows:
    - Update the power of the last delay tap as the linear power sum of the second-to-last tap and the last tap.
    - Remove the second-to-last tap.
  - Otherwise:
    - For each side of the weakest tap, identify the neighbour tap that has the smaller delay difference to the weakest tap.
      - When the delay difference between the weakest tap and the identified neighbour tap on one side equals the delay difference between the weakest tap and the identified neighbour tap on the other side.
        - Select the neighbour tap that is weaker in power for merging.
      - Otherwise, select the neighbour tap that has smaller delay difference for merging.
  - To merge, the power of the merged tap is the linear sum of the power of the weakest tap and the selected tap.
  - When the selected tap is the first tap, the location of the merged tap is the location of the first tap. The weakest tap is removed.
  - When the selected tap is the last tap, the location of the merged tap is the location of the last tap. The weakest tap is removed.
  - Otherwise, the location of the merged tap is based on the average delay of the weakest tap and selected tap. If the average delay is on the sampling grid, the location of the merged tap is the average delay. Otherwise, the location of the merged tap is rounded towards the direction of the selected tap (e.g. 10 ns & 20 ns → 15 ns, 10 ns & 25 ns → 20 ns, if 25 ns had higher or equal power; 15 ns, if 10 ns had higher power). The weakest tap and the selected tap are removed.

- Repeat step 6 until the final number of taps is 12.
- Step 7: Round the amplitudes of taps to one decimal (e.g. -8.78 dB → -8.8 dB)
- Step 8: If the delay spread has slightly changed due to the tap merge, adjust the final delay spread by increasing or decreasing the power of the last tap so that the delay spread is corrected.
- Step 9: Re-normalize the highest tap to 0 dB.

NOTE 1: Some values of the delay profile created by the simplification steps may differ from the values in tables I.2.2.2-2, I.2.2.2-3, and I.2.1.1-4 for the corresponding model.

NOTE 2: For Step 5 and Step 6, the power values are expressed in the linear domain using 6 digits of precision. The operations are in the linear domain.

## I.2.2.2 Delay profiles for FR1

The delay profiles for FR1 are selected to be representative of low, medium and high delay spread environment. The resulting model parameters are specified in I.2.2.2-1 and the tapped delay line models are specified in tables I.2.2.2-2 ~ table I.2.2.2-4.

**Table I.2.2.2-1: Delay profiles for NR channel models**

Model	Number of channel taps	Delay spread (r.m.s.)	Maximum excess tap delay (span)	Delay resolution
TDLA30	12	30 ns	290 ns	5 ns
TDLB100	12	100 ns	480 ns	5 ns
TDLC300	12	300 ns	2595 ns	5 ns

**Table I.2.2.2-2: TDLA30 (DS = 30 ns)**

Tap #	Delay (ns)	Power (dB)	Fading distribution
1	0	-15.5	Rayleigh
2	10	0	
3	15	-5.1	
4	20	-5.1	
5	25	-9.6	
6	50	-8.2	
7	65	-13.1	
8	75	-11.5	
9	105	-11.0	
10	135	-16.2	
11	150	-16.6	
12	290	-26.2	

**Table I.2.2.2-3: TDLB100 (DS = 100ns)**

Tap #	Delay (ns)	Power (dB)	Fading distribution
1	0	0	Rayleigh
2	10	-2.2	
3	20	-0.6	
4	30	-0.6	
5	35	-0.3	
6	45	-1.2	
7	55	-5.9	
8	120	-2.2	
9	170	-0.8	
10	245	-6.3	
11	330	-7.5	
12	480	-7.1	



Table I.2.2.2-4: TDLC300 (DS = 300 ns)

Tap #	Delay (ns)	Power (dB)	Fading distribution
1	0	-6.9	Rayleigh
2	65	0	
3	70	-7.7	
4	190	-2.5	
5	195	-2.4	
6	200	-9.9	
7	240	-8.0	
8	325	-6.6	
9	520	-7.1	
10	1045	-13.0	
11	1510	-14.2	
12	2595	-16.0	

### I.2.3 Combinations of channel model parameters

The propagation conditions used for the performance measurements in multi-path fading environment are indicated as a combination of a channel model name and a maximum Doppler frequency, i.e., TDLA<DS>-<Doppler>, TDLB<DS>-<Doppler> or TDLC<DS>-<Doppler> where '<DS>' indicates the desired delay spread and '<Doppler>' indicates the maximum Doppler frequency (Hz).

Table I.2.3-1 show the propagation conditions that are used for the performance measurements in multi-path fading environment for low, medium and high Doppler frequencies for FR1.

Table I.2.3-1: Channel model parameters for FR1

Combination name	Model	Maximum Doppler frequency
TDLA30-5	TDLA30	5 Hz
TDLA30-10	TDLA30	10 Hz
TDLB100-400	TDLB100	400 Hz
TDLC300-100	TDLC300	100 Hz

### I.2.4 MIMO channel correlation matrices

#### I.2.4.1 General

The MIMO channel correlation matrices defined in annex I.2.4 apply for the antenna configuration using uniform linear arrays at both IAB-DU/gNB and IAB-MT/UE and for the antenna configuration using cross polarized antennas.

#### I.2.4.2 MIMO correlation matrices using Uniform Linear Array

##### I.2.4.2.1 General

The MIMO channel correlation matrices defined in annex I.2.4.2 apply for the antenna configuration using uniform linear array (ULA) at both IAB-DU/gNB and IAB-MT/UE.

##### I.2.4.2.2 Definition of MIMO correlation matrices

Table I.2.4.2.2-1 defines the correlation matrix for the IAB-DU or gNB.

**Table I.2.4.2.2-1: IAB-DU or gNB correlation matrix**

IAB-DU or gNB correlation	
One antenna	$R_{gNB} = 1$
Two antennas	$R_{gNB} = \begin{pmatrix} 1 & \alpha \\ \alpha^* & 1 \end{pmatrix}$
Four antennas	$R_{gNB} = \begin{pmatrix} 1 & \alpha^{1/9} & \alpha^{4/9} & \alpha \\ \alpha^{1/9*} & 1 & \alpha^{1/9} & \alpha^{4/9} \\ \alpha^{4/9*} & \alpha^{1/9*} & 1 & \alpha^{1/9} \\ \alpha^* & \alpha^{4/9*} & \alpha^{1/9*} & 1 \end{pmatrix}$
Eight antennas	$R_{gNB} = \begin{pmatrix} 1 & \alpha^{1/49} & \alpha^{4/49} & \alpha^{9/49} & \alpha^{16/49} & \alpha^{25/49} & \alpha^{36/49} & \alpha \\ \alpha^{1/49*} & 1 & \alpha^{1/49} & \alpha^{4/49} & \alpha^{9/49} & \alpha^{16/49} & \alpha^{25/49} & \alpha^{36/49} \\ \alpha^{4/49*} & \alpha^{1/49*} & 1 & \alpha^{1/49} & \alpha^{4/49} & \alpha^{9/49} & \alpha^{16/49} & \alpha^{25/49} \\ \alpha^{9/49*} & \alpha^{4/49*} & \alpha^{1/49*} & 1 & \alpha^{1/49} & \alpha^{4/49} & \alpha^{9/49} & \alpha^{16/49} \\ \alpha^{16/49*} & \alpha^{9/49*} & \alpha^{4/49*} & \alpha^{1/49*} & 1 & \alpha^{1/49} & \alpha^{4/49} & \alpha^{9/49} \\ \alpha^{25/49*} & \alpha^{16/49*} & \alpha^{9/49*} & \alpha^{4/49*} & \alpha^{1/49*} & 1 & \alpha^{1/49} & \alpha^{4/49} \\ \alpha^{36/49*} & \alpha^{25/49*} & \alpha^{16/49*} & \alpha^{9/49*} & \alpha^{4/49*} & \alpha^{1/49*} & 1 & \alpha^{1/49} \\ \alpha^* & \alpha^{36/49*} & \alpha^{25/49*} & \alpha^{16/49*} & \alpha^{9/49*} & \alpha^{4/49*} & \alpha^{1/49*} & 1 \end{pmatrix}$
NOTE: The matrix applies to the IAB-DU for IAB-DU requirements and gNB for IAB-MT requirements.	

Table I.2.4.2.2-2 defines the correlation matrix for the IAB-MT or UE:

**Table I.2.4.2.2-2: IAB-MT or UE correlation matrix**

	One antenna	Two antennas	Four antennas
IAB-MT / UE correlation	$R_{UE} = 1$	$R_{UE} = \begin{pmatrix} 1 & \beta \\ \beta^* & 1 \end{pmatrix}$	$R_{UE} = \begin{pmatrix} 1 & \beta^{1/9} & \beta^{4/9} & \beta \\ \beta^{1/9*} & 1 & \beta^{1/9} & \beta^{4/9} \\ \beta^{4/9*} & \beta^{1/9*} & 1 & \beta^{1/9} \\ \beta^* & \beta^{4/9*} & \beta^{1/9*} & 1 \end{pmatrix}$
NOTE: The matrix applies to the UE for IAB-DU requirements and IAB-MT for IAB-MT requirements.			

Table I.2.4.2.2-3 defines the channel spatial correlation matrix  $R_{spat}$ . The parameters,  $\alpha$  and  $\beta$  in table I.2.4.2.2-3 defines the spatial correlation between the antennas at the IAB-DU/gNB and IAB-MT/UE respectively.

**Table I.2.4.2.3-3:  $R_{spat}$  correlation matrices**

1x2 case	$R_{spat} = R_{gNB} = \begin{bmatrix} 1 & \alpha \\ \alpha^* & 1 \end{bmatrix}$
1x4 case	$R_{spat} = R_{gNB} = \begin{pmatrix} 1 & \alpha^{1/9} & \alpha^{4/9} & \alpha \\ \alpha^{1/9*} & 1 & \alpha^{1/9} & \alpha^{4/9} \\ \alpha^{4/9*} & \alpha^{1/9*} & 1 & \alpha^{1/9} \\ \alpha^* & \alpha^{4/9*} & \alpha^{1/9*} & 1 \end{pmatrix}$
2x2 case	$R_{spat} = R_{UE} \otimes R_{gNB} = \begin{pmatrix} 1 & \beta \\ \beta^* & 1 \end{pmatrix} \otimes \begin{pmatrix} 1 & \alpha \\ \alpha^* & 1 \end{pmatrix} = \begin{pmatrix} 1 & \alpha & \beta & \beta\alpha \\ \alpha^* & 1 & \beta\alpha^* & \beta \\ \beta^* & \beta^*\alpha & 1 & \alpha \\ \beta^*\alpha^* & \beta^* & \alpha^* & 1 \end{pmatrix}$
2x4 case	$R_{spat} = R_{UE} \otimes R_{gNB} = \begin{pmatrix} 1 & \beta \\ \beta^* & 1 \end{pmatrix} \otimes \begin{pmatrix} 1 & \alpha^{1/9} & \alpha^{4/9} & \alpha \\ \alpha^{1/9*} & 1 & \alpha^{1/9} & \alpha^{4/9} \\ \alpha^{4/9*} & \alpha^{1/9*} & 1 & \alpha^{1/9} \\ \alpha^* & \alpha^{4/9*} & \alpha^{1/9*} & 1 \end{pmatrix}$
4x4 case	$R_{spat} = R_{UE} \otimes R_{gNB} = \begin{pmatrix} 1 & \beta^{1/9} & \beta^{4/9} & \beta \\ \beta^{1/9*} & 1 & \beta^{1/9} & \beta^{4/9} \\ \beta^{4/9*} & \beta^{1/9*} & 1 & \beta^{1/9} \\ \beta^* & \beta^{4/9*} & \beta^{1/9*} & 1 \end{pmatrix} \otimes \begin{pmatrix} 1 & \alpha^{1/9} & \alpha^{4/9} & \alpha \\ \alpha^{1/9*} & 1 & \alpha^{1/9} & \alpha^{4/9} \\ \alpha^{4/9*} & \alpha^{1/9*} & 1 & \alpha^{1/9} \\ \alpha^* & \alpha^{4/9*} & \alpha^{1/9*} & 1 \end{pmatrix}$
NOTE 1: $R_{gNB}$ refers to an IAB-DU for IAB-DU requirements or a gNB for IAB-MT requirements. NOTE 2: $R_{UE}$ refers to an UE for IAB-DU requirements or and IAB-MT for IAB-MT requirements	

For cases with more antennas at either IAB-DU/gNB or IAB-MT/UE or both, the channel spatial correlation matrix can still be expressed as the Kronecker product of  $R_{UE}$  and  $R_{gNB}$  according to  $R_{spat} = R_{UE} \otimes R_{gNB}$ .

**1.2.4.2.3 MIMO correlation matrices at high, medium and low level**

The  $\alpha$  and  $\beta$  for different correlation types are given in table I.2.4.2.3-1.

**Table I.2.4.2.3-1: Correlation for high, medium and low level**

Low correlation		Medium correlation		High correlation	
$\alpha$	$\beta$	$\alpha$	$\beta$	$\alpha$	$\beta$
0	0	0.9	0.3	0.9	0.9

The correlation matrices for high, medium and low correlation are defined in table I.2.4.2.3-2, I.2.4.2.3-3 and I.2.4.2.3-4 as below.

The values in table I.2.4.2.3-2 have been adjusted for the 2x4 and 4x4 high correlation cases to ensure the correlation matrix is positive semi-definite after round-off to 4 digit precision. This is done using the equation:

$$\mathbf{R}_{high} = [\mathbf{R}_{spatial} + a\mathbf{I}_n] / (1 + a)$$

Where the value "a" is a scaling factor such that the smallest value is used to obtain a positive semi-definite result. For the 2x4 high correlation case, a = 0.00010. For the 4x4 high correlation case, a = 0.00012.

The same method is used to adjust the 4x4 medium correlation matrix in table I.2.4.2.3-3 to insure the correlation matrix is positive semi-definite after round-off to 4 digit precision with a = 0.00012.



**Table I.2.4.2.3-4: MIMO correlation matrices for low correlation**

1x2 case	$R_{low} = \mathbf{I}_2$
1x4 case	$R_{low} = \mathbf{I}_4$
1x8 case	$R_{low} = \mathbf{I}_8$
2x2 case	$R_{low} = \mathbf{I}_4$
2x4 case	$R_{low} = \mathbf{I}_8$
2x4 case	$R_{low} = \mathbf{I}_{16}$
4x4 case	$R_{low} = \mathbf{I}_{16}$

In table I.2.4.2.3-4,  $\mathbf{I}_d$  is a  $d \times d$  identity matrix.

NOTE: For completeness, the correlation matrices were defined for high, medium and low correlation but performance requirements exist only for low correlation.

### I.2.4.3 Multi-antenna channel models using cross polarized antennas

#### I.2.4.3.1 General

The MIMO channel correlation matrices defined in annex I.2.4.3 apply to two cases as presented below:

- One TX antenna and multiple RX antennas case, with cross polarized antennas used at IAB-DU/gNB
- Multiple TX antennas and multiple RX antennas case, with cross polarized antennas used at IAB-MT/UE

The cross-polarized antenna elements with +/-45 degrees polarization slant angles are deployed at IAB. For one TX antenna case, antenna element with +90 degree polarization slant angle is deployed at IAB-MT/UE. For multiple TX antennas case, cross-polarized antenna elements with +90/0 degrees polarization slant angles are deployed at IAB-MT/UE.

For the cross-polarized antennas, the N antennas are labelled such that antennas for one polarization are listed from 1 to N/2 and antennas for the other polarization are listed from N/2+1 to N, where N is the number of TX or RX antennas.

#### I.2.4.3.2 Definition of MIMO correlation matrices using cross polarized antennas

For the channel spatial correlation matrix, the following is used:

$$R_{spat} = P_{UL} (R_{UE} \otimes \Gamma_{UL} \otimes R_{gNB}) P_{UL}^T$$

Where

- $R_{UE}$  is the spatial correlation matrix at the UE (IAB-DU requirements) or IAB-MT (IAB-MT requirements) with same polarization,
- $R_{gNB}$  is the spatial correlation matrix at the IAB-DU (IAB-DU requirements) or gNB (IAB-MT requirements) with same polarization,
- $\Gamma_{UL}$  is a polarization correlation matrix,
- $P_{UL}$  is a permutation matrix, and
- $(\bullet)^T$  denotes transpose.

Table I.2.4.3.2-1 defines the polarization correlation matrix.

Table I.2.4.3.2-1: Polarization correlation matrix

	One TX antenna	Multiple TX antennas
Polarization correlation matrix	$\Gamma_{UL} = \begin{bmatrix} 1 & -\gamma \\ -\gamma & 1 \end{bmatrix}$	$\Gamma_{UL} = \begin{bmatrix} 1 & -\gamma & 0 & 0 \\ -\gamma & 1 & 0 & 0 \\ 0 & 0 & 1 & \gamma \\ 0 & 0 & \gamma & 1 \end{bmatrix}$

The matrix  $P_{UL}$  is defined as

$$\mathbf{P}_{UL}(a,b) = \begin{cases} 1 & \text{for } a = (j-1)Nr + i \text{ and } b = 2(j-1)Nr + i, & i = 1, \dots, Nr, j = 1, \dots, \lceil Nt/2 \rceil \\ 1 & \text{for } a = (j-1)Nr + i \text{ and } b = 2(j - Nt/2)Nr - Nr + i, & i = 1, \dots, Nr, j = \lceil Nt/2 \rceil + 1, \dots, Nt \\ 0 & \text{otherwise} \end{cases}$$

where  $Nt$  and  $Nr$  is the number of TX and RX antennas respectively, and  $\lceil \bullet \rceil$  is the ceiling operator.

The matrix  $P_{UL}$  is used to map the spatial correlation coefficients in accordance with the antenna element labelling system described in I.2.4.3.

### I.2.4.3.3 Spatial correlation matrices at IAB-MT/UE and IAB-DU/gNB sides

#### I.2.4.3.3.1 Spatial correlation matrices at IAB-MT/UE side

In this subclause,  $R_{UE}$  refers to a UE for IAB-DU requirements or an IAB-MT for IAB-MT requirements.

For 1-antenna transmitter,  $R_{UE} = 1$ .

For 2-antenna transmitter using one pair of cross-polarized antenna elements,  $R_{UE} = 1$ .

For 4-antenna transmitter using two pairs of cross-polarized antenna elements,  $R_{UE} = \begin{pmatrix} 1 & \beta \\ \beta^* & 1 \end{pmatrix}$ .

#### I.2.4.3.3.2 Spatial correlation matrices at IAB-DU/gNB side

In this subclause,  $R_{gNB}$  refers to an IAB-DU for IAB-DU requirements or a gNB for IAB-MT requirements.

For 2-antenna receiver using one pair of cross-polarized antenna elements,  $R_{gNB} = 1$ .

For 4-antenna receiver using two pairs of cross-polarized antenna elements,  $R_{gNB} = \begin{bmatrix} 1 & \alpha \\ \alpha^* & 1 \end{bmatrix}$ .

For 8-antenna receiver using four pairs of cross-polarized antenna elements,  $R_{gNB} = \begin{pmatrix} 1 & \alpha^{1/9} & \alpha^{4/9} & \alpha \\ \alpha^{1/9*} & 1 & \alpha^{1/9} & \alpha^{4/9} \\ \alpha^{4/9*} & \alpha^{1/9*} & 1 & \alpha^{1/9} \\ \alpha^* & \alpha^{4/9*} & \alpha^{1/9*} & 1 \end{pmatrix}$ .

### I.2.4.3.4 MIMO correlation matrices using cross polarized antennas

The values for parameters  $\alpha$ ,  $\beta$  and  $\gamma$  for low spatial correlation are given in table I.2.4.3.4-1.

**Table I.2.4.3.4-1: Values for parameters  $\alpha$ ,  $\beta$  and  $\gamma$** 

Low spatial correlation		
$\alpha$	$\beta$	$\gamma$
0	0	0
NOTE 1: Value of $\alpha$ applies when more than one pair of cross-polarized antenna elements at IAB-DU/gNB side.		
NOTE 2: Value of $\beta$ applies when more than one pair of cross-polarized antenna elements at IAB-MT/UE side.		

The correlation matrices for low spatial correlation are defined in table I.2.4.3.4-2 as below.

**Table I.2.4.3.4-2: MIMO correlation matrices for low spatial correlation**

1x8 case	$R_{low} = \mathbf{I}_8$
2x8 case	$R_{low} = \mathbf{I}_{16}$

In table I.2.4.3.4-2,  $\mathbf{I}_d$  is a  $d \times d$  identity matrix.

### I.2.4.3.5 Beam steering approach

For the 2D cross-polarized antenna array at gNB, given the channel spatial correlation matrix in I.2.4.3.2, I.2.4.3.3 and I.2.4.3.4, the corresponding random channel matrix  $H$  can be calculated. The signal model for the  $k$ -th slot is denoted as

$$y = HD_{\theta_{k,1}, \theta_{k,2}} Wx + n$$

And the steering matrix is further expressed as following:

$$D_{\theta_{k,1}, \theta_{k,2}} = \begin{bmatrix} 1 & 0 \\ 0 & 1 \end{bmatrix} \otimes (D_{\theta_{k,1}}(N_1) \otimes D_{\theta_{k,2}}(N_2))$$

where

- $H$  is the  $N_r \times N_t$  channel matrix per subcarrier.
- $D_{\theta_{k,1}, \theta_{k,2}}$  is the steering matrix,
- $D_{\theta_{k,1}}(N_1)$  is the steering matrix in first dimension with same polarization,
- $D_{\theta_{k,2}}(N_2)$  is the steering matrix in second dimension with same polarization,
- $N_1$  is the number of antenna elements in first dimension with same polarization,
- $N_2$  is the number of antenna elements in second dimension with same polarization,
- For antenna array with only one direction, number of antenna element in second direction  $N_2$  equals 1.

For 1 antenna element with the same polarization in one direction,

$$D_{\theta_{k,i}}(1) = 1$$

For 2 antenna elements with the same polarization in one direction,

$$D_{\theta_{k,i}}(2) = \begin{bmatrix} 1 & 0 \\ 0 & e^{j3\theta_{k,i}} \end{bmatrix}$$

For 3 antenna elements with the same polarization in one direction,

$$D_{\theta_{k,i}}(3) = \begin{bmatrix} 1 & 0 & 0 \\ 0 & e^{j1.5\theta_{k,i}} & 0 \\ 0 & 0 & e^{j3\theta_{k,i}} \end{bmatrix}$$

For 4 antenna elements with the same polarization in one direction,

$$D_{\theta_{k,i}}(4) = \begin{bmatrix} 1 & 0 & 0 & 0 \\ 0 & e^{j\theta_{k,i}} & 0 & 0 \\ 0 & 0 & e^{j2\theta_{k,i}} & 0 \\ 0 & 0 & 0 & e^{j3\theta_{k,i}} \end{bmatrix}$$

where the index  $i=1,2$  stands for first dimension and second dimension respectively.

- $\theta_{k,i}$  controls the phase variation in first dimension and second dimension respectively, and the phase for k-th subframe is denoted by  $\theta_{k,i} = \theta_{0,i} + \Delta\theta k$ , where  $\theta_{0,i}$  is the random start value with the uniform distribution, i.e.,  $\theta_{0,i} \in [0, 2\pi]$ ,  $\Delta\theta$  is the step of phase variation, which is defined in Table I.2.4.3.5-1, and k is the linear increment of  $2^{-\mu}$  for every slot throughout the simulation, the index  $i=1,2$  stands for first dimension and second dimension respectively.
- $W$  is the precoding matrix for  $N_t$  transmission antennas,
- $y$  is the received signal,  $x$  is the transmitted signal, and  $n$  is AWGN.
- $\mu$  corresponds to subcarrier spacing configuration,  $\Delta f = 2^\mu \cdot 15$ [kHz]

For the 1D cross-polarized antenna array at gNB, the corresponding random channel matrix  $H$  can be calculated by letting  $N_2=1$ , i.e.,

$$D_{\theta_{k,1}} = \begin{bmatrix} 1 & 0 \\ 0 & 1 \end{bmatrix} \otimes D_{\theta_{k,1}}(N_1)$$

**Table I.2.4.3.5-1: The step of phase variation**

Variation Step	Value (rad/ms)
$\Delta\theta$	$1.2566 \times 10^{-3}$

## I.3 Physical signals, channels mapping and precoding

### I.3.1 General

Unless otherwise stated, the transmission on antenna port(s)  $p = p_0, p_0 + 1, \dots, p_0 + N_p - 1$  is defined by using a precoder matrix  $W(i)$  of size  $N_{ANT} \times N_p$ , where  $N_{ANT}$  is the number of physical transmit antenna elements configured per test,  $N_p$  is the number of ports for a reference signal or physical channel configured per test, and  $p_0$  is the first port for that reference signal or physical channel as defined in clauses 7.3 and 7.4 in TS 38.211 [8]. This precoder takes as an input a block of signals for antenna port(s)  $p = p_0, p_0 + 1, \dots, p_0 + N_p - 1$ ,  $y^{(p)}(i) =$



$[y^{(p_0)}(i) \ y^{(p_0+1)}(i) \ \dots \ y^{(p_0+N_p-1)}(i)]^T$ ,  $i = 0, 1, \dots, M_{\text{symb}}^{\text{ap}} - 1$ , with  $M_{\text{symb}}^{\text{ap}}$  being the number of modulation symbols per antenna port including the reference signal symbols, and generates a block of signals  $y_{bf}^{(q)}(i) = [y_{bf}^{(0)}(i) \ y_{bf}^{(1)}(i) \ \dots \ y_{bf}^{(N_{\text{ANT}}-1)}(i)]^T$  the elements of which are to be mapped onto the frequency-time index pair  $(k, l)$  as per the test configuration but transmitted on different physical antenna elements:

$$y_{bf}^{(q)}(i) = W(i)y^{(p)}(i)$$

For Clause 8.2.3 and 11.2.3, the transmission of PDCCH and PDCCH DMRS on antenna port  $p = p_0$  is defined by using a precoder matrix  $W(i)$  of size  $2 \times 1$ . This precoder takes as an input a block of signals for antenna port(s)  $p = p_0$ ,

$y^{(p)}(i) = y^{(p_0)}(i)$  and generates a block of signals  $y_{bf}^{(q)}(i) = [y_{bf}^{(0)}(i) \ y_{bf}^{(\frac{N_{\text{ANT}}}{2})}(i)]^T$  the elements of which are to be

mapped onto the frequency-time index pair  $(k, l)$  as per the test configuration but transmitted on different physical antenna elements:

$$y_{bf}^{(q)}(i) = W(i)y^{(p)}(i)$$

The precoder matrix  $W(i)$  is specific to the test case configuration.  $W(i)$  is defined in Clause 5.2.2.2 of TS 38.214 [11].

The transmission on PT-RS antenna port is associated (using same precoder) with the lowest indexed DM-RS antenna port among the DM-RS antenna ports assigned for the PDSCH.

The physical antenna elements are identified by indices  $j = 0, 1, \dots, N_{\text{ANT}} - 1$ , where  $N_{\text{ANT}}$  is the number of physical antenna elements configured per test.

Modulation symbols  $y^{(p)}(i)$  with  $p \in \{4000\}$  (i.e. PSS, SSS, PBCH and DM-RS for PBCH) are directly mapped to first physical antenna element.

Modulation symbols  $a_{k,l}$  for CSI-RS resources which configured for tracking with one port are directly mapped to first physical antenna element.

Modulation symbols  $a_{k,l}$  for CSI-RS resources which configured for beam refinement with one port are directly mapped to first physical antenna element.

Modulation symbols  $a_{k,l}^{(p)}$  for NZP CSI-RS which configured for CSI acquisition with

$p \in \{p_0, p_0 + 1, \dots, p_0 + N_{\text{CSI}} - 1\}$  are mapped to the physical antenna index  $j = p - p_0$  where  $N_{\text{CSI}}$  is the number of NZP CSI-RS ports configured per test.

## Annex J (informative): Change history

Change history							
Date	Meeting	TDoc	CR	Rev	Cat	Subject/Comment	New version
09/2019	RAN4#92	R4-1910404				Initial TS skeleton	0.0.1
06/2020	RAN4#95-e	R4-2007467				Update of IAB TS with agreed TP in RAN4#95-e: R4-2007991 TP to TS 38.174 v0.0.1: Adding references related to IAB R4-2008769 TP to TS 38.174: system parameter R4-2006275 TP for TS 38.174: IAB-DU Transmitted signal quality R4-2008778 TP for TS 38.174: Transmit ON/OFF power R4-2008788 TP to TS 38.174: IAB RX IM requirement (section 7.7 and 10.8) R4-2008791 TP to TS 38.174: IAB ICS requirement (section 7.8 and 10.9) R4-2008795 TP to TS 38.174: OTA ACS R4-2008796 TP to TS 38.174: OTA RX spurious R4-2008798 TP to TS 38.174: OTA Inband blocking R4-2008799 TP to TS 38.174: Conducted RX spurious R4-2008800 TP to TS 38.174 -IAB-DU RX sensitivity R4-2008801 TP to TS 38.174 -IAB-DU Rx dynamic range R4-2009063 TP to TS 38.174 -IAB-DU TX dynamic range R4-2008596 TP to TS 38.174 RRM IAB TS R4-2008597 TP to TS 38.174 v0.0.1: Updates to RRC re-establishment requirements for IAB MT R4-2008598 TP to TS 38.174 v0.0.1: Updates to RRC re-direction requirements for IAB MT R4-2008599 TP to TS 38.174 Transmit Timing requirements for IAB-MT R4-2008600 TP for IAB RLM R4-2008601 TP to TS 38.174 v0.0.1: Beam Candidate Detection Requirements for IAB MT R4-2008611 TP to TS 38.174 on BFD requirements of IAB-MTs	0.1.0
09/2020	Ran4#96-e	R4-2012566				Update of IAB TS with agreed TPs in RAN4#96-e R4-2012108: Removing editor's notes and replacing TBD with appropriate numbers R4-2012234: RLM requirements for IAB MTs R4-2012614: IAB-MT classes, applicability of requirements, requirements for contiguous and non-contiguous spectrum R4-2012618: Output power dynamics, Radiated transmit power, OTA output power R4-2012620: IAB Output power, Radiated transmit power R4-2012621: Output power dynamics, OTA output power dynamics R4-2012622: Appendices, frequency error, modulation quality, OTA frequency error, OTA modulation quality R4-2012624: Unwanted emissions, OTA unwanted emissions R4-2012626: Transmitter intermodulation, OTA transmitter intermodulation R4-2012628: Reference sensitivity level, dynamic range, OTA sensitivity, OTA dynamic range, fixed reference channels for reference sensitivity R4-2012631: In-band selectivity and blocking, out-of-band blocking, OTA out-of-band blocking R4-2012633: Receiver intermodulation, OTA receiver intermodulation R4-2012760: IAB-MT receiver spurious emissions, OTA IAB-MT receiver spurious emissions	0.2.0
2020-09	RAN#89	RP-01909				Draft version for information purposes to the RAN Plenary	1.0.0
2020-09	RAN#89	RP-01979				Minor editorial corrections	1.0.1
2020-09	RAN#89	RP-01979				Approved by plenary – Rel-16 spec under change control	16.0.0
2020-12	RAN#90	RP-202504	0006		F	Correction CR on TS38.174	16.1.0
2021-03	RAN#91	RP-210170	0011		F	Big CR to TR 38.174 – correction to clause 6	16.2.0
2021-06	RAN#92	RP-211101	0015		F	CR on maintenance on sharing factor of RLM and link recovery for IAB-MT	16.3.0
2021-06	RAN#92	RP-211101	0016	1	B	Big CR on IAB-MT demodulation in TS 38.174	16.3.0
2021-06	RAN#92	RP-211101	0018	1	B	Big CR: IAB-MT RRM test cases in 38.174	16.3.0
2021-06	RAN#92	RP-211101	0020		F	Big CR for update Core part of TS 38.174	16.3.0

2021-09	RAN#93	RP-211892	0021		F	Big CR for TS 38.174 Maintenance (Rel-16, CAT F)	16.4.0
2021-12	RAN#94	RP-212851	0022		F	Big CR for TS 38.174 Maintenance (Rel-16, CAT F)	16.5.0
2022-03	RAN#95	RP-220374	0024		B	Big CR to TS38.174 for Rel-17 IAB enhancement	17.0.0
2022-03	RAN#95	RP-220334	0026		F	Big CR for TS 38.174 Maintenance (Rel-16, CAT F)	16.6.0

Change history							
Date	Meeting	TDoc	CR	Rev	Cat	Subject/Comment	New version
2022-03	RAN#95					Approved by plenary – Rel-17 spec under change control	17.0.0
2022-06	RAN#96	RP-221673	0027		B	Introducing 6GHz licensed operation into 38.174	17.1.0
2022-06	RAN#96	RP-221665	0033	1	F	Big CR for TS 38.174 Maintenance (Rel-17, CAT F)	17.1.0
2022-06	RAN#96	RP-221665	0035		A	Big CR on TS 38.174 Maintenance (Rel-17)	17.1.0
2022-12	RAN#98-e	RP-223310	0038	1	F	CR on case-6 timing for eIAB_RF	17.2.0
2023-03	RAN#99	RP-230515	0042		F	Correction to IAB-MT timing reference point in TS 38.174	17.3.0
2023-06	RAN#100	RP-231353	0044		A	CR for TS 38.174, Correction on OTA IAB output power etc.	17.4.0
2023-06	RAN#100	RP-231353	0047		A	CR on maintenance for IAB R17	17.4.0
2023-06	RAN#100	RP-231353	0050		A	Clean up for IAB demodulation requirements in TS 38.174 (Rel-17)	17.4.0
2023-06	RAN#100	RP-231356	0052	1	F	CR to TS 38.174 Maintenance of IAB for supported BW R17	17.4.0
2023-09	RAN#101	RP-232491	0055		F	[NR_IAB_enh-Core] CR to TS 38.174: Addition of missing bands for IAB co-existence and co-location requirements	17.5.0
2023-09	RAN#101	RP-232491	0058		A	CR for TS 38.174, Correction on scaling factor for IAB-MT type 1-O	17.5.0
2023-09	RAN#101	RP-232491	0061		A	[NR_IAB-Core] CR on maintenance of RRM requirements for IAB R17	17.5.0
2023-09	RAN#101	RP-232491	0066	1	F	CR to correct FR2 range in IAB specification	17.5.0
2023-09	RAN#101	RP-232491	0068		F	Correction to applicable FR2 range for IAB-MT RRM core requirements	17.5.0
2023-09	RAN#101	RP-232491	0071		A	[NR_IAB-Perf] CR on NR IAB performance requirements (TS38.174, Rel-17)	17.5.0
2023-12	RAN#102	RP-233347	0080		F	CR to TS 38.174 with correction of co-location requirements	17.6.0
2023-12	RAN#102	RP-233347	0086		F	CR to update FR2 range in IAB specification	17.6.0
2023-12	RAN#102	RP-233347	0091		F	[NR_IAB_enh] Correction to IAB-MT TA adjustment accuracy requirements	17.6.0
2023-12	RAN#102	RP-233347	0093		F	[NR_IAB_enh] Correction to applicable FR2 range in IAB-MT RRM performance requirements	17.6.0
2024-03	RAN#103	RP-240560	0097		A	(NR_IAB-Core) CR for TS 38.174, Correction on BS related description issues	17.7.0
2024-03	RAN#103	RP-240560	0100		A	(NR_IAB-Core)CR for TS 38.174, Correction on scaling factor for IAB-MT type 1-O	17.7.0
2024-03	RAN#103	RP-240560	0103		A	(NR_IAB-Perf) Reference Table Correction in 38.174	17.7.0

---

# History

<b>Document history</b>		
V17.0.0	April 2022	Publication
V17.1.0	August 2022	Publication
V17.2.0	January 2023	Publication
V17.3.0	July 2023	Publication
V17.4.0	July 2023	Publication
V17.5.0	October 2023	Publication
V17.6.0	February 2024	Publication
V17.7.0	May 2024	Publication