

ETSI TS 138 561 V18.1.0 (2025-01)



**5G;
NR;
User Equipment (UE) conformance specification;
UE TRP (Total Radiated Power) and TRS
(Total Radiated Sensitivity) requirements and test
methodologies for FR1 (NR SA and EN-DC)
(3GPP TS 38.561 version 18.1.0 Release 18)**



Reference

RTS/TSGR-0538561vi10

Keywords

5G

ETSI

650 Route des Lucioles
F-06921 Sophia Antipolis Cedex - FRANCE

Tel.: +33 4 92 94 42 00 Fax: +33 4 93 65 47 16

Siret N° 348 623 562 00017 - APE 7112B
Association à but non lucratif enregistrée à la
Sous-Préfecture de Grasse (06) N° w061004871

Important notice

The present document can be downloaded from the
[ETSI Search & Browse Standards application](#).

The present document may be made available in electronic versions and/or in print. The content of any electronic and/or print versions of the present document shall not be modified without the prior written authorization of ETSI. In case of any existing or perceived difference in contents between such versions and/or in print, the prevailing version of an ETSI deliverable is the one made publicly available in PDF format on [ETSI deliver repository](#).

Users should be aware that the present document may be revised or have its status changed, this information is available in the [Milestones listing](#).

If you find errors in the present document, please send your comments to the relevant service listed under [Committee Support Staff](#).

If you find a security vulnerability in the present document, please report it through our [Coordinated Vulnerability Disclosure \(CVD\)](#) program.

Notice of disclaimer & limitation of liability

The information provided in the present deliverable is directed solely to professionals who have the appropriate degree of experience to understand and interpret its content in accordance with generally accepted engineering or other professional standard and applicable regulations.

No recommendation as to products and services or vendors is made or should be implied.

No representation or warranty is made that this deliverable is technically accurate or sufficient or conforms to any law and/or governmental rule and/or regulation and further, no representation or warranty is made of merchantability or fitness for any particular purpose or against infringement of intellectual property rights.

In no event shall ETSI be held liable for loss of profits or any other incidental or consequential damages.

Any software contained in this deliverable is provided "AS IS" with no warranties, express or implied, including but not limited to, the warranties of merchantability, fitness for a particular purpose and non-infringement of intellectual property rights and ETSI shall not be held liable in any event for any damages whatsoever (including, without limitation, damages for loss of profits, business interruption, loss of information, or any other pecuniary loss) arising out of or related to the use of or inability to use the software.

Copyright Notification

No part may be reproduced or utilized in any form or by any means, electronic or mechanical, including photocopying and microfilm except as authorized by written permission of ETSI.

The content of the PDF version shall not be modified without the written authorization of ETSI.

The copyright and the foregoing restriction extend to reproduction in all media.

© ETSI 2025.
All rights reserved.

Intellectual Property Rights

Essential patents

IPRs essential or potentially essential to normative deliverables may have been declared to ETSI. The declarations pertaining to these essential IPRs, if any, are publicly available for **ETSI members and non-members**, and can be found in ETSI SR 000 314: *"Intellectual Property Rights (IPRs); Essential, or potentially Essential, IPRs notified to ETSI in respect of ETSI standards"*, which is available from the ETSI Secretariat. Latest updates are available on the [ETSI IPR online database](#).

Pursuant to the ETSI Directives including the ETSI IPR Policy, no investigation regarding the essentiality of IPRs, including IPR searches, has been carried out by ETSI. No guarantee can be given as to the existence of other IPRs not referenced in ETSI SR 000 314 (or the updates on the ETSI Web server) which are, or may be, or may become, essential to the present document.

Trademarks

The present document may include trademarks and/or tradenames which are asserted and/or registered by their owners. ETSI claims no ownership of these except for any which are indicated as being the property of ETSI, and conveys no right to use or reproduce any trademark and/or tradename. Mention of those trademarks in the present document does not constitute an endorsement by ETSI of products, services or organizations associated with those trademarks.

DECT™, **PLUGTESTS™**, **UMTS™** and the ETSI logo are trademarks of ETSI registered for the benefit of its Members. **3GPP™**, **LTE™** and **5G™** logo are trademarks of ETSI registered for the benefit of its Members and of the 3GPP Organizational Partners. **oneM2M™** logo is a trademark of ETSI registered for the benefit of its Members and of the oneM2M Partners. **GSM®** and the GSM logo are trademarks registered and owned by the GSM Association.

Legal Notice

This Technical Specification (TS) has been produced by ETSI 3rd Generation Partnership Project (3GPP).

The present document may refer to technical specifications or reports using their 3GPP identities. These shall be interpreted as being references to the corresponding ETSI deliverables.

The cross reference between 3GPP and ETSI identities can be found at [3GPP to ETSI numbering cross-referencing](#).

Modal verbs terminology

In the present document "**shall**", "**shall not**", "**should**", "**should not**", "**may**", "**need not**", "**will**", "**will not**", "**can**" and "**cannot**" are to be interpreted as described in clause 3.2 of the [ETSI Drafting Rules](#) (Verbal forms for the expression of provisions).

"**must**" and "**must not**" are **NOT** allowed in ETSI deliverables except when used in direct citation.

Contents

Intellectual Property Rights	2
Legal Notice	2
Modal verbs terminology.....	2
Foreword.....	6
1 Scope	8
2 References	8
3 Definitions of terms, symbols, and abbreviations	9
3.1 Terms.....	9
3.2 Symbols.....	9
3.3 Abbreviations	9
4 General	10
4.1 Relationship between minimum requirements and test requirements	10
4.2 Applicability of minimum requirements	10
4.2.1 General.....	10
4.2.1 UE mechanical modes	10
4.3 Applicability rules for testing of FR1 SA and NSA UEs	10
4.4 Applicability rules for testing of power class capability of UEs	11
5 Frequency Bands	11
5.1 General	11
5.2 Operating Bands	11
5.2.1 FR1 Standalone Operating bands.....	11
5.2.2 FR1 EN-DC band combinations	12
5.3 Test parameters for each band.....	14
6 FR1 Transmitter (TRP) Performance	18
6.1 General	18
6.2 TRP Performance for Handheld UE.....	19
6.2.1 TRP Performance for Handheld UE for FR1 (NR SA and EN-DC).....	19
6.2.1.1 Total Radiated Power (TRP) in Browsing Mode with Hand Phantom	19
6.2.1.1.1 Total Radiated Power (TRP) for FR1 NR Standalone (SA) in Browsing Mode with Hand Phantom.....	19
6.2.1.2 Total Radiated Power (TRP) in Talk Mode with Head and Hand Phantom.....	22
6.2.1.2.1 Total Radiated Power (TRP) for FR1 NR Standalone (SA) in Talk Mode with Head and Hand Phantom	22
7 FR1 Receiver (TRS) Performance	24
7.1 General	24
7.2 TRS Performance for Handheld UE.....	24
7.2.1 TRS Performance for Handheld UE for FR1 (NR SA and EN-DC).....	24
7.2.1.1 Total Radiated Sensitivity (TRS) in Browsing Mode with Hand Phantom.....	24
7.2.1.1.1 Total Radiated Sensitivity (TRS) for FR1 NR Standalone (SA) in Browsing Mode with Hand Phantom.....	24
7.2.1.2 Total Radiated Sensitivity (TRS) in Talk Mode with Head and Hand Phantom.....	27
7.2.1.2.1 Total Radiated Sensitivity (TRS) for FR1 NR Standalone (SA) in Talk Mode with Head and Hand Phantom	27
Annex A (normative): Test methodology	29
A.1 General	29
A.2 UE configuration	29
A.2.1 General	29
A.2.2 UE configuration for TRP test.....	29
A.2.3 UE configuration for TRS test.....	29

A.3	Test system of Anechoic Chamber method.....	30
A.3.1	System setup.....	30
A.3.2	Calibration procedure.....	30
A.3.3	Test procedure.....	31
A.3.3.1	General.....	31
A.3.3.2	TRP Test procedure.....	31
A.3.3.3	TRS Test procedure.....	32
A.3.3.3.1	Alternate EIS Search Procedure.....	32
A.3.3.3.1.1	EIS linearization using polynomial interpolation.....	32
A.3.4	Minimum Range Length.....	33
A.3.5	Definition of TRP and TRS for AC.....	35
A.3.5.1	Total Radiated Power (TRP).....	35
A.3.5.2	Total Radiated Sensitivity (TRS).....	36
A.3.6	TAS OFF verification procedure (Informative).....	36
A.3.7	Ripple test for Quiet Zone.....	37
A.3.7.1	General.....	37
A.3.7.2	Ripple test procedure.....	37
A.4	(Informative): Estimation of measurement uncertainty.....	41
A.4.1	General.....	41
A.4.2	Measurement uncertainty contribution descriptions.....	42
A.4.2.1	Mismatch uncertainty.....	42
A.4.2.1.1	Mismatch uncertainty between measurement receiver / communication tester and the measurement antenna.....	42
A.4.2.1.1.1	Mismatch uncertainty through the connector between two elements.....	43
A.4.2.1.1.2	Mismatch uncertainty due to the interaction of several elements.....	43
A.4.2.1.1.3	Total combined mismatch uncertainty.....	44
A.4.2.1.2	Mismatch uncertainty of the RF relay.....	45
A.4.2.1.2.1	First part: RF Relay switched on the co-polarized signal.....	45
A.4.2.1.2.1.1	The mismatch through the connector between two elements.....	45
A.4.2.1.2.1.2	Mismatch due to the interaction between two elements or more.....	46
A.4.2.1.2.2	Second part: RF relay switched on the cross-polarized signal.....	46
A.4.2.1.2.2.1	The mismatch through the connector between two elements.....	46
A.4.2.1.2.2.2	Mismatch due to the interaction between two elements or more.....	46
A.4.2.1.2.3	Total combined mismatch uncertainty.....	47
A.4.2.2	Insertion loss.....	47
A.4.2.2.1	Insertion loss of the measurement antenna cable.....	47
A.4.2.2.2	Insertion loss of the measurement antenna attenuator (if used).....	47
A.4.2.2.3	Insertion loss of the RF relays (if used).....	47
A.4.2.2.4	Insertion loss: calibration antenna feed cable.....	47
A.4.2.2.5	Insertion loss: calibration antenna attenuator (if used).....	48
A.4.2.3	Influence of the antenna cable.....	48
A.4.2.3.1	Measurement antenna cable.....	48
A.4.2.3.2	Calibration antenna cable.....	48
A.4.2.4	Measurement receiver: uncertainty of the absolute level.....	48
A.4.2.5	Communication tester: uncertainty of the absolute level.....	48
A.4.2.6	Sensitivity measurement: output level step resolution.....	48
A.4.2.7	Measurement distance.....	49
A.4.2.7.1	Offset of phase centre from axis(es) of rotation.....	49
A.4.2.7.1.1	Offset of DUT phase centre from axis(es) of rotation.....	49
A.4.2.7.1.2	Offset of calibration antenna phase centre from axis(es) of rotation.....	49
A.4.2.7.2	Mutual coupling.....	50
A.4.2.7.3	Phase curvature.....	50
A.4.2.8	Quality of quiet zone.....	50
A.4.2.9	DUT Tx-power drift.....	51
A.4.2.10	DUT sensitivity drift.....	51
A.4.2.11	Uncertainty related to the use of phantoms.....	51
A.4.2.11.1	Uncertainty from using different types of SAM phantom.....	52
A.4.2.11.2	Simulated tissue liquid uncertainty.....	52
A.4.2.11.3	Uncertainty of dielectric properties and shape of the hand phantom.....	52
A.4.2.11.4	Uncertainty from using different types of Laptop Ground Plane phantom.....	53
A.4.2.11.5	Positioning Uncertainty from using Phantoms.....	53

A.4.2.12	Coarse sampling grid	54
A.4.2.13	Random uncertainty	54
A.4.2.14	Frequency response.....	55
A.4.2.15	Uncertainty of network analyser	55
A.4.2.16	Uncertainty of the gain/efficiency of the calibration antenna	55
A.4.3	Total Radiated Power (TRP)	55
A.4.3.1	Anechoic Chamber Method	55
A.4.4	Total Radiated Sensitivity (TRS)	58
A.4.4.1	Anechoic Chamber Method	58
Annex B (normative): Phantoms definition and Positioning		62
B.1	General	62
B.2	Phantom Definition	62
B.2.1	Head Phantom	62
B.2.2	PDA Grip Hand Phantom.....	62
B.2.3	Wide Grip Hand Phantom	62
B.2.4	Forearm Phantom	63
B.3	UE positioning guidelines	63
B.3.1	Hand phantom only (Browsing mode)	63
B.3.1.1	Wide Grip Hand.....	64
B.3.1.2	PDA Grip Hand	64
B.3.2	Head and Hand phantom (Talk Mode)	65
B.3.2.1	General.....	65
B.3.2.2	Wide Grip Hand and Head.....	67
B.3.2.1	PDA Grip Hand and Head	67
B.3.3	Forearm phantom (Wrist-worn Mode)	67
B.3.2.1	General.....	67
B.3.2.2	Forearm phantom positioning in the chamber	67
B.3.2.3	Wrist-Worn RedCap Device mounted on the Forearm Phantom.....	67
Annex C (normative): Environmental requirements.....		69
C.1	General	69
C.2	Environmental	69
C.2.1	Temperature	69
C.2.2	Voltage	69
Annex D (normative): Maximum uncertainty of test system and test tolerance.....		70
D.1	Maximum uncertainty of test system	70
D.2	Test Tolerances	70
Annex E (informative): Change History		71
History		72

Foreword

This Technical Specification has been produced by the 3rd Generation Partnership Project (3GPP).

The contents of the present document are subject to continuing work within the TSG and may change following formal TSG approval. Should the TSG modify the contents of the present document, it will be re-released by the TSG with an identifying change of release date and an increase in version number as follows:

Version x.y.z

where:

x the first digit:

1 presented to TSG for information;

2 presented to TSG for approval;

3 or greater indicates TSG approved document under change control.

y the second digit is incremented for all changes of substance, i.e. technical enhancements, corrections, updates, etc.

z the third digit is incremented when editorial only changes have been incorporated in the document.

In the present document, modal verbs have the following meanings:

shall indicates a mandatory requirement to do something

shall not indicates an interdiction (prohibition) to do something

The constructions "shall" and "shall not" are confined to the context of normative provisions, and do not appear in Technical Reports.

The constructions "must" and "must not" are not used as substitutes for "shall" and "shall not". Their use is avoided insofar as possible, and they are not used in a normative context except in a direct citation from an external, referenced, non-3GPP document, or so as to maintain continuity of style when extending or modifying the provisions of such a referenced document.

should indicates a recommendation to do something

should not indicates a recommendation not to do something

may indicates permission to do something

need not indicates permission not to do something

The construction "may not" is ambiguous and is not used in normative elements. The unambiguous constructions "might not" or "shall not" are used instead, depending upon the meaning intended.

can indicates that something is possible

cannot indicates that something is impossible

The constructions "can" and "cannot" are not substitutes for "may" and "need not".

will indicates that something is certain or expected to happen as a result of action taken by an agency the behaviour of which is outside the scope of the present document

will not indicates that something is certain or expected not to happen as a result of action taken by an agency the behaviour of which is outside the scope of the present document

might indicates a likelihood that something will happen as a result of action taken by some agency the behaviour of which is outside the scope of the present document

might not indicates a likelihood that something will not happen as a result of action taken by some agency the behaviour of which is outside the scope of the present document

In addition:

is (or any other verb in the indicative mood) indicates a statement of fact

is not (or any other negative verb in the indicative mood) indicates a statement of fact

The constructions "is" and "is not" do not indicate requirements.

1 Scope

The present document specifies details of conformance testing of UE TRP (Total Radiated Power) and TRS (Total Radiated Sensitivity) requirements and test methodologies for FR1 (NR SA and EN-DC).

2 References

The following documents contain provisions which, through reference in this text, constitute provisions of the present document.

References are either specific (identified by date of publication, edition number, version number, etc.) or non-specific.

For a specific reference, subsequent revisions do not apply.

For a non-specific reference, the latest version applies. In the case of a reference to a 3GPP document (including a GSM document), a non-specific reference implicitly refers to the latest version of that document in the same Release as the present document.

- [1] 3GPP TS 38.161: "User Equipment (UE) TRP (Total Radiated Power) and TRS (Total Radiated Sensitivity) requirements; Range 1 Standalone and Range 1 Interworking operation with other radios
- [2] 3GPP TS 38.508-1: "5GS; User Equipment (UE) conformance specification; Part 1: Common test environment "
- [3] 3GPP TS 38.101-1: "NR; User Equipment (UE) radio transmission and reception; Part 1: Range 1 Standalone".
- [4] JCGM 100:2008: "Evaluation of measurement data — Guide to the expression of uncertainty in measurement".
- [5] ETSI TR 102 273-1-1: "Electromagnetic compatibility and Radio spectrum Matters (ERM); Improvement on Radiated Methods of Measurement (using test site) and evaluation of the corresponding measurement uncertainties; Part 1: Uncertainties in the measurement of mobile radio equipment characteristics; Sub-part 1: Introduction".
- [6] ETSI TR 100 028-2: "ElectroMagnetic Compatibility and Radio Spectrum Matters (ERM); Uncertainties in the measurement of mobile radio equipment characteristics; Part 2".
- [7] ETSI TR 102 273-1-2: "Electromagnetic compatibility and Radio spectrum Matters (ERM); Improvement on Radiated Methods of Measurement (using test site) and evaluation of the corresponding measurement uncertainties; Part 1: Uncertainties in the measurement of mobile radio equipment characteristics; Sub-part 2: Examples and annexes".
- [8] CTIA Certification™: "CTIA Certification Test Plan for Wireless Device Over-the-Air Performance, CTIA 01.70: Measurement Uncertainty", latest active version available at: <https://ctiacertification.org/test-plans/>
- [9] Foegelle, M.D., "The Surface Standard Deviation Method for TRP Measurement Uncertainty", 25th Proceedings of the Antenna Measurement Techniques Association (AMTA 2003), A03-027
- [10] 3GPP TR 38.834: "Measurements of User Equipment (UE) Over-the-Air (OTA) performance for NR FR1; Total Radiated Power (TRP) and Total Radiated Sensitivity (TRS) test methodology (Release 17)"
- [11] 3GPP TS 38.521-1: "NR; User Equipment (UE) conformance specification; Radio transmission and reception; Part 1: Range 1 Standalone"
- [12] CTIA Certification™: "CTIA Certification Test Plan for Wireless Device Over-the-Air Performance, CTIA 01.72: Near-Field Phantoms", latest active version available at: <https://ctiacertification.org/test-plans/>

- [13] CTIA Certification™: “CTIA Certification Test Plan for Wireless Device Over-the-Air Performance, CTIA 01.71 Device Setup and Positioning Guidelines”, latest active version available at: <https://ctiacertification.org/test-plans/>
- [14] 3GPP TS 38.521-3: "NR; User Equipment (UE) conformance specification; Radio transmission and reception; Part 3: Range 1 and Range 2 Interworking operation with other radios"
- [15] 3GPP TS 37.544: "Universal Terrestrial Radio Access (UTRA) and Evolved UTRA (E-UTRA); User Equipment (UE) Over The Air (OTA) performance; Conformance testing"
- [16] 3GPP TS 21.905: “Vocabulary for 3GPP Specifications”
- [17] 3GPP TS 38.101-3: “NR; User Equipment (UE) radio transmission and reception; Part 3: Range 1 and Range 2 Interworking operation with other radios”

3 Definitions of terms, symbols, and abbreviations

3.1 Terms

For the purposes of the present document, the terms given in 3GPP TR 21.905 [16] and the following apply. A term defined in the present document takes precedence over the definition of the same term, if any, in 3GPP TR 21.905 [1].

Browsing mode usage: This mode corresponds to “data” mode, the device is tested via hand-only phantoms.

Primary mechanical mode: The mode that is most often used for a specific user scenario. Every terminal has at least one primary mechanical mode, if multiple modes are supported, different primary mechanical modes may be applicable for different user scenarios, e.g., different primary mechanical modes for Browsing mode usage and Talk mode usage for the same UE.

Talk mode usage: This mode corresponds to “talk” mode, the device is tested via head & hand phantoms.

Wrist-worn mode usage: This mode corresponds to wearable device for wrist-worn mode, the device is tested via forearm phantoms.

3.2 Symbols

For the purposes of the present document, the following symbols apply:

$TRP_{average}$	The average measured total radiated power of low, mid and high channel. When hand phantom is involved, the average is performed with low, mid and high channel from both hand left and hand right.
$TRS_{average}$	The average measured total radiated sensitivity of low, mid and high channel. When hand phantom is involved, the average is performed with low, mid and high channel from both hand left and hand right.

3.3 Abbreviations

For the purposes of the present document, the abbreviations given in 3GPP TR 21.905 [1] and the following apply. An abbreviation defined in the present document takes precedence over the definition of the same abbreviation, if any, in 3GPP TR 21.905 [1].

AC	Anechoic Chamber
BHHL	Beside Head and Hand Left Side (Head and Hand Phantom)
BHHR	Beside Head and Hand Right Side (Head and Hand Phantom)
CA	Carrier Aggregation
DUT	Device Under Test
E-UTRA	Evolved UTRA
EIRP	Effective Isotropic Radiated Power
EUT	Equipment Under Test
FR1	RF Frequency Range 1

FS	Free Space
HL	Hand Left (Hand Phantom Only)
HR	Hand Right (Hand Phantom Only)
MPR	Allowed maximum power reduction
NR	New Radio
NSA	Non-Standalone, a mode of operation where operation of another radio is assisted with another radio
OTA	Over The Air
QZ	Quiet Zone
RedCap	Reduced Capability
SA	Standalone
SS	System Simulator
TAA	Time-Averaging Algorithm
TAS	Transmit Antenna Switching
TRP	Total Radiated Power
TRS	Total Radiated Sensitivity
TxD	Tx Diversity
UE	User Equipment
UL MIMO	Uplink Multiple Antenna transmission

4 General

4.1 Relationship between minimum requirements and test requirements

The Minimum Requirements given in TS 38.161 [1] make no allowance for measurement uncertainty. This test specification will define test tolerances for FR1 TRP TRS. The test tolerances are used to relax the minimum requirements in TS 38.161 [1] to create test requirements.

4.2 Applicability of minimum requirements

4.2.1 General

The minimum requirements apply only to the corresponding primary mechanical mode of UE in the environmental conditions specified in Annex C.4.2.2.

4.2.1 UE mechanical modes

The mechanical modes of a device under test (DUT) are declared by the manufacturer. A DUT shall have at least one mechanical mode. If only one mode is supported, then this is defined as the primary. If multiple modes are supported, the manufacturer can declare different primary mechanical modes applicable for different user scenarios, e.g., different primary mechanical mode for Browsing mode usage and Talk mode usage for the same UE.

4.3 Applicability rules for testing of FR1 SA and NSA UEs

1. The applicability and test coverage rules for Non-Standalone (NSA) only capable devices shall include the following:
 - a) For each NR band supported by the device, test the UE in EN-DC mode using any one example configuration containing that NR band or configuration declaration decision tree as per recommended TRP/TRS test procedures in this specification.
2. The applicability and test coverage rules for Standalone (SA) and NSA (EN-DC) capable devices shall include the following:

- a) For each NR band in a device, test the UE in Standalone Mode as per the TRP/TRS test procedures in this specification.
- b) This shall also fulfil coverage for all EN-DC FR1 minimum performance requirements for that NR band and need not be retested in EN-DC mode.

4.4 Applicability rules for testing of power class capability of UEs

1. The applicability and test coverage rules for PC2 and PC3 UEs shall include the following:
 - a) For UEs that support PC2 in a given band: verify the requirement only with PC2 configuration
 - b) For UEs that only support PC3 in a given band: verify the requirement with PC3 configuration

NOTE 1: The test procedure and requirements in this version of the specification apply only for UEs based on 1 Tx configuration and are not applicable to UEs under TxD and UL MIMO configurations.

5 Frequency Bands

5.1 General

This clause contains the operating bands for both Standalone (SA) and Non-Standalone (NSA) operation in frequency range 1 (FR1) as well as the test parameters for each band.

5.2 Operating Bands

5.2.1 FR1 Standalone Operating bands

The requirements defined in this specification for FR1 standalone apply to the operating bands defined in Table 5.2.1-1.

Table 5.2.1-1: NR operating bands in FR1 standalone

NR operating band	Uplink (UL) <i>operating band</i> BS receive / UE transmit $F_{UL_low} - F_{UL_high}$	Downlink (DL) <i>operating band</i> BS transmit / UE receive $F_{DL_low} - F_{DL_high}$	Duplex Mode
-------------------------	---	---	----------------

n1	1920 MHz – 1980 MHz	2110 MHz – 2170 MHz	FDD
n2	1850 MHz – 1910 MHz	1930 MHz – 1990 MHz	FDD
n3	1710 MHz – 1785 MHz	1805 MHz – 1880 MHz	FDD
n5	824 MHz – 849 MHz	869 MHz – 894 MHz	FDD
n7	2500 MHz – 2570 MHz	2620 MHz – 2690 MHz	FDD
n8	880 MHz – 915 MHz	925 MHz – 960 MHz	FDD
n12	699 MHz – 716 MHz	729 MHz – 746 MHz	FDD
n14	788 MHz – 798 MHz	758 MHz – 768 MHz	FDD
n20	832 MHz – 862 MHz	791 MHz – 821 MHz	FDD
n25	1850 MHz – 1915 MHz	1930 MHz – 1995 MHz	FDD
n26	814 MHz – 849 MHz	859 MHz – 894 MHz	FDD
n28	703 MHz – 748 MHz	758 MHz – 803 MHz	FDD
n30	2305 MHz – 2315 MHz	2350 MHz – 2360 MHz	FDD
n34	2010 MHz – 2025 MHz	2010 MHz – 2025 MHz	TDD
n38	2570 MHz – 2620 MHz	2570 MHz – 2620 MHz	TDD
n39	1880 MHz – 1920 MHz	1880 MHz – 1920 MHz	TDD
n40	2300 MHz – 2400 MHz	2300 MHz – 2400 MHz	TDD
n41	2496 MHz – 2690 MHz	2496 MHz – 2690 MHz	TDD
n48	3550 MHz – 3700 MHz	3550 MHz – 3700 MHz	TDD
n50	1432 MHz – 1517 MHz	1432 MHz – 1517 MHz	TDD ¹
n51	1427 MHz – 1432 MHz	1427 MHz – 1432 MHz	TDD
n53	2483.5 MHz – 2495 MHz	2483.5 MHz – 2495 MHz	TDD
n65	1920 MHz – 2010 MHz	2110 MHz – 2200 MHz	FDD ⁴
n66	1710 MHz – 1780 MHz	2110 MHz – 2200 MHz	FDD
n70	1695 MHz – 1710 MHz	1995 MHz – 2020 MHz	FDD
n71	663 MHz – 698 MHz	617 MHz – 652 MHz	FDD
n74	1427 MHz – 1470 MHz	1475 MHz – 1518 MHz	FDD
n75	N/A	1432 MHz – 1517 MHz	SDL
n76	N/A	1427 MHz – 1432 MHz	SDL
n77 ¹²	3300 MHz – 4200 MHz	3300 MHz – 4200 MHz	TDD
n78	3300 MHz – 3800 MHz	3300 MHz – 3800 MHz	TDD
n79	4400 MHz – 5000 MHz	4400 MHz – 5000 MHz	TDD
n80	1710 MHz – 1785 MHz	N/A	SUL
n81	880 MHz – 915 MHz	N/A	SUL
n82	832 MHz – 862 MHz	N/A	SUL
n83	703 MHz – 748 MHz	N/A	SUL
n84	1920 MHz – 1980 MHz	N/A	SUL
n86	1710 MHz – 1780 MHz	N/A	SUL
n95	2010 MHz – 2025 MHz	N/A	SUL

Other operating bands may be considered in future releases.

5.2.2 FR1 EN-DC band combinations

Principle of EN-DC band combinations selection for FR1 TRP TRS OTA testing:

1. Focus on the performance of the NR carrier and do not consider multiple permutations between different LTE bands and NR band under test, i.e., for each NR band, only select one EN-DC band combination.
2. For UE supporting multiple EN-DC band combinations for the same NR band, consider only those EN-DC configurations which have no MSD impact on either LTE or NR, i.e., the selected EN-DC combination should be no MSD issue identified in TS 38.101-3 [17] Section 7.3B.2.3 (Inter-band EN-DC within FR1).

Table 5.2.2-1: Measurement parameters for example inter-band EN-DC band combinations (two bands)

EN-DC configuration	E-UTRA configurations	NR configurations
DC_3A_n28A	Note1	Note2
DC_2A_n41A	Note1	Note2
DC_1A_n78A	Note1	Note2
DC_1A_n79A	Note1	Note2
Note 1: As per TR 37.902 [10], Section 6.4 (Measurement frequencies).		
Note 2: As per Table 4.3.3-1 and Table 4.3.3-2 in TR 38.834.		

With the above basic principle and EN-DC example band combination, the selection logic for testing is defined by the decision tree below.

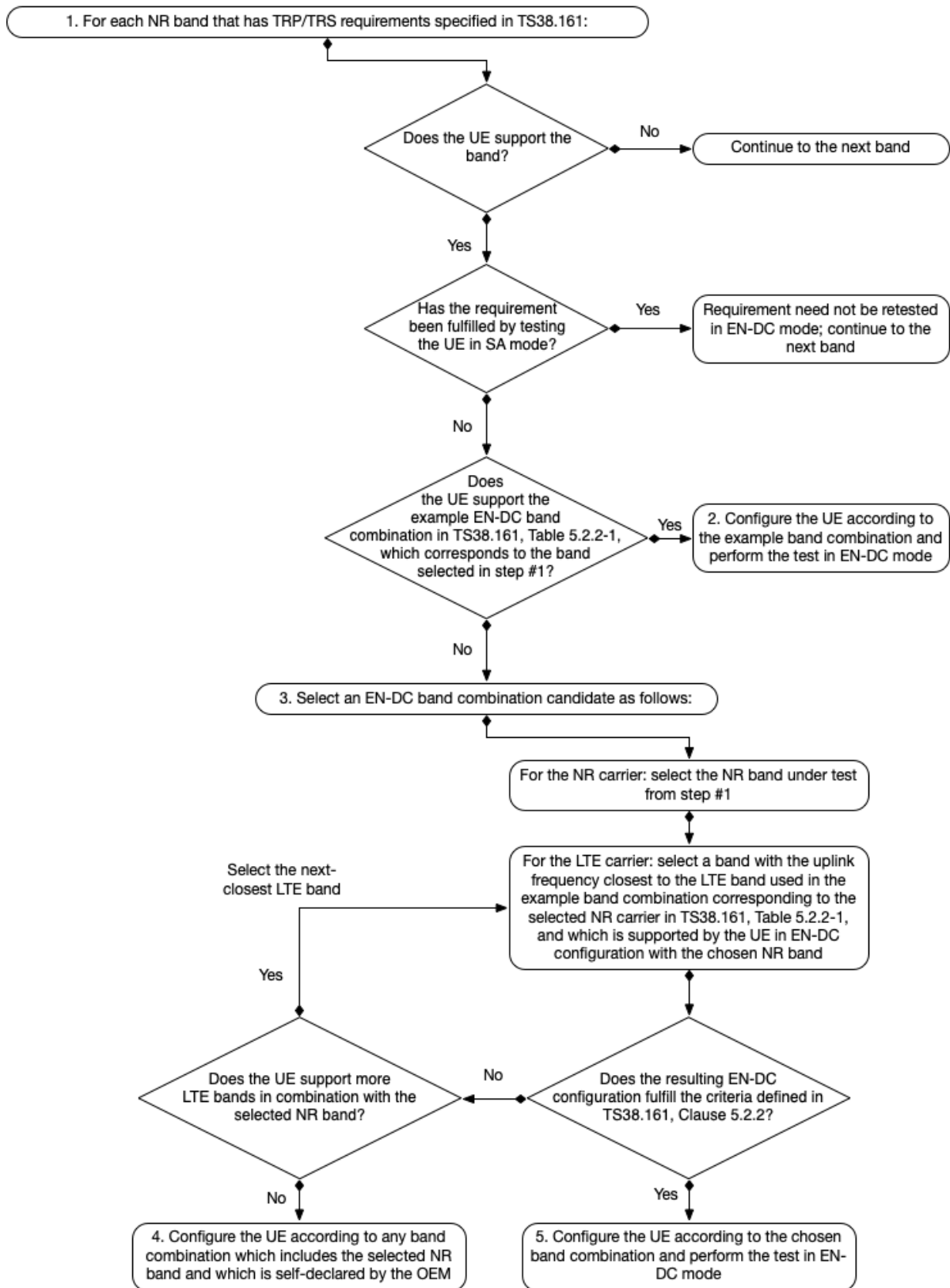

Figure 5.2.2-2: Decision tree to select the EN-DC band combination for TRP/TRS testing

5.3 Test parameters for each band

The detailed testing parameters for each band is defined in Table 5.3-1 and Table 5.3-2.

Table 5.3-1: NR FR1 TRP measurement parameters

NR Band	CBW [MHz]	SCS (kHz)	UL modulation	Range	UL Carrier centre [ARFCN]	UL Carrier Center (MHz)	DL Carrier centre [ARFCN]	DL Carrier Center (MHz)	UL RB Allocation (LCRB @ RB _{start})	DL configuration
n1	15	15	DFT-s-OFDM QPSK	Low	385500	1927.5	423500	2117.5	36@18	N/A
				Mid	390000	1950	428000	2140		
				High	394500	1972.5	432500	2162.5		
n2	15	15	DFT-s-OFDM QPSK	Low	371500	1857.5	387500	1937.5	36@18	N/A
				Mid	376000	1880	392000	1960		
				High	380500	1902.5	396500	1982.5		
n3	20	15	DFT-s-OFDM QPSK	Low	344000	1720	363000	1815	50@25	N/A
				Mid	349500	1747.5	368500	1842.5		
				High	355000	1775	374000	1870		
n5	15	15	DFT-s-OFDM QPSK	Low	166300	831.5	175300	876.5	36@18	N/A
				Mid	167300	836.5	176300	881.5		
				High	168300	841.5	177300	886.5		
n7	15	15	DFT-s-OFDM QPSK	Low	501500	2507.5	525500	2627.5	36@18	N/A
				Mid	507000	2535	531000	2655		
				High	512500	2562.5	536500	2682.5		
n8	15	15	DFT-s-OFDM QPSK	Low	177500	887.5	186500	932.5	36@18	N/A
				Mid	179500	897.5	188500	942.5		
				High	181500	907.5	190500	952.5		
n12	10	15	DFT-s-OFDM QPSK	Low	140800	704	146800	734	25@12	N/A
				Mid	141500	707.5	147500	737.5		
				High	142200	711	148200	741		
n14	10	15	DFT-s-OFDM QPSK	Low	158600	793	152600	763	25@12	N/A
				Mid						
				High						
n20	15	15	DFT-s-OFDM QPSK	Low	167900	839.5	159700	798.5	36@18	N/A
				Mid	169400	847	161200	806		
				High	170900	854.5	162700	813.5		
n25	15	15	DFT-s-OFDM QPSK	Low	371500	1857.5	387500	1937.5	36@18	N/A
				Mid	376500	1882.5	392500	1962.5		
				High	381500	1907.5	397500	1987.5		
n26	10	15	DFT-s-OFDM QPSK	Low	163800	819	172800	864	25@12	N/A
				Mid	166300	831.5	175300	876.5		
				High	168800	844	177800	889		
n28	20	15	DFT-s-OFDM QPSK	Low	142600	713	153600	768	50@25	N/A
				Mid	145600	728	156600	783		
				High	147600	738	158600	793		
n30	10	15	DFT-s-OFDM QPSK	Low	462000	2310	471000	2355	25@12	N/A
				Mid						
				High						
n34	10	15	DFT-s-OFDM QPSK	Low	403000	2015	403000	2015	25@12	N/A
				Mid	403500	2017.5	403500	2017.5		
				High	404000	2020	404000	2020		
n38	15	15	DFT-s-OFDM QPSK	Low	515500	2577.5	515500	2577.5	36@18	N/A
				Mid	519000	2595	519000	2595		
				High	522500	2612.5	522500	2612.5		
n39	20	15	DFT-s-OFDM QPSK	Low	378000	1890	378000	1890	50@25	N/A
				Mid	380000	1900	380000	1900		
				High	382000	1910	382000	1910		
n40	30	15	DFT-s-OFDM QPSK	Low	463000	2315	463000	2315	[50@25]	N/A
				Mid	470000	2350	470000	2350		
				High	477000	2385	477000	2385		
n41	100	30	DFT-s-OFDM QPSK	Low	509202	2546.01	509202	2546.01	135@67	N/A
				Mid	518598	2592.99	518598	2592.99		
				High	528000	2640	528000	2640		
n48	20	15	DFT-s-OFDM QPSK	Low	637334	3560.01	637334	3560.01	50@25	N/A
				Mid	641666	3624.99	641666	3624.99		
				High	646000	3690	646000	3690		
n50	20	15	DFT-s-OFDM QPSK	Low	288400	1442	288400	1442	50@25	N/A
				Mid	294900	1474.5	294900	1474.5		
				High	301400	1507	301400	1507		

n51	5	15	DFT-s-OFDM QPSK	Low	285900	1429.5	285900	1429.5	12@6	N/A
				Mid						
				High						
n53	10	15	DFT-s-OFDM QPSK	Low	497700	2488.5	497700	2488.5	25@12	N/A
				Mid	497860	2489.3	497860	2489.3		
				High	498000	2490	498000	2490		
n65	15	15	DFT-s-OFDM QPSK	Low	423500	2117.5	423500	2117.5	36@18	N/A
				Mid	431000	2155	431000	2155		
				High	438500	2192.5	438500	2192.5		
n66	20 (20+20)	15	DFT-s-OFDM QPSK	Low	344000	1720	424000	2120	50@25	N/A
				Mid	349000	1745	429000	2145		
				High	354000	1770	434000	2170		
n70	15 (15+15)	15	DFT-s-OFDM QPSK	Low	340500	1702.5	400500	2002.5	36@18	N/A
				Mid						
				High						
n71	10	15	DFT-s-OFDM QPSK	Low	133600	668	124400	622	25@12	N/A
				Mid	136100	680.5	126900	634.5		
				High	138600	693	129400	647		
n74	15	15	DFT-s-OFDM QPSK	Low	286900	1434.5	296500	1482.5	36@18	N/A
				Mid	289700	1448.5	299300	1496.5		
				High	292500	1462.5	302100	1510.5		
n77	100	30	DFT-s-OFDM QPSK	Low	623334	3350.01	623334	3350.01	135@67	N/A
				Mid	650000	3750	650000	3750		
				High	676666	4149.99	676666	4149.99		
n78	100	30	DFT-s-OFDM QPSK	Low	623334	3350.01	623334	3350.01	135@67	N/A
				Mid	636666	3549.99	636666	3549.99		
				High	650000	3750	650000	3750		
n79	100	30	DFT-s-OFDM QPSK	Low	696668	4450.02	696668	4450.02	135@67	N/A
				Mid	713334	4700.01	713334	4700.01		
				High	730000	4950	730000	4950		
n80	20	15	DFT-s-OFDM QPSK	Low	344000	1720	N/A	N/A	50@25	N/A
				Mid	349500	1747.5	N/A	N/A		
				High	355000	1775	N/A	N/A		
n81	15	15	DFT-s-OFDM QPSK	Low	177500	887.5	N/A	N/A	36@18	N/A
				Mid	179500	897.5	N/A	N/A		
				High	181500	907.5	N/A	N/A		
n82	15	15	DFT-s-OFDM QPSK	Low	167900	839.5	N/A	N/A	36@18	N/A
				Mid	169400	847	N/A	N/A		
				High	170900	854.5	N/A	N/A		
n83	15	15	DFT-s-OFDM QPSK	Low	142100	710.5	N/A	N/A	36@18	N/A
				Mid	145100	725.5	N/A	N/A		
				High	148100	740.5	N/A	N/A		
n84	15	15	DFT-s-OFDM QPSK	Low	385500	1927.5	N/A	N/A	36@18	N/A
				Mid	390000	1950	N/A	N/A		
				High	394500	1972.5	N/A	N/A		
n86	20	15	DFT-s-OFDM QPSK	Low	344000	1720	N/A	N/A	50@25	N/A
				Mid	349000	1745	N/A	N/A		
				High	354000	1770	N/A	N/A		
N95	10	15	DFT-s-OFDM QPSK	Low	403000	2015	N/A	N/A	50@25	N/A
				Mid	403500	2017.5	N/A	N/A		
				High	404000	2020	N/A	N/A		

Table 5.3-2: NR FR1 TRS measurement parameters

NR Band	CBW (MHz)	SCS (kHz)	DL modulation	UL modulation	Range	UL Carrier centre [ARFCN]	UL Carrier Center (MHz)	DL Carrier centre [ARFCN]	DL Carrier Center (MHz)	UL RB Allocation (LCRB @ RB _{start})	DL Configuration (FULL RB, LCRB @ RB _{start})
n1	15	15	CP-OFDM QPSK	DFT-s-OFDM QPSK	Low	385500	1927.5	423500	2117.5	75@4	79@0
					Mid	390000	1950	428000	2140		
					High	394500	1972.5	432500	2162.5		
n2	15	15		DFT-s-OFDM	Low	371500	1857.5	387500	1937.5	50@29	79@0
					Mid	376000	1880	392000	1960		

			CP-OFDM QPSK	QPSK	High	380500	1902.5	396500	1982.5		
n3	20	15	CP-OFDM QPSK	DFT-s-OFDM QPSK	Low	344000	1720	363000	1815	50@56	106@0
					Mid	349500	1747.5	368500	1842.5		
					High	355000	1775	374000	1870		
n5	15	15	CP-OFDM QPSK	DFT-s-OFDM QPSK	Low	166300	831.5	175300	876.5	25@54	79@0
					Mid	167300	836.5	176300	881.5		
					High	168300	841.5	177300	886.5		
n7	15	15	CP-OFDM QPSK	DFT-s-OFDM QPSK	Low	501500	2507.5	525500	2627.5	75@4	79@0
					Mid	507000	2535	531000	2655		
					High	512500	2562.5	536500	2682.5		
n8	15	15	CP-OFDM QPSK	DFT-s-OFDM QPSK	Low	177500	887.5	186500	932.5	25@54	79@0
					Mid	179500	897.5	188500	942.5		
					High	181500	907.5	190500	952.5		
n12	10	15	CP-OFDM QPSK	DFT-s-OFDM QPSK	Low	140800	704	146800	734	20@32	52@0
					Mid	141500	707.5	147500	737.5		
					High	142200	711	148200	741		
n14	10	15	CP-OFDM QPSK	DFT-s-OFDM QPSK	Low	158600	793	152600	763	20@32	52@0
					Mid						
					High						
n20	15	15	CP-OFDM QPSK	DFT-s-OFDM QPSK	Low	167900	839.5	159700	798.5	20@11	79@0
					Mid	169400	847	161200	806		
					High	170900	854.5	162700	813.5		
n25	15	15	CP-OFDM QPSK	DFT-s-OFDM QPSK	Low	371500	1857.5	387500	1937.5	50@29	79@0
					Mid	376500	1882.5	392500	1962.5		
					High	381500	1907.5	397500	1987.5		
n26	10	15	CP-OFDM QPSK	DFT-s-OFDM QPSK	Low	163800	819	172800	864	25@27	52@0
					Mid	166300	831.5	175300	876.5		
					High	168800	844	177800	889		
n28	20	15	CP-OFDM QPSK	DFT-s-OFDM QPSK	Low	142600	713	153600	768	25@81	106@0
					Mid	145600	728	156600	783		
					High	147600	738	158600	793		
n30	10	15	CP-OFDM QPSK	DFT-s-OFDM QPSK	Low	462000	2310	471000	2355	20@32	52@0
					Mid						
					High						
n34	10	15	CP-OFDM QPSK	DFT-s-OFDM QPSK	Low	403000	2015	403000	2015	50@0	52@0
					Mid	403500	2017.5	403500	2017.5		
					High	404000	2020	404000	2020		
n38	15	15	CP-OFDM QPSK	DFT-s-OFDM QPSK	Low	515500	2577.5	515500	2577.5	75@0	79@0
					Mid	519000	2595	519000	2595		
					High	522500	2612.5	522500	2612.5		
n39	20	15	CP-OFDM QPSK	DFT-s-OFDM QPSK	Low	378000	1890	378000	1890	100@0	106@0
					Mid	380000	1900	380000	1900		
					High	382000	1910	382000	1910		
n40	30	15	CP-OFDM QPSK	DFT-s-OFDM QPSK	Low	463000	2315	463000	2315	160@0	160@0
					Mid	470000	2350	470000	2350		
					High	477000	2385	477000	2385		
n41	100	30	CP-OFDM QPSK	DFT-s-OFDM QPSK	Low	509202	2546.01	509202	2546.01	270@0	273@0
					Mid	518598	2592.99	518598	2592.99		
					High	528000	2640	528000	2640		
n48	20	15		DFT-s-OFDM	Low	637334	3560.01	637334	3560.01	100@0	106@0
					Mid	641666	3624.99	641666	3624.99		

			CP-OFDM QPSK	QPSK	High	646000	3690	646000	3690		
n50	20	15	CP-OFDM QPSK	DFT-s-OFDM QPSK	Low	288400	1442	288400	1442	100@0	106@0
					Mid	294900	1474.5	294900	1474.5		
					High	301400	1507	301400	1507		
n51	5	15	CP-OFDM QPSK	DFT-s-OFDM QPSK	Low	285900	1429.5	285900	1429.5	25@0	25@0
					Mid						
					High						
n53	10	15	CP-OFDM QPSK	DFT-s-OFDM QPSK	Low	497700	2488.5	497700	2488.5	50@0	52@0
					Mid	497860	2489.3	497860	2489.3		
					High	498000	2490	498000	2490		
n65	15	15	CP-OFDM QPSK	DFT-s-OFDM QPSK	Low	423500	2117.5	423500	2117.5	75@4	79@0
					Mid	431000	2155	431000	2155		
					High	438500	2192.5	438500	2192.5		
n66	20 (20+20)	15	CP-OFDM QPSK	DFT-s-OFDM QPSK	Low	344000	1720	424000	2120	100@6	106@0
					Mid	349000	1745	429000	2145		
					High	354000	1770	434000	2170		
n70	15	15	CP-OFDM QPSK	DFT-s-OFDM QPSK	Low	340500	1702.5	400500	2002.5	75@4	79@0
					Mid						
					High						
n71	10	15	CP-OFDM QPSK	DFT-s-OFDM QPSK	Low	133600	668	124400	622	25@0	52@0
					Mid	136100	680.5	126900	634.5		
					High	138600	693	129400	647		
n74	15	15	CP-OFDM QPSK	DFT-s-OFDM QPSK	Low	286900	1434.5	296500	1482.5	25@54	79@0
					Mid	289700	1448.5	299300	1496.5		
					High	292500	1462.5	302100	1510.5		
n75 SDL	15	15	CP-OFDM QPSK	DFT-s-OFDM QPSK	Low	N/A	N/A	287900	1439.5	NA	79@0
					Mid	N/A	N/A	294900	1474.5		
					High	N/A	N/A	301900	1509.5		
n76 SDL	5	15	CP-OFDM QPSK	DFT-s-OFDM QPSK	Low	N/A	N/A	285900	1429.5	NA	25@0
					Mid						
					High						
n77	100	30	CP-OFDM QPSK	DFT-s-OFDM QPSK	Low	623334	3350.01	623334	3350.01	270@0	273@0
					Mid	650000	3750	650000	3750		
					High	676666	4149.99	676666	4149.99		
n78	100	30	CP-OFDM QPSK	DFT-s-OFDM QPSK	Low	623334	3350.01	623334	3350.01	270@0	273@0
					Mid	636666	3549.99	636666	3549.99		
					High	650000	3750	650000	3750		
n79	100	30	CP-OFDM QPSK	DFT-s-OFDM QPSK	Low	696668	4450.02	696668	4450.02	270@0	273@0
					Mid	713334	4700.01	713334	4700.01		
					High	730000	4950	730000	4950		

6 FR1 Transmitter (TRP) Performance

6.1 General

The TRP requirements specified in this clause 6 apply to handheld UE with Transmit Antenna Switching (TAS) switched OFF and any power back-off functions disabled.

The TRP requirements defined in Clause 6.2 should be verified based on the detailed test parameters in Table 5.3-1.

6.2 TRP Performance for Handheld UE

6.2.1 TRP Performance for Handheld UE for FR1 (NR SA and EN-DC)

6.2.1.1 Total Radiated Power (TRP) in Browsing Mode with Hand Phantom

6.2.1.1.1 Total Radiated Power (TRP) for FR1 NR Standalone (SA) in Browsing Mode with Hand Phantom

6.2.1.1.1.1 Test Purpose

To verify that the total radiated power (TRP) of a 5G NR FR1 UE, in browsing mode with Hand phantom only, does not exceed the range prescribed by the specified nominal maximum output power and tolerance.

An excess maximum output power has the possibility to interfere to other channels or other systems. A small maximum output power decreases the coverage area.

6.2.1.1.1.2 Test applicability

This test case applies to all types of NR Power Class 2 and Power Class 3 UE Release 17 and forward that do not support Transmit Diversity.

6.2.1.1.1.3 Minimum conformance requirements

The average measured Total Radiated Power (TRP) of low, mid and high channel for handheld UE shall be higher than the average TRP requirement specified in subclauses 6.2.1.1 and 6.2.1.2. The averaging shall be done in linear scale for the TRP results of both right and left side of the phantom head in case of beside the head and hand phantom positions. For the hand phantom browsing mode position the averaging shall be done in linear scale for the TRP results of both right and left hand phantom measurements.

$$TRP_{average} = 10\log \left[\frac{10^{P_{left,low}/10} + 10^{P_{left,mid}/10} + 10^{P_{left,high}/10} + 10^{P_{right,low}/10} + 10^{P_{right,mid}/10} + 10^{P_{right,high}/10}}{6} \right]$$

For UEs which do not support NR FR1 in stand-alone mode, EN-DC mode requirements apply. SA and EN-DC test case applicability is defined in Clause 4.3, and test case applicability based on power class capability is defined in Clause 4.4. The relevant test methodology is defined in Annexes A and B of the present document.

6.2.1.1.1.3.1 Hand phantom browsing mode

Hand phantom browsing mode positions are defined in Clause B.3.1.

6.2.1.1.1.3.2 Minimum conformance requirements for NR FR1 in hand phantom browsing position

Handheld UE TRP minimum performance requirement for NR FR1 bands in the hand phantom browsing position and the primary mechanical mode are defined in Tables 6.2.1.1.1.3.2-1 and 6.2.1.1.1.3.2-2.

Table 6.2.1.1.1.3.2-1: Handheld PC3 UE TRP minimum performance requirement for NR FR1 bands in the hand phantom browsing position and the primary mechanical mode

NR Band	Bandwidth (MHz)	Usage Scenario	Power Class 3	
			Average TRP (dBm)	
			UE width ≤ 72mm	UE width > 72mm
n1	15	HL and HR		11.6
n28	20	HL and HR		101
n41	100	HL and HR		9.5
n78	100	HL and HR		10
n79	100	HL and HR		

NOTE 1: 0.5dB higher value will be adopted in March 2026 (RAN#111) in the core specifications.

Table 6.2.1.1.1.3.2-2: Handheld PC2 UE TRP minimum performance requirement for NR FR1 bands in the hand phantom browsing position and the primary mechanical mode

NR Band	Bandwidth (MHz)	Usage Scenario	Power Class 2	
			Average TRP (dBm)	
			UE width ≤ 72mm	UE width > 72mm
n28	20	HL and HR		
n41	100	HL and HR		12.5
n78	100	HL and HR		13
n79	100	HL and HR		

The normative reference for this requirement is TS 38.161 [1] clause 6.2.1.1.1.

6.2.1.1.1.4 Test description

6.2.1.1.1.4.1 Initial conditions

Initial conditions are a set of test configurations the UE needs to be tested in and the steps for the SS to take with the UE to reach the correct measurement state.

The initial test configurations consist of environmental conditions, test frequencies, test channel bandwidths and sub-carrier spacing based on NR operating bands specified in table 5.2.1-1. All of these configurations shall be tested with applicable test parameters for each combination of test channel bandwidth and sub-carrier spacing and are shown in table 5.3-1. The details of the uplink reference measurement channels (RMCs) mainly comprising the uplink modulation and uplink RB allocation are also specified in Table 5.3-1. Configurations of PDSCH and PDCCH before measurement are specified in Annex A.0

The following steps are recommended as per TR 38.834 [10]:

- P-MPRc shall be 0 dB.
 - FR1 TRP radiated conformance testing shall be performed with the UE consistently operating at maximum power level, e.g., Time-Averaged Algorithm (TAA) and other power back-off functions should be disabled. The above functions being OFF should be based on manufacturer declaration; if declared, then the manufacturer is required to provide a mechanism for the test lab to enable/disable the function.
 - The NR SS should send continuous uplink power control “up” commands to the DUT to ensure the DUT’s transmitter is at maximum output power during the SA TRP and TRS test.
 - It is recommended to disable Transmit Antenna Switching (TAS) as per the procedure defined in Annex A.3.6
1. For DUT containing multiple Tx antennas, it shall be ensured that the Tx Antenna Switching (TAS) function should be OFF, and the TRP should be measured for each Tx antenna individually.

NOTE: The primary antenna should be selected based on manufacturer declaration. In the absence of manufacturer declaration, the antenna with better TRP is identified as the primary antenna, and the corresponding TRP result will be used to determine the pass/fail compliance.

2. Connect the SS to the UE antenna connectors as shown in TS 38.508-1 [2] Annex A, Figure A.3.1.1.1 for TE diagram and section A.3.2 for UE diagram.

3. The parameter settings for the cell are set up according to TS 38.508-1 [2] subclause 4.4.3.
4. Downlink signals are initially set up according to Annex C in TS 38.521-1 [11] and uplink signals according to Annex G in TS. 38.521-1 [11].
5. The UL and DL parameters are set according to Table 5.3-1.
6. Propagation conditions are set to Static.
7. Ensure the UE is in state RRC_CONNECTED with generic procedure parameters Connectivity NR, Connected without release On, Test Mode On and Test Loop Function On according to TS 38.508-1 [2] clause 4.5. Message contents are defined in clause 6.2.1.4.3.

6.2.1.1.1.4.2 Test procedure

For TRP measurement, the evaluations shall be performed at maximum transmit power. The applicability rules for testing of UE power class in clause 4.4 shall be followed. The measurement procedure includes the following steps:

1. Place the DUT inside the QZ following the UE positioning guidelines defined in Annex B.3.1.
2. SS sends uplink scheduling information for each UL HARQ process via PDCCH DCI format 0_1 for C_RNTI to schedule the UL RMC according to Table 5.3-1. For any additional RMC parameters beyond Table 5.3-2, refer to Table 6.2.1.4.1-1 of TS 38.521-1 [11]. Since the UE has no payload and no loopback data to send the UE sends uplink MAC padding bits on the UL RMC.
3. Ensure the DUT transmits with its maximum power by continuously sending uplink power control "up" commands in every uplink scheduling information to the UE; allow at least 200ms starting from the first TPC command in this step for the UE to reach PUMAX level.
4. The TRP of the DUT is measured by sampling the radiated transmit power of the DUT with three-dimensional scan at various locations surrounding the device. Measure the power at each measurement point, and calculate $EIRP(\theta, \phi)$ by adding the composite loss of the entire transmission path.
5. The measurement is performed with a constant sampling step in both theta (θ) and phi (ϕ) axes using any of the measurement grids and quadrature options outlined and applicable to TRP in Table A.4.2.12-1. Any of the measurement grids in Table A.4.2.12-1 could be used for testing. Measurements at theta = 0 and 180 degrees only require one measurement each. For test systems that cannot measure 180° EIRP, an extrapolation approach shall be adopted when generating the 3D antenna pattern and calculating TRP.
6. All the measured power values will be integrated to TRP, as defined in Annex A.3.5.1 with the procedure further detailed in A.3.3.2.

6.2.1.1.1.4.3 Message contents

Message contents are according to TS 38.508-1 [5] subclause 4.6 and 5.4 with the following exceptions.

Table 6.2.1.1.1.4.3-1: PUSCH-Config

Derivation Path: TS 38.508-1 [5], Table 4.6.3-118 with condition TRANSFORM_PRECODER_ENABLED
--

6.2.1.1.1.5 Test requirement

The TRP across low, mid and high channels tested with hand phantom browsing mode position shall be higher than test performance requirements shown in Table 6.2.1.1.1.5-1 for Power Class 3 and 6.2.1.1.1.5-2 for Power Class 2.

Table 6.2.1.1.1.5-1: Handheld PC3 UE TRP test requirements for NR FR1 bands in the hand phantom browsing position and the primary mechanical mode

NR Band	Bandwidth (MHz)	Usage Scenario	Power Class 3	
			Average TRP (dBm)	
			UE width ≤ 72mm	UE width > 72mm
n1	15	HL and HR	FFS	11.6-TT
n28	20	HL and HR	FFS	10 ¹ -TT
n41	100	HL and HR	FFS	9.5-TT
n78	100	HL and HR	FFS	10-TT
n79	100	HL and HR	FFS	FFS

NOTE 1: 0.5dB higher value will be adopted in March 2026 (RAN#111) in the core specifications.

Table 6.2.1.1.1.5-2: Handheld PC2 UE TRP test requirements for NR FR1 bands in the hand phantom browsing position and the primary mechanical mode

NR Band	Bandwidth (MHz)	Usage Scenario	Power Class 2	
			Average TRP (dBm)	
			UE width ≤ 72mm	UE width > 72mm
n28	20	HL and HR	FFS	FFS
n41	100	HL and HR	FFS	12.5-TT
n78	100	HL and HR	FFS	13-TT
n79	100	HL and HR	FFS	FFS

Table 6.2.1.1.1.5-3: Test Tolerance (NR FR1 TRP)

Operating band	Test Tolerance (dB)
n1	1.02
n28	1.02
n41	1.02
n78	1.07

6.2.1.2 Total Radiated Power (TRP) in Talk Mode with Head and Hand Phantom

6.2.1.2.1 Total Radiated Power (TRP) for FR1 NR Standalone (SA) in Talk Mode with Head and Hand Phantom

Editor's note: This clause is incomplete:

- Test Applicability is pending

- Test Procedure, Message Contents and Test Requirements are pending.

- MU and TT are pending.

6.2.1.2.1.1 Test purpose

To verify that the total radiated power (TRP) of a 5G NR FR1 UE in talk mode with head and hand phantom does not exceed the range prescribed by the specified nominal maximum output power and tolerance.

An excess maximum output power has the possibility to interfere to other channels or other systems. A small maximum output power decreases the coverage area.

6.2.1.2.1.2 Test applicability

FFS

6.2.1.2.1.3 Minimum conformance requirements

Handheld UE TRP minimum performance requirement for NR FR1 bands in the beside head and hand phantom talk position and the primary mechanical mode are defined in Tables 6.2.1.2.1-1 and 6.2.1.2.1-2.

Table 6.2.1.2.1-1: Handheld PC3 UE TRP minimum performance requirement for NR FR1 bands in the beside head and hand phantom talk position and the primary mechanical mode

NR Band	Bandwidth (MHz)	Usage Scenario	Power Class 3	
			Average TRP (dBm)	
			UE width \leq 72mm	UE width $>$ 72mm
n1	15	BHHL and BHHR		10.6
n28	20	BHHL and BHHR		7.2 ¹
n41	100	BHHL and BHHR		
n78	100	BHHL and BHHR		
n79	100	BHHL and BHHR		

NOTE 1: 0.4dB higher value will be adopted in March 2026 (RAN#111) in the core specifications.

Table 6.2.1.2.1-2: Handheld PC2 UE TRP minimum performance requirement for NR FR1 bands in the beside head and hand phantom talk position and the primary mechanical mode

NR Band	Bandwidth (MHz)	Usage Scenario	Power Class 2	
			Average TRP (dBm)	
			UE width \leq 72mm	UE width $>$ 72mm
n1	15	BHHL and BHHR		
n28	20	BHHL and BHHR		
n41	100	BHHL and BHHR		10
n78	100	BHHL and BHHR		11.5 ¹
n79	100	BHHL and BHHR		

NOTE 1: 0.5dB higher value will be adopted in March 2026 (RAN#111) in the core specifications.

6.2.1.2.1.3.1 Head and Hand phantom browsing mode

Hand phantom browsing mode positions are defined in Clause B.3.1.

6.2.1.2.1.3.2 Minimum conformance requirements for NR FR1 in head and hand phantom talk mode position

FFS

6.2.1.2.1.4 Test description

FFS

6.2.1.2.1.4.2 Test procedure

FFS

6.2.1.2.1.4.3 Message contents

FFS

6.2.1.2.1.5 Test requirement

Editor's note: This sub-clause is in the scope of Release 18

7 FR1 Receiver (TRS) Performance

7.1 General

The TRS requirements specified in this clause 7 apply to handheld UE configured with maximum number of Rx antennas supported for each band, which is specified in TS 38.101-1 Clause 7.3 [3].

The TRS requirements defined in Clause 7.2 should be verified based on the detailed test parameters in Table 5.3-2.

7.2 TRS Performance for Handheld UE

7.2.1 TRS Performance for Handheld UE for FR1 (NR SA and EN-DC)

7.2.1.1 Total Radiated Sensitivity (TRS) in Browsing Mode with Hand Phantom

7.2.1.1.1 Total Radiated Sensitivity (TRS) for FR1 NR Standalone (SA) in Browsing Mode with Hand Phantom

7.2.1.1.1.1 Test purpose

The purpose of this test is to ensure that $TRS_{average}$ of the UE, in browsing mode with hand phantom only, is above specified limit. The lack of the reception sensitivity decreases the coverage area at the far side from Node B.

7.2.1.1.1.2 Test applicability

This test case applies to all types of NR Power Class 2 and Power Class 3 UEs Release 17 and forward.

7.2.1.1.1.3 Minimum conformance requirements

The average measured total radiated sensitivity (TRS) of low, mid and high channel for handheld UE shall be lower than the average TRS requirement specified in subclauses 7.2.1.1 and 7.2.1.2. The averaging shall be done in linear scale for the TRS results of both right and left side of the phantom head in case of beside the head and hand phantom positions. For the hand phantom browsing mode position the averaging shall be done in linear scale for the TRS results of both right and left hand phantom measurements.

$$TRS_{average} = 10 \log \left[6 / \left(\frac{1}{10^{-\frac{P_{left_low}}{10}}} + \frac{1}{10^{-\frac{P_{left_mid}}{10}}} + \frac{1}{10^{-\frac{P_{left_high}}{10}}} + \frac{1}{10^{-\frac{P_{right_low}}{10}}} + \frac{1}{10^{-\frac{P_{right_mid}}{10}}} + \frac{1}{10^{-\frac{P_{right_high}}{10}}} \right) \right]$$

For UEs which do not support NR FR1 in stand-alone mode, EN-DC mode requirements apply. SA and EN-DC test case applicability is defined in Clause 4.3, and test case applicability based on power class capability is defined in Clause 4.4. The relevant test methodology is defined in Annexes A and B of the present document.

7.2.1.1.1.3.1 Hand phantom browsing mode

Hand phantom browsing mode positions are defined in Clause B.3.1.

7.2.1.1.1.3.2 Minimum conformance requirements for NR FR1 in hand phantom browsing position

Handheld UE TRS minimum performance requirement for NR FR1 bands in the hand phantom browsing position and the primary mechanical mode are defined in Tables 7.2.1.1.1.3.2-1.

Table 7.2.1.1.1.3.2-1: Handheld PC3 and PC2 UE TRS minimum performance requirement for NR FR1 bands in the hand phantom browsing position and the primary mechanical mode

NR Band	Bandwidth (MHz)	Usage Scenario	Power Class 3 and Power Class 2	
			Average TRS (dBm)	
			UE width ≤ 72mm	UE width > 72mm
n1	15	HL and HR		-88.5
n28	20	HL and HR		-83.5
n41	100	HL and HR		-80
n78	100	HL and HR		-81.2
n79	100	HL and HR		

The normative reference for this requirement is TS 38.161 [1] clause 7.2.1.1.1.

7.2.1.1.1.4 Test description

7.2.1.1.1.4.1 Initial conditions

Initial conditions are a set of test configurations that the UE needs to be tested in and the steps for the SS to take with the UE to reach the correct measurement state.

The initial test configurations consist of environmental conditions, test frequencies, test channel bandwidths and sub-carrier spacing based on NR operating bands specified in table 5.2.1-1. All these configurations shall be tested with applicable test parameters for each combination of test channel bandwidth and sub-carrier spacing and are shown in table 5.3-2. The details of the uplink and downlink test parameters mainly comprising the uplink modulation and uplink RB allocation are also specified in Table 5.3-2. Configurations of PDSCH and PDCCH before measurement are specified in Annex A.0

The following steps are recommended as per TR 38.834 [10]:

- P-MPR_c shall be 0 dB.
 - FR1 TRP radiated conformance testing shall be performed with the UE consistently operating at maximum power level, e.g., Time-Averaged Algorithm (TAA) and other power back-off functions should be disabled. The above functions being OFF should be based on manufacturer declaration; if declared, then the manufacturer is required to provide a mechanism for the test lab to enable/disable the function.
 - The NR SS should send continuous uplink power control “up” commands to the DUT to ensure the DUT’s transmitter is at maximum output power during the SA TRS test.
 - For TRS measurement, no specific setting is needed for Rx antennas. By default, the maximum number of Rx antennas supported at each band should be enabled during the TRS test.
1. Connect the SS to the UE antenna connectors as shown in TS 38.508-1 [2] Annex A, Figure A.3.1.1.1 for TE diagram and section A.3.2 for UE diagram.
 2. The parameter settings for the cell are set up according to TS 38.508-1 [2] subclause 4.4.3.
 3. Downlink signals are initially set up according to Annex C in TS 38.521-1 [11] and uplink signals according to Annex G in TS 38.521-1 [11].
 4. The UL and DL parameters are set according to Table 5.3-2.
 5. Propagation conditions are set to Static.
 6. Ensure the UE is in state RRC_CONNECTED with generic procedure parameters Connectivity NR, Connected without release On, Test Mode On and Test Loop Function On according to TS 38.508-1 [2] clause 4.5. Message contents are defined in clause 7.2.1.4.3.

7.2.1.1.1.4.2 Test procedure

For TRS measurement, the evaluations shall be performed at maximum transmit power. The measurement procedure includes the following steps:

1. Place the DUT inside the QZ following the UE positioning guidelines defined in Annex B.3.1.
2. SS transmits PDSCH via PDCCH DCI format 1_1 for C_RNTI to transmit the DL RMC according to Table 5.3-2. For any additional RMC parameters beyond Table 5.3-2 refer to Table 7.3.2.4.1-1 of TS 38.521-1 [11]. The SS sends downlink MAC padding bits on the DL RMC.
3. SS sends uplink scheduling information for each UL HARQ process via PDCCH DCI format 0_1 for C_RNTI to schedule the UL parameters defined in Table 5.3-2 and any additional parameters from Table 7.3.2.4.1-1. Since the UE has no payload data to send, the UE transmits uplink MAC padding bits on the UL RMC.
4. Ensure the DUT transmits with its maximum power by continuously sending uplink power control "up" commands in every uplink scheduling information to the UE; allow at least 200ms starting from the first TPC command in this step for the UE to reach PUMAX level.
5. The TRS of the DUT is measured by sampling effective isotropic sensitivity (EIS) of the DUT with three-dimensional scan at various locations surrounding the device. Determine each EIS by adjusting the downlink signal level until the minimum power level at which the throughput exceeds or equal to 95% of the maximum throughput of the specified RMC, at each sampling point. The downlink power step size shall be no more than 0.5 dB when the RF power level is near the NR sensitivity level.
6. The measurement is performed with a constant sampling step of in both theta (θ) and phi (ϕ) axes using any of the measurement grids and quadratures' options outlined and applicable to TRS in Table A.4.2.12-1. Any of the measurement grids in Table A.4.2.12-1 could be used for testing. Measurements at theta = 0 and 180 degrees only require one measurement each. For test systems that cannot measure 180° EIS, an extrapolation approach shall be adopted when generating the 3D antenna pattern and calculating TRS.
7. All of the measured power values at each position or measurement angle will be integrated to TRS, as defined in Annex A.3.5.2. with the procedure further detailed in Annex A.3.3.3
8. The reported TRS value shall be corrected by -0.5 output level step resolution of the final power step search and note the correction in the test report. If the alternate EIS search procedure is applied as described in A.3.3.3.1 to assess the EIS at each grid point, no correction of TRS shall be applied.

7.2.1.1.1.4.3 Message contents

Message contents are according to TS 38.508-1 [5] subclause 4.6 and 5.4 with the following exceptions.

Table 7.2.1.1.1.4.3-1: PUSCH-Config

Derivation Path: TS 38.508-1 [5], Table 4.6.3-118 with condition TRANSFORM_PRECODER_ENABLED

7.2.1.1.1.5 Test requirement

The TRS across low, mid and high channels tested with hand phantom browsing mode position shall be lower than test performance requirements shown in Table 7.2.1.1.1.5-1.

Table 7.2.1.1.1.5-1: Handheld PC3 and PC2 UE TRS minimum performance requirement for NR FR1 bands in the hand phantom browsing position and the primary mechanical mode

NR Band	Bandwidth (MHz)	Usage Scenario	Power Class 3 and Power Class 2	
			Average TRS (dBm)	
			UE width ≤ 72mm	UE width > 72mm
n1	15	HL and HR	FFS	-88.5+TT
n28	20	HL and HR	FFS	-83.5+TT
n41	100	HL and HR	FFS	-80+TT
n78	100	HL and HR	FFS	-81.2+TT
n79	100	HL and HR	FFS	FFS

Table 7.2.1.1.1.5-2: Test Tolerance (NR FR1 TRS)

Operating band	Test Tolerance (dB)
n1	1.28
n28	1.28
n41	1.28
n78	1.32

7.2.1.2 Total Radiated Sensitivity (TRS) in Talk Mode with Head and Hand Phantom

7.2.1.2.1 Total Radiated Sensitivity (TRS) for FR1 NR Standalone (SA) in Talk Mode with Head and Hand Phantom

Editor's note: This clause is incomplete:

- Test Applicability is pending

- Test Procedure, Message Contents and Test Requirements are pending.

- MU and TT are pending

7.2.1.2.1.1 Test purpose

To verify that the total radiated sensitivity (TRS) of a 5G NR FR1 UE in talk mode with head and hand phantom does not exceed the range prescribed by the specified nominal maximum output power and tolerance.

An excess maximum output power has the possibility to interfere to other channels or other systems. A small maximum output power decreases the coverage area.

7.2.1.2.1.2 Test applicability

FFS

7.2.1.2.1.3 Minimum conformance requirements

FFS

7.2.1.2.1.3.1 Head and Hand phantom browsing mode

Hand phantom browsing mode positions are defined in Clause B.3.1.

7.2.1.2.1.3.2 Minimum conformance requirements for NR FR1 in head and hand phantom talk mode position

Handheld UE TRP minimum performance requirement for NR FR1 bands in the beside head and hand phantom position and the primary mechanical mode are defined in Tables 7.2.1.2.1-1 and 7.2.1.2.1-2.

Table 7.2.1.2.1-1: Handheld PC3 and PC2 UE TRS minimum performance requirement for NR FR1 bands in the beside head and hand phantom position and the primary mechanical mode

NR Band	Bandwidth (MHz)	Usage Scenario	Power Class 3 and Power Class 2	
			Average TRS (dBm)	
			UE width ≤ 72mm	UE width > 72mm
n1	15	BHHL and BHHR		-87
n28	20	BHHL and BHHR		-80
n41	100	BHHL and BHHR		-79
n78	100	BHHL and BHHR		-80
n79	100	BHHL and BHHR		

7.2.1.2.1.4 Test description

FFS

7.2.1.2.1.4.2 Test procedure

FFS

7.2.1.2.1.4.3 Message contents

FFS

7.2.1.2.1.5 Test requirement

FFS

Annex A (normative): Test methodology

A.1 General

TRP TRS minimum requirement specified in Clause 6 and Clause 7 should be measured with Anechoic Chamber method.

A.2 UE configuration

A.2.1 General

For FR1 TRP and TRS radiated conformance testing, P-MPRc shall be 0 dB.

FR1 TRP and TRS radiated conformance testing shall be performed with the UE consistently operating at maximum power level, e.g., Time-Averaged Algorithm (TAA) and other power back-off functions should be disabled. The above functions OFF should be based on manufacturer declaration, if declared, then the manufacturer is required to provide a mechanism for the test lab to enable/disable the function.

The NR SS should send continuous uplink power control “up” commands to the DUT to ensure the DUT’s transmitter is at maximum output power during the TRP and TRS test.

A.2.2 UE configuration for TRP test

For devices containing multiple Tx antennas, the Tx Antenna Switching (TAS) function should be OFF, and the TRP should be measured for each Tx antenna individually. The antenna with better TRP is identified as the primary antenna, and the corresponding TRP result will be used to determine the pass/fail compliance. Otherwise, the primary antenna should be selected based on manufacturer declaration. To ensure the TAS OFF testing, the manufacture should provide either software/guidance to lab to control which Tx antenna is used, or the pre-configured DUT locked at primary antenna.

For Standalone, the NR System Simulator (SS) and DUT shall be configured per TS 38.521-1 [11], clause 6.2.1 (UE maximum output power) using the default settings specified in TS 38.521-1 [11] and TS 38.508-1 [2] as applicable. The measurement should be carried out based on the detailed test parameters for each band, as defined in TR 38.834 Table 4.3.3-1.

For EN-DC, the SS and DUT shall be configured per TS 38.521-3 [14], clause 6.2B.1 (UE Maximum Output Power for EN-DC) using the default settings specified in TS 38.521-3 [14] and TS 38.508-1 [2] as applicable. The measurement should be carried out based on the detailed test parameters for each band, as defined in TR 38.834 [10] Table 4.3.3-3. The UL output power of LTE carrier should be set as a constant power of 10dBm, while measuring NR at maximum output power, i.e., with fixed p-MaxEUTRA-r15=10 dBm, and p-NR-FR1 not configured.

A.2.3 UE configuration for TRS test

For TRS measurement, no specific setting is needed for Rx antennas. By default, the maximum number of Rx antennas supported at each band should be enabled during the TRS test.

For Standalone, the NR System Simulator (SS) and DUT shall be configured per clause 7.3.2 (Reference sensitivity power level) of TS 38.521-1 [11] using the defaults specified in TS 38.521-1 [11] and TS 38.508-1 [2] as applicable. The measurement should be carried out based on the detailed test parameters for each band, as defined in TR 38.834 [10] Table 4.3.3-2.

For EN-DC, the EN-DC SS and DUT shall be configured per clause 7.3B.2 (Reference Sensitivity for EN-DC) of TS 38.521-3 [14], using the defaults specified in TS 38.521-3 [14] and TS 38.508 [2], as applicable. The measurement should be carried out based on the detailed test parameters for each band, as defined in TR 38.834 Table 4.3.3-3. The UL power configuration for LTE and NR is 50%-50% power splitting, i.e.,

- For PC3, p-MaxEUTRA-r15=20 dBm, and p-NR-FR1= 20dBm;
- For PC2, p-MaxEUTRA-r15=23 dBm, and p-NR-FR1= 23dBm.

A.3 Test system of Anechoic Chamber method

A.3.1 System setup

For FR1 TRP TRS testing, both Single-antenna and multiple-antennas anechoic chambers can both be applied. In Figure A.3.1-1, an example TRP TRS test system with combined axes system is presented.

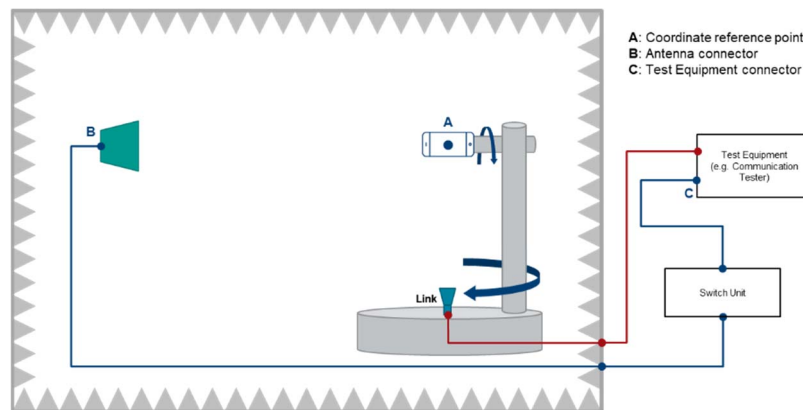

Figure A.3.1-1: Example of a FR1 TRP TRS OTA test system with combined axis

In Figure A.3.1-2, an example TRP TRS test system with distributed axes system is presented.

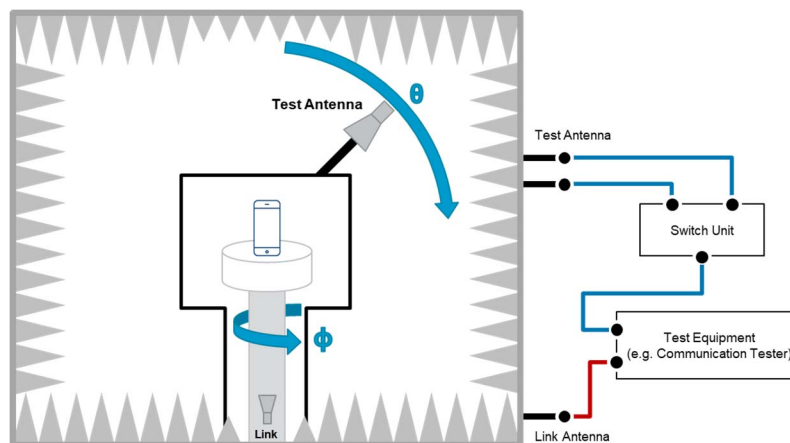

Figure A.3.1-2: Example of a FR1 TRP TRS OTA test system with distributed axis

A.3.2 Calibration procedure

The relative power values of the measurement points will be transformed to absolute radiated power values (in dBm) by performing a range path loss calibration measurement. The system needs to be calibrated by using a reference calibration antenna with known gain values. In the range path loss calibration measurement, the reference antenna is measured in the same place as the DUT, i.e. the centre of the QZ, and the attenuation of the complete transmission path (L_{total}) from the DUT to the measurement receiver/BS simulator is calibrated out.

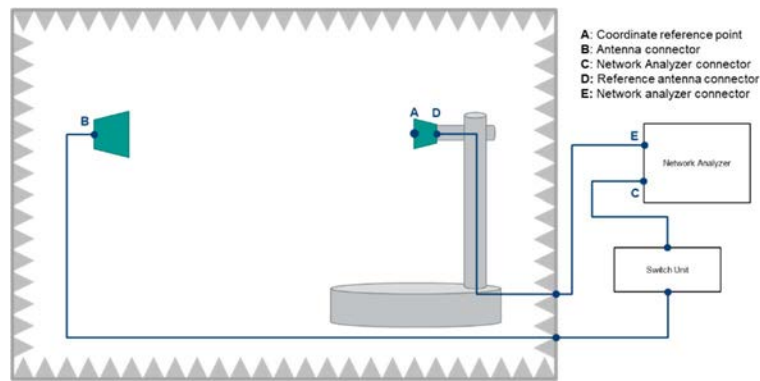

Figure A.3.2-1: Example FR1 TRP TRS calibration setup

The calibration measurement is repeated for each measurement path (two orthogonal polarizations and each signal path). The range path loss calibration measurement is performed in a two-step process including total path loss measurement and cable calibration.

Step 1: Cable calibration: the measurement of path loss L_{DE} , by connecting the cable from D to E to the two ports of VNA, and measure the cable path loss.

Step 2: Total path loss measurement: the measurement of total path loss L_{BC} :

1. Place the reference calibration antenna (e.g. reference dipole) in the centre of the test zone aligned with θ polarization of the measurement antenna, connected to a VNA port E, with the other VNA port C connected to the input of the Switch box – in Figure A.3.2-1.
2. Configure the proper output power of VNA.
3. Measure the response LCE of each path from each θ polarization of the measurement antenna to the reference antenna in the centre of QZ.
4. Repeat the steps 1 to 3 with the reference antenna aligned with the ϕ polarization of the measurement antenna.

Then, the $L_{total} = (L_{CE} - L_{DE} + G_{cal})$, Where L_{DE} is cable loss from D to E. G_{cal} is the gain or efficiency of the calibration antenna at the frequency of interest. In TRP and TRS measurements point C is connected to the calibrated input/output port of measurement receiver.

This range path loss calibration procedure is common to both SA and EN-DC measurements.

This procedure shall be repeated on a regular basis, i.e., at least one per year, and any time the conducted and/or radiated signal paths have been affected, e.g., change in propagation conditions, replacement of cables, change in measurement antennas/probes, etc. It is recommended to perform this procedure rather frequently, e.g., monthly, to assess system stability.

A.3.3 Test procedure

A.3.3.1 General

For TRP and TRS testing in SA or EN-DC mode, measurements should be only performed at NR carrier. The LTE link antenna in EN-DC mode is used to provide a stable LTE link to the DUT without precise path loss or polarization control.

A.3.3.2 TRP Test procedure

The TRP of the DUT is measured by sampling the radiated transmit power of the DUT with three-dimensional scan at various locations surrounding the device. The measurement is performed with a constant sampling step in both theta (θ) and phi (ϕ) axes using any of the measurement grids and quadratures options outlined and applicable to TRP in Table A.4.2.12-1. Measurements at theta = 0 and 180 degrees only require one measurement each. For some test system

cannot measure 180° EIRP, an extrapolation approach shall be adopted when generating the 3D antenna pattern and calculating TRP. All of the measured power values will be integrated to TRP, as defined in Clause 5.1 in TR 38.834 [10].

For TRP measurement, the evaluations shall be performed at maximum transmit power.

The measurement procedure includes the following steps:

1. Place the DUT inside the QZ following the positioning guideline defined in Clause 6 of TR 38.834 [10].
2. Connect the SS with the DUT through the link antenna following steps 1 and 2 in section 6.2.1.4.2 of TS 38.521-1 [11] and ensure the DUT transmits with its maximum power.
3. Measure the power at each measurement point, and calculate $EIRP(\theta, \phi)$ by adding the composite loss of the entire transmission path.

The TRP value is calculated using the TRP integration approaches outlined in Clause 5.1 in TR 38.834 [10].

This TRP test procedure is common to both SA and EN-DC measurements. The detailed UE configurations for TRP test in SA and EN-DC mode are specified in Clause A.2.

A.3.3.3 TRS Test procedure

The TRS of the DUT is measured by sampling effective isotropic sensitivity (EIS) of the DUT with three-dimensional scan at various locations surrounding the device. The measurement is performed with a constant sampling step in both theta (θ) and phi (ϕ) axes using any of the measurement grids and quadratures options outlined and applicable to TRS in Table A.4.2.12-1.

EIS, or receiver sensitivity measurements, is defined as the minimum downlink signal power received at the UE antenna input required to provide a data throughput rate greater than or equal to 95% of the maximum throughput of the reference measurement channel (RMC) (the maximum throughput is per Appendix A of TS 38.521-1 [11]).

For TRS measurement, the evaluations shall be performed at maximum transmit power.

The measurement procedure includes the following steps:

1. Place the DUT inside the QZ following the positioning guideline defined in Clause 6.
2. Connect the SS with the DUT through the measurement antenna.
3. Follow steps 1 through 4 in section 7.3.2.4.2 of TS 38.521-1 [11], with the following exception: determine each EIS, i.e., by adjusting the downlink signal level until the minimum power level at which the throughput exceeds or equal to 95% of the maximum throughput of the specified RMC, at each sampling point. The downlink power step size shall be no more than 0.5 dB when the RF power level is near the NR sensitivity level.

The TRS value is calculated using the equation outlined in Clause A.3.5.2. The reported TRS value shall be corrected by $-0.5 \cdot \text{output level step resolution}$ of the final power step search and note the correction in the test report. If an alternate EIS search procedure, detailed in A.3.3.3.1, is applied to assess the EIS at each grid point, no correction of TRS shall be applied.

This TRS test procedure is common to both SA and EN-DC measurements. The detailed UE configurations for TRS test in SA and EN-DC mode are specified in Clause A.2.

A.3.3.3.1 Alternate EIS Search Procedure

The following alternate EIS search procedure methods can be used given that the corresponding uncertainty term as described in A.4.2.6 is considered.

A.3.3.3.1.1 EIS linearization using polynomial interpolation

An approach to approximate the sensitivity threshold is to empirically determine the polynomial interpolation based on the DUT sensitivity response, which is characterized with a fine step size using following this procedure for each channel:

1. At the first grid point, or at any arbitrary reference initial position, an EIS search is performed with a very fine power step size (e.g. 0.1dB) capturing the DL power vs. Throughput for a sufficient DL power range (e.g. 1dB) around the sensitivity threshold.
2. Based on the results in step 1, curve fitting techniques are used to obtain the best fit n degree polynomial characterizing the DUT sensitivity response
3. The EIS measurement per grid point is performed as described in clause 7.2.1.1.4.2 using the maximum power step size allowed (i.e. 0.5dB), but the final EIS value per grid point is interpolated using the polynomial coefficients calculated in step 2.
4. All of the resulting EIS values per grid point, calculated as described in step 3, are integrated to TRS as defined in Annex A.4.5.2.

The polynomial coefficients calculated in step 2 shall be reported together with the TRS result.

The default and alternate approaches are visualized in Figure A.3.3.3.1.1-1 for a set of throughput measurement results with a downlink power step size of 0.5 dB near the sensitivity level. For the classical approach, the last passing downlink power level/EIS is recorded (X plotted with green dot). For the optional EIS linearization using polynomial interpolation approach, a polynomial curve, determined earlier, is applied to the last passing (green) and failing (red) DL power levels and the interpolated EIS at the 95% maximum throughput (blue star) is recorded.

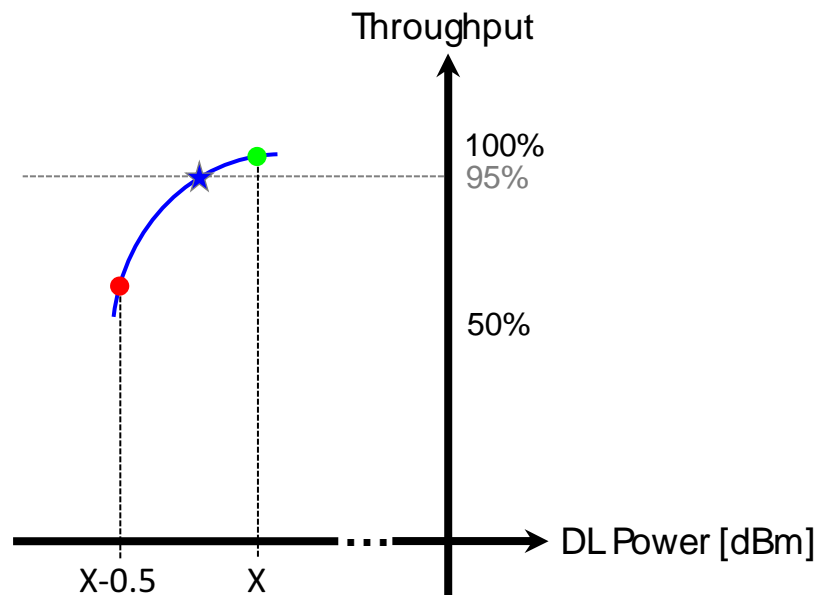

Figure A.3.3.3.1.1-1: Discrete TP measurements and EIS linearization using polynomial interpolation

A.3.4 Minimum Range Length

This sub-section specifies the minimum range lengths for Anechoic-Chamber-based FR1 TRP-TRS OTA systems. The range length is defined as the distance from the centre of the quiet zone to the aperture of the measurement probes/antennas, as illustrated in Figure A.3.4-1.

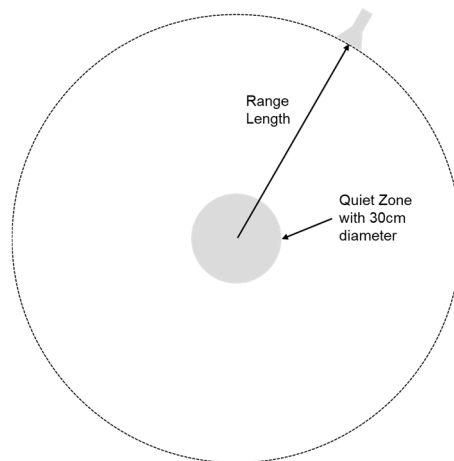

Figure A.3.4-1: Illustration of range length definition

The minimum range length shall be the maximum of the following three limits

- The phase uncertainty limit: $R_{QZ} + 2D_{\text{rad}}^2/\lambda$
- The amplitude uncertainty limit: $3D$
- The reactive Near-Field limit: $R_{QZ} + 2\lambda$

where R_{QZ} is defined as the radius of the quiet zone, i.e., $R_{QZ} = D/2$, and D_{rad} is the diameter of the effective radiating aperture. The minimum range length calculations for $D=30\text{cm}$ quiet zone size TRP-TRS OTA test systems shall assume that D_{rad} is 30cm below 1GHz and decrease linearly from 30cm to 5cm from 1GHz to 7.125GHz, respectively. The last column of Table A.3.4-1 shall be considered the minimum range length for NR FR1 TRP-TRS OTA systems with 30cm quiet zone size.

Table A.3.4-1: Minimum Range Length for NR FR1 TRP-TRS OTA systems with 30cm quiet zone size

F [GHz]	D _{rad} [m]	R _{Qz} +2D _{rad} ² /λ	3D = 6R _{Qz}	R _{Qz} +2λ	max(R _{Qz} +2λ, 3D, R _{Qz} +2D ² /λ)
0.41	0.30	0.40	0.9	1.61	1.61
0.6	0.30	0.51	0.9	1.15	1.15
0.7	0.30	0.57	0.9	1.01	1.01
0.8	0.30	0.63	0.9	0.90	0.90
1	0.30	0.75	0.9	0.75	0.90
1.2	0.29	0.83	0.9	0.65	0.90
1.4	0.28	0.90	0.9	0.58	0.90
1.6	0.28	0.96	0.9	0.52	0.96
1.8	0.27	1.01	0.9	0.48	1.01
2	0.26	1.05	0.9	0.45	1.05
2.2	0.25	1.07	0.9	0.42	1.07
2.4	0.24	1.09	0.9	0.40	1.09
2.6	0.23	1.11	0.9	0.38	1.11
2.8	0.23	1.11	0.9	0.36	1.11
3	0.22	1.10	0.9	0.35	1.10
4	0.18	0.99	0.9	0.30	0.99
5	0.14	0.77	0.9	0.27	0.90
6	0.10	0.52	0.9	0.25	0.90
7	0.06	0.29	0.9	0.24	0.90
7.125	0.05	0.27	0.9	0.23	0.90

A.3.5 Definition of TRP and TRS for AC

A.3.5.1 Total Radiated Power (TRP)

This definition is used to calculate the Total Radiated Power (TRP) value. For Anechoic Chamber method, TRP is defined as:

$$TRP = \frac{1}{4\pi} \int_{\theta=0}^{\pi} \int_{\phi=0}^{2\pi} [EIRP_{\theta}(\theta, \phi) + EIRP_{\phi}(\theta, \phi)] \sin(\theta) d\phi d\theta$$

Where the effective isotropic radiated power (EIRP) is defined as

$$EIRP(\theta, \phi) = P_T G_T(\theta, \phi)$$

Where $P_T G_T$ is the product of the power delivered to the antenna and the antenna's power gain, and $EIRP_{\theta}$ and $EIRP_{\phi}$ are the EIRP in the corresponding θ and ϕ polarizations.

The summation form based on the $\sin\theta \cdot \Delta\theta$ weights of TRP with Anechoic Chamber method is defined as:

$$TRP \approx \frac{\pi}{2NM} \sum_{n=0}^{N-1} \sum_{m=0}^{M-1} [EIRP_{\theta}(\theta_n, \phi_m) + EIRP_{\phi}(\theta_n, \phi_m)] \sin \theta_n$$

Where N and M are the number of sampling intervals for θ and ϕ . θ_n and ϕ_m are the measurement angles.

The summation form based on the Clenshaw-Curtis quadrature integral approximation of TRP with Anechoic Chamber method is defined as:

$$TRP \approx \frac{1}{2M} \sum_{n=0}^N \sum_{m=0}^{M-1} [EIRP_{\theta}(\theta_n, \phi_m) + EIRP_{\phi}(\theta_n, \phi_m)] W(\theta_n)$$

where the value of $W(\theta_n)$ can be calculated as follows:

$$W(\theta_n) = \frac{c_n}{N} \left[1 - \sum_{j=1}^{\text{int}(\frac{N}{2})} \frac{b_j}{4j^2-1} \cos(2j\theta_n) \right]$$

with

$$b_j = \begin{cases} 1, & 2j = N \\ 2, & \text{otherwise} \end{cases}$$

and

$$c_n = \begin{cases} 1, & n = 0 \text{ or } N \\ 2, & \text{otherwise} \end{cases}$$

A.3.5.2 Total Radiated Sensitivity (TRS)

This definition is used to calculate the Total Radiated Sensitivity (TRS) value. For Anechoic Chamber method, the TRS is defined as:

$$TRS = \frac{4\pi}{\int_{\theta=0}^{\pi} \int_{\phi=0}^{2\pi} \left[\frac{1}{EIS_{\theta}(\theta, \phi)} + \frac{1}{EIS_{\phi}(\theta, \phi)} \right] \sin \theta \, d\phi \, d\theta}$$

Where the effective isotropic sensitivity (EIS) is defined as the minimum power level at which the throughput exceeds or equal to 95% of the maximum throughput of the specified RMC, at each sampling point, and EIS_{θ} and EIS_{ϕ} are the EIS in the corresponding θ and ϕ polarizations.

The summation form based on the $\sin\theta \cdot \Delta\theta$ weights of TRS with Anechoic Chamber method defined as:

$$TRS \approx \frac{2NM}{\pi \sum_{n=0}^{N-1} \sum_{m=0}^{M-1} \left[\frac{1}{EIS_{\theta}(\theta_n, \phi_m)} + \frac{1}{EIS_{\phi}(\theta_n, \phi_m)} \right]} \sin \theta_n$$

Where N and M are the number of sampling intervals for θ and ϕ . θ_n and ϕ_m are the measurement angles.

The summation form based on the Clenshaw-Curtis quadrature integral approximation of TRS with Anechoic Chamber method is defined as:

$$TRS \approx \frac{2M}{\sum_{n=0}^N \sum_{m=0}^{M-1} \left[\frac{1}{EIS_{\theta}(\theta_n, \phi_m)} + \frac{1}{EIS_{\phi}(\theta_n, \phi_m)} \right]} W(\theta_n)$$

where the value of $W(\theta_n)$ can be calculated as follows (same equation as TRP):

$$W(\theta_n) = \frac{c_n}{N} \left[1 - \sum_{j=1}^{\text{int}(\frac{N}{2})} \frac{b_j}{4j^2-1} \cos(2j\theta_n) \right]$$

with

$$b_j = \begin{cases} 1, & 2j = N \\ 2, & \text{otherwise} \end{cases}$$

and

$$c_n = \begin{cases} 1, & n = 0 \text{ or } N \\ 2, & \text{otherwise} \end{cases}$$

A.3.6 TAS OFF verification procedure (Informative)

As described in Clause 8.2.2 and 9.2.2, for SA and EN-DC testing respectively, the TAS OFF should be ensured before performing TRP test. In order to provide guidance on how to check UE antenna locking condition, this clause provides an informative test procedure to verify TAS OFF.

The general verification procedure is as following:

- Perform OTA TRP measurement baseline test with top of device pointing towards +Z and display oriented at phi (azimuth) 0 degree following the traditional alignment method;
- Benchmark with similar TRP measurement OTA test with top of device pointing towards -Z and display oriented at phi (azimuth) 0 degree. The point equivalently spaced from the bottom of the device as the original reference point is spaced from the top of the device will be positioned at the centre of the quiet zone.

Expectation: The magnitude of the TRP measurement being equal; similar 2D and/or 3D radiation pattern is expected (with 180 degrees rotation). This provides non-intrusive confirmation that the device indeed is tested with TAS OFF.

An additional alignment option to perform the above verification procedure is to orient the display in vertical alignment (along z-axis) flip the DUT upside down (vary theta) and perform the comparison of radiation pattern as described above.

The applicability of this verification procedure is pending. The criteria of confirming TAS-OFF based on above verification procedure is pending.

NOTE: The above test procedure is informative and not a mandated action for test lab to be done before UE TRP testing.

A.3.7 Ripple test for Quiet Zone

A.3.7.1 General

The ripple test procedure is defined in this clause. Frequencies to be used for ripple test:

Table A.3.7.1-1: Frequencies for FR1 ripple test

NR FR1 Bands	Range	Test frequency (MHz)
n71	Low	617MHz
n12, n17, n29, n14, n28		722MHz
n5, n8, n18, n20		836.5MHz
n50, n51, n74	Mid	1575.42MHz
n3, n2, n25, n39		1880MHz
n1, n34, n65		2132.5MHz
n7, n30, n41, n40, n38, n90		2450MHz
n77, n78	High	3600MHz
n79		[4700MHz]

A.3.7.2 Ripple test procedure

Unwanted reflections and support structure blockage cause a volumetric ripple to the field magnitude measured by or created by the measurement antenna as shown in Figure A.3.7.2-1, affecting every possible test point within a desired test volume. By rotating an omnidirectional antenna through the test volume as illustrated by the red line, this volumetric ripple may be probed to obtain an estimate of the measurement uncertainty due to this volumetric error. Note, however, that the volumetric ripple caused by multipath reflections is related to the wavelength and the relative path lengths of the direct and reflected paths to the measurement antenna and is not inherently a function of the test volume. As illustrated in Figure A.3.7.2-1(left), when the wavelength is relatively large compared to the test volume, it may not be possible to probe the entire range of errors that may actually exist within the test volume. Doing so would require probing an area larger than the test volume in order to accurately estimate the error within the test volume. Even when the test volume is several wavelengths in size, a given evaluation of the ripple may not completely caliper the worst-case error conditions within the test volume (Figure A.3.7.2-1 (right)).

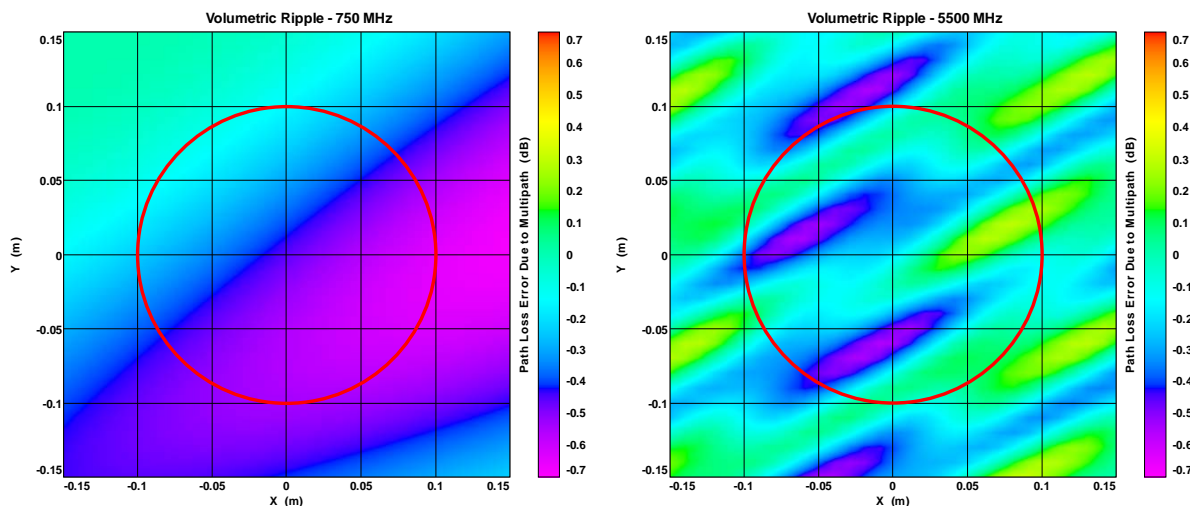

Figure A.3.7.2-1: Volumetric ripple and 20cm Phi axis cut

Conversely, field non-uniformities in the test volume caused by amplitude taper of the measurement antenna and shadowing of portions of the test volume by support structure are geometric in nature and relate directly to the size of the test volume and the related factors of the measurement antenna and support structure. This test procedure attempts to capture the impact of these effects to within the practical limits of the available test volume and test equipment expected in the lab.

The quiet zone ripple test covers two cylindrical test volumes, one for handsets and smaller devices, with or without head and/or hand phantoms, and a larger volume for testing up to notebook PC sized devices. The smaller cylinder is 30 cm in diameter, concentric to the phi axis, and 30 cm tall along the phi axis, centred on the intersection of the theta and phi axes. The larger cylinder is 50 cm in diameter, concentric to the phi axis, with the base of the cylinder coincident with that of the smaller cylinder and a height of 36 cm along the phi axis. The test consists of a set of individual ripple tests about the phi- and theta-axes utilizing both electric dipoles and magnetic loop dipoles to generate uniform omnidirectional dipole-like patterns about the axis of rotation. Data is measured on the co-polarized measurement antenna element for each corresponding test.

For the phi-axis ripple test, each reference antenna is oriented with its axis parallel to the phi axis at a total of three positions, offset 15 cm perpendicular to the phi axis with 0 cm and ± 15 cm offsets parallel to the phi axis. At each position, the phi axis is rotated 360° to record the ripple. Each position is labelled by its radial and axial offset from the centre position, (R, Z). See Figure A.3.7.2-2 for additional information.

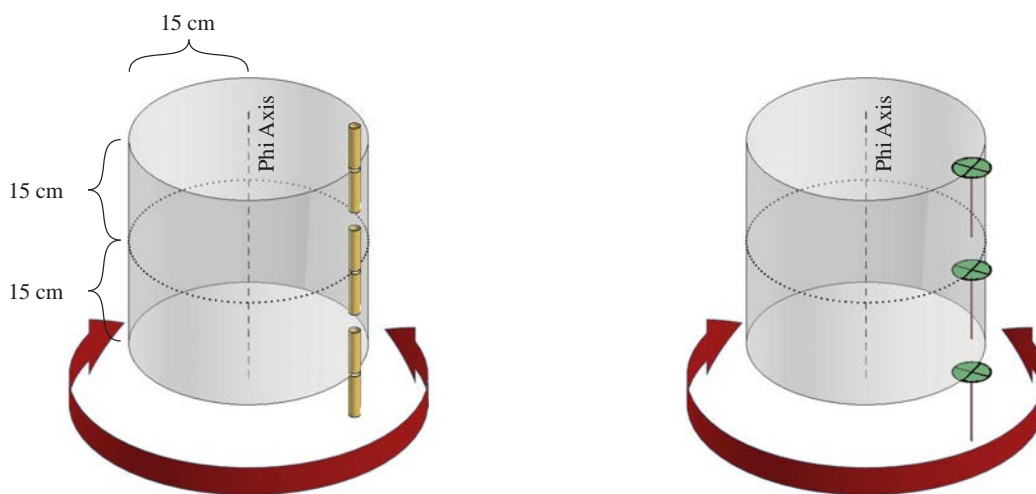

Figure A.3.7.2-2: Phi-axis test geometry

For the notebook sized test volume, three additional test positions are added to the phi-axis test in order to cover the larger test cylinder. These positions are offset 25 cm perpendicular to the phi axis with -15, 0, and +21 cm offsets parallel to the phi axis, as shown in Figure A.3.7.2-3.

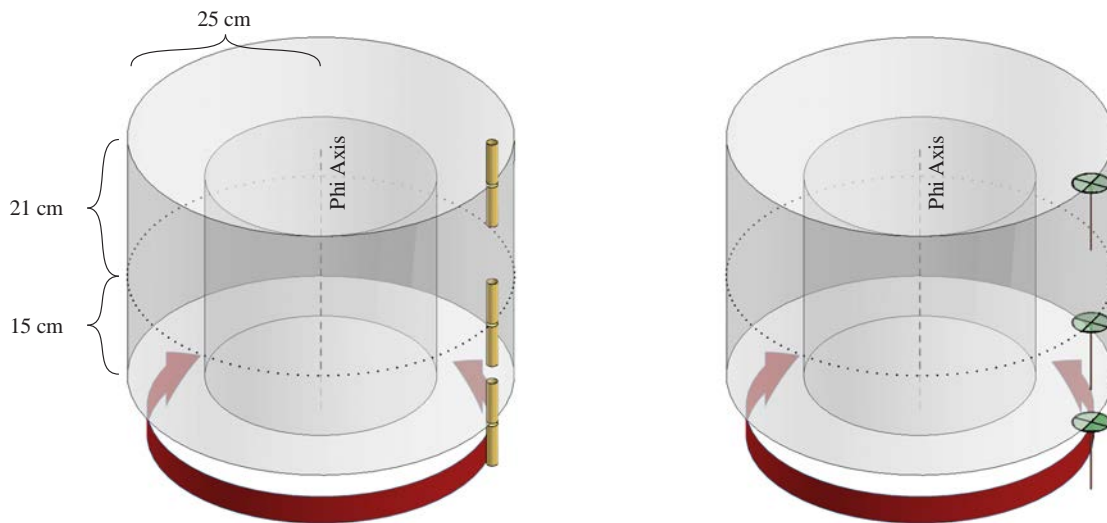

Figure A.3.7.2-3: Phi-axis test geometry for the notebook sized test volume

For the theta-axis ripple test, each reference antenna is oriented with its axis parallel to the theta axis at a total of eight positions on the surface of the cylinder defined above. Defining Cartesian coordinates (X, Y, Z) with the Z-axis along the phi-axis, the Y-axis along the theta-axis, and the measurement antenna moving in the XZ plane relative to the reference antenna used for the ripple test, the test positions are given as $(\pm 15 \text{ cm}, 0, \pm 15 \text{ cm})$ and $(0, \pm 15 \text{ cm}, \pm 15 \text{ cm})$, relative to the centre of the test volume as shown in Figure A.3.7.2-4. At each position, the theta axis is rotated over as much of 360° as supported by the system to record the ripple (e.g. $\pm 165^\circ$). For systems that can only move theta in the range of $0-180^\circ$ or less, the phi axis may be rotated 180° and a second cut measured to meet or exceed the $\pm 165^\circ$ range. Each position is labelled by its (X, Y, Z) offset from the centre position.

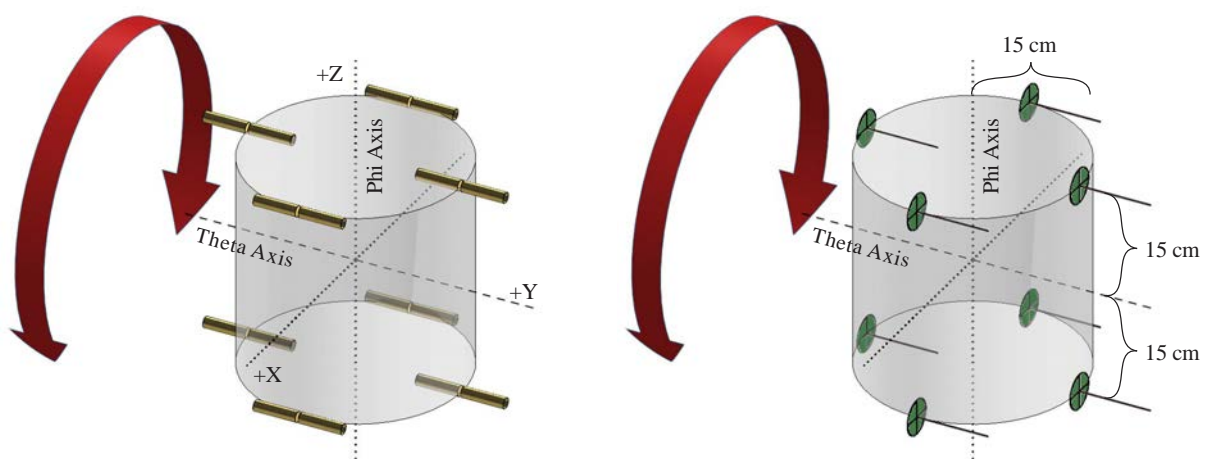

Figure A.3.7.2-4: Theta-axis test geometry

For the notebook sized test volume, eight additional test positions are added to the theta-axis test in order to cover the larger test cylinder. These positions are given as $(\pm 25 \text{ cm}, 0, -15 \text{ cm})$, $(\pm 25 \text{ cm}, 0, +21 \text{ cm})$, $(0, \pm 25 \text{ cm}, -15 \text{ cm})$, and $(0, \pm 25 \text{ cm}, +21 \text{ cm})$, as shown in Figure A.3.7.2-5.

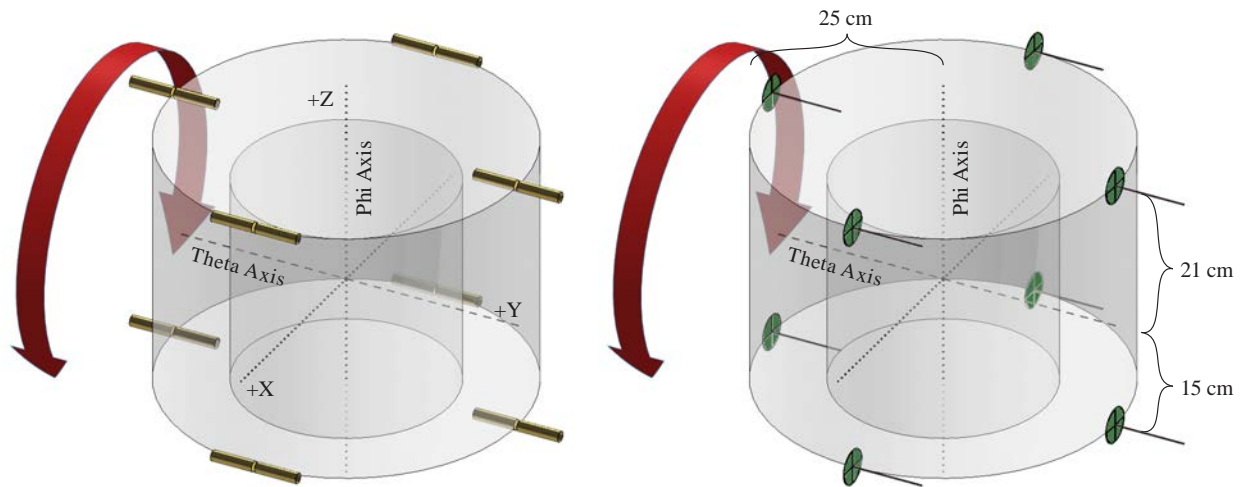

Figure A.3.7.2-5: Theta-axis test geometry for the notebook sized test volume

For each polarization and band, repeat the following steps:

For the phi-axis ripple test:

1. Place the measurement antenna and any associated theta-axis positioner at $\theta = 90^\circ$ such that the measurement antenna is boresight with the centre of the quiet zone. The measurement antenna should be at the same separation distance to be used for actual pattern measurements. This distance must be at least the minimum measurement distance away from the centre of the quiet zone as defined in clause A.3.4. Select the polarization of the measurement antenna to correspond to the polarization (theta or phi) to be tested.
2. Mount the reference antenna to the phi-axis positioner using a low permittivity dielectric support. Use the sleeve dipole for the theta polarization and the loop for the phi polarization. At each of the specified offset positions, ensure that the axis of the reference antenna is parallel to the phi axis of rotation.
3. Attach a signal source to a coaxial cable feeding the measurement antenna and set the frequency to the appropriate channel. Set the amplitude to a level appropriate for the measurement receiver. Connect a measurement receiver to the reference antenna. The received signal during the ripple test measurement should be at least 40 dB above the noise floor or noise errors greater than 0.1 dB will result. Ensure that all coaxial cables are dressed to minimize effects upon the measurement results.
4. Rotate the reference antenna about the phi axis and record the signal received by the measurement antenna at resolution sufficient to ensure smoothly varying curves for a total of 360° .
5. Record the measurement results in a format suitable for calculating the ripple test metric.
6. Record test parameters including: (a) the distance between the measurement and reference antennas, (b) cable losses and other losses associated with the measurement setup, (c) the power of the signal source at the reference antenna connector, and (d) the noise level of the receiver with no signal applied.
7. Repeat steps 1 through 6 above for each reference antenna (polarization and band) for each of the required test positions. In order to accommodate reference positioning in the lower portion of the quiet zone, support materials with a dielectric constant less than 1.2 may be removed to a maximum distance of 25 cm outside the quiet zone for the tests that require additional clearance.

For the theta-axis ripple test:

1. Place the measurement antenna such that it is boresight with the centre of the quiet zone. The measurement antenna should be at the same separation distance to be used for actual pattern measurements. This distance must be at least the minimum measurement distance away from the centre of the quiet zone as

defined in clause A.3.4. Select the polarization of the measurement antenna to correspond to the polarization (theta or phi) to be tested.

2. Mount the reference antenna in the quiet zone using a low permittivity dielectric support and such that rotating the theta positioner will cause the measurement antenna to rotate relative to the reference antenna. Use the sleeve dipole for the phi polarization and the loop for the theta polarization. At each of the specified offset positions, ensure that the axis of the reference antenna is parallel to the theta axis of rotation.
3. Attach a signal source to a coaxial cable feeding the measurement antenna and set the frequency to the appropriate channel. Set the amplitude to a level appropriate for the measurement receiver. Connect a measurement receiver to the reference antenna. The received signal during the ripple test measurement should be at least 40 dB above the noise floor or noise errors greater than 0.1 dB will result. Ensure that all coaxial cables are dressed to minimize effects upon the measurement results.
4. Rotate the reference antenna about the theta axis and record the signal received by the measurement antenna at resolution sufficient to ensure smoothly varying curves for a total of at least $\pm 165^\circ$ or the equivalent (e.g. 0-360°). For systems that are unable to rotate a full $\pm 165^\circ$, the reference antenna may be mounted to the phi axis and two separate theta cuts from 0 to 165° may be taken, after rotating the phi axis 180° between the first and second cut.
5. Record the measurement results in a format suitable for calculating the ripple test metric.
6. Record test parameters including: (a) the distance between the measurement and reference antennas, (b) cable losses and other losses associated with the measurement setup, (c) the power of the signal source at the reference antenna connector, and (d) the noise level of the receiver with no signal applied.
7. Repeat steps 1 through 6 above for each reference antenna (polarization and band) for each of the required test positions. In order to accommodate reference positioning in the lower portion of the quiet zone, support materials with a dielectric constant less than 1.2 may be removed to a maximum distance of 25 cm outside the quiet zone for the tests that require additional clearance.

The ripple test shall be repeated when the RF/propagation conditions inside the chamber have changed, e.g., the chamber has been disassembled and reassembled, portions of the absorber been replaced, measurement antennas/probes been replaced, positioning system been replaced, etc.

A.4 (Informative): Estimation of measurement uncertainty

A.4.1 General

Individual uncertainty contributions in the TRP and TRS measurements are discussed and evaluated in this Annex. A technique for calculating the total measurement uncertainty is also presented.

An important part of a standard measurement procedure is the identification of uncertainty sources and the evaluation of the overall measurement uncertainty. There are various individual uncertainty sources in the measurement procedure that introduce a certain uncertainty contribution to the final measurement result. The approach in this standard test procedure is that the test laboratories are not limited to using some specific instruments and antenna positioners, for example.

The TRP/TRS measurement procedure can be considered to include two stages. In Stage 1 the calibration of the absolute level of the DUT measurement results is performed by means of using a calibration antenna whose absolute gain/radiation efficiency is known at the frequencies of interest. In Stage 2 the actual measurement of the 3-D pattern of the Device Under Test (DUT) is performed. The uncertainty contributions are analysed in clause A.4.2 while the uncertainty budget and example tables related to TRP and TRS are listed in clauses A.4.3 and A.4.4 respectively.

The calculation of the uncertainty contribution is based on the Guide to the expression of uncertainty in measurement [4]. Each individual uncertainty is expressed by its Standard Deviation (termed here as 'standard uncertainty') and represented by symbol U. The uncertainty contributions can be classified to two categories: Type-A uncertainties, which are statistically determined e.g. by repeated measurements, and Type-B uncertainties, which are derived from existing data e.g. data sheets. Several individual uncertainties are common in Stage 1 and Stage 2 and therefore cancel.

The procedure of forming the uncertainty budget is:

1. Compile lists of individual uncertainty contributions for TRP or TRS measurement in both Stage 1 and Stage 2.
2. Determine the standard uncertainty of each contribution by
 - a. Determining the distribution of the uncertainty (Actual, U-shaped, rectangular, normal, etc.)
 - b. Determining the maximum value of each uncertainty (unless the distribution is Actual)
 - c. Calculating the standard uncertainty by dividing the uncertainty by $\sqrt{2}$ if the distribution is U-shaped, by $\sqrt{3}$ if the distribution is rectangular, and by 2 if the distribution is normal.
3. Convert the units (if necessary) of each uncertainty element into the chosen unit, i.e. dB.
4. Combine all the standard uncertainties by the root-sum-squares (RSS) method to derive the ‘combined standard uncertainty’.
5. Multiply the result by an expansion factor of 1.96 to derive expanded uncertainty at 95% confidence level: $1.96 \cdot U_c$.
6. Systematic errors, commonly either DUT or test system dependent, captured in the MU budget are added to the expanded uncertainty to derive the ‘total expanded uncertainty’, i.e.,

$$u_{c,\text{total expanded}} = u_{c,\text{expanded}} + u_{c,\text{systematic}} = 1.96 \sqrt{\sum u_i^2} + \sum u_{i,\text{systematic}}$$

NOTE 1: The standard deviation from a data set of N samples is defined as

$$u_i = \sqrt{\frac{1}{N-1} \sum_{k=1}^N |s_k - \bar{s}|^2}$$

where s_k are the respective sample results and \bar{s} the mean of all N samples. For an uncertainty u_i in dB, the dB values (instead of the linear powers) of s_k and \bar{s} are used.

The combination of uncertainties is performed using dB values for simplicity. It has been shown that using dB uncertainty values gives a slightly worse combined uncertainty result than using linear values for the uncertainties. The analysis method therefore errs on the safe side.

A.4.2 Measurement uncertainty contribution descriptions

A.4.2.1 Mismatch uncertainty

If the same chain configuration (e.g. including the measurement receiver; the measurement antenna and other elements) is used in both stages, the uncertainty is considered systematic and constant \rightarrow 0.00dB value.

If it is not the case, this uncertainty contribution has to be considered and determined by the following methods.

A.4.2.1.1 Mismatch uncertainty between measurement receiver / communication tester and the measurement antenna

In a measurement configuration, when two elements (devices, networks...) are connected, if the matching is not ideal, there is an uncertainty in the RF level signal passing through the connection. The magnitude of the uncertainty depends on the VSWR at the junction of the two connectors. In practical measurement system there are probably several connections in a test set-up, they will all interact and contribute to the combined mismatch uncertainty.

The total combined mismatch uncertainty is composed of 2 parts:

1. The mismatch through the connector between two elements.
2. The mismatch due to the interaction between two elements.

A.4.2.1.1.1 Mismatch uncertainty through the connector between two elements

Hereunder, a measurement configuration:

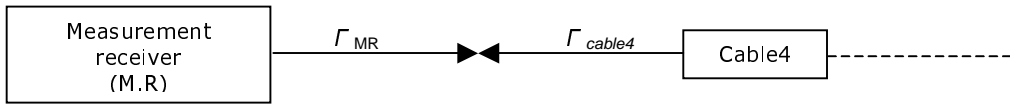

Figure A.4.2.1.1.1-1: Mismatch uncertainty through the connector

Γ_{MR} is the complex reflection coefficient of the Measurement Receiver. This term is also applicable to the communication tester.

Γ_{cable4} is the complex reflection coefficient of the cable4.

S_{21} is the forward gain in the network between the two reflection coefficients of interest.

S_{12} is the backward gain in the network between the two reflection coefficients of interest.

Note that S_{21} and S_{12} are set to 1 if the two parts are directly connected.

The uncertainty limits of the mismatch are calculated by means of the following formula (equation 6.1 of [5]):

$$\text{Mismatch limits}(\% \text{ voltage}) = |\Gamma_{MR}| \cdot |\Gamma_{cable4}| \cdot |S_{21}| \cdot |S_{12}| \cdot 100$$

These mismatch limits are divided by $\sqrt{2}$ (equation 6.2 of [5]) because of the U-shaped distribution of the mismatch uncertainty and give the following standard uncertainty:

$$U_{mismatch}(\% \text{ voltage}) = \frac{|\Gamma_{MR}| \cdot |\Gamma_{cable4}| \cdot |S_{21}| \cdot |S_{12}| \cdot 100}{\sqrt{2}}$$

To convert this standard uncertainty in dB, divide it by the standard uncertainty conversion factor (table 1 of [5]):

$$U_{mismatch}(\text{dB}) = \frac{|\Gamma_{MR}| \cdot |\Gamma_{cable4}| \cdot |S_{21}| \cdot |S_{12}| \cdot 100}{\sqrt{2} \cdot 11.5}$$

A.4.2.1.1.2 Mismatch uncertainty due to the interaction of several elements

It was previously shown how to determine the mismatch uncertainty between two elements through the junction (connector). Now, another type of mismatch uncertainty is introduced, which is a result of the interaction between several elements.

Hereunder, a measurement configuration:

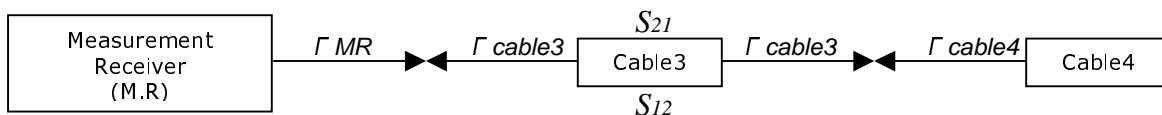

Figure A.4.2.1.1.2-1: Mismatch uncertainty due to the interaction of several elements

Firstly, the mismatch uncertainty between junctions of the elements is determined:

Between the MR and the cable3:

$$U_{mismatch1}(\text{dB}) = \frac{|\Gamma_{MR}| \cdot |\Gamma_{cable3}| \cdot |S_{21}| \cdot |S_{12}| \cdot 100}{\sqrt{2} \cdot 11.5}$$

Between the cable3 and the cable4:

$$U_{mismatch2}(\text{dB}) = \frac{|\Gamma_{cable3}| \cdot |\Gamma_{cable4}| \cdot |S_{21}| \cdot |S_{12}| \cdot 100}{\sqrt{2} \cdot 11.5}$$

$|S_{21}|$ and $|S_{12}|$ are set to 1 because there is no element between cable3 and cable 4.

$$U_{mismatch1}(\text{dB}) = \frac{|\Gamma_{MR}| \cdot |\Gamma_{cable3}| \cdot 100}{\sqrt{2} \cdot 11.5}$$

$$U_{mismatch2}(\text{dB}) = \frac{|\Gamma_{cable3}| \cdot |\Gamma_{cable4}| \cdot 100}{\sqrt{2} \cdot 11.5}$$

Each mismatch uncertainty due to the interaction between the measurement receiver and the cable4 is determined by means of the following formula:

$$U_{mismatch_interaction1}(\text{dB}) = \frac{|\Gamma_{MR}| \cdot |\Gamma_{cable4}| \cdot |S_{21cable3}| \cdot |S_{12cable3}| \cdot 100}{\sqrt{2} \cdot 11.5}$$

$|S_{21}|$ and $|S_{12}|$ are equal and correspond to the cable3 attenuation.

$$U_{mismatch_interaction1}(\text{dB}) = \frac{|\Gamma_{MR}| \cdot |\Gamma_{cable4}| \cdot |S_{21cable3}|^2 \cdot 100}{\sqrt{2} \cdot 11.5}$$

The following measurement configuration is considered in the general case:



Figure A.4.2.1.1.2-2: Mismatch uncertainty measurement configuration

In the general case, this uncertainty contribution can be calculated by:

$$U_{mismatch_interactionN}(\text{dB}) = \frac{|\Gamma_{MR}| \cdot |\Gamma_{antenna}| \cdot |S_{21cable1}| \cdot |S_{12cable1}| \cdot \dots \cdot |S_{21cableN}| \cdot |S_{12cableN}| \cdot 100}{\sqrt{2} \cdot 11.5}$$

$|S_{21}| = |S_{12}|$ for passive elements (cables...)

$$U_{mismatch_interactionN}(\text{dB}) = \frac{|\Gamma_{MR}| \cdot |\Gamma_{antenna}| \cdot |S_{21cable1}|^2 \cdot \dots \cdot |S_{21cableN}|^2 \cdot 100}{\sqrt{2} \cdot 11.5}$$

A.4.2.1.1.3 Total combined mismatch uncertainty

The two kinds of mismatch uncertainty contributions are combined by the root-sum-squares (RSS) method to derive the total combined mismatch uncertainty.

The total combined mismatch uncertainty is equal to:

$$\sqrt{U_{mismatch1}^2 + \dots + U_{mismatchN}^2 + U_{mismatch_interaction1}^2 + \dots + U_{mismatch_interactionN}^2}$$

This formula shows that the uncertainty is frequency dependent by the way of the forward and the backward gains in the network between the two components. The uncertainty upon $|S_{21}|$ and $|S_{12}|$ increases with frequency.

Note that for an anechoic chamber, horn antennas are frequently used as measurement antennas. There are two kinds of horn antennas: single-polarized and dual-polarized. With the second one, it is possible to measure the co-polarized and cross-polarized signals without any movement of the measurement antenna, which reduces the cable antenna uncertainty contribution and improves the measurement stability.

To conduct the signals to the measurement receiver, the measurement system configuration using a dual-polarized horn antenna has to be completed with an RF Relay. This device will include new mismatch uncertainty contributions, which

have to be determined with the previously presented calculation methods, completed by the RF relay parameters contributions, and described in the following.

A.4.2.1.2 Mismatch uncertainty of the RF relay

If the same receiver chain configuration (including the measurement receiver; the measurement antenna and other elements) is used in both stages, the uncertainty is considered systematic and constant → 0.00dB value.

If it is not the case, this uncertainty contribution has to be considered and determined by the following method.

The following figure describes the RF Relay with its S-parameters and the complex reflection coefficient of the inputs and output:

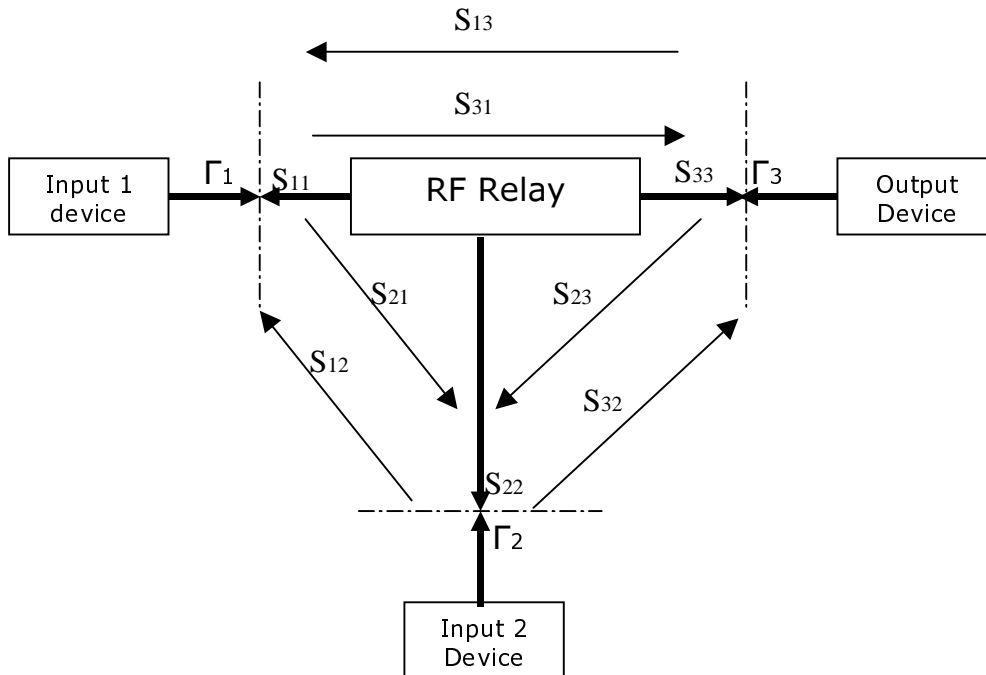

Figure A.4.2.1.2-1: Mismatch uncertainty of the RF relay

The RF relay is used to switchover the cross and direct polarization signals from the measurement antenna. To determine RF Relay mismatch uncertainty contributions, reflection coefficients for each port and the cross-talk attenuation have to be known.

The total combined mismatch uncertainty is composed of two parts:

1. The mismatch uncertainty contributions when the RF Relay switches on the direct polarization signal
2. The mismatch uncertainty contributions when the RF Relay switches on the cross-polarization signal

Each part is composed of two types of uncertainties introduced in the previous paragraph: the mismatch through the connector between two elements and the mismatch due to the interaction between several elements.

A.4.2.1.2.1 First part: RF Relay switched on the co-polarized signal

A.4.2.1.2.1.1 The mismatch through the connector between two elements

Between the Input1 and the port1:

$$U_{mismatch1}(\text{dB}) = \frac{|\Gamma_1| \cdot |S_{11}| \cdot 100}{\sqrt{2} \cdot 11.5}$$

Between the port3 and the Output:

$$U_{mismatch2}(\text{dB}) = \frac{|F_3| \cdot |S_{33}| \cdot 100}{\sqrt{2} \cdot 11.5}$$

Between the Input2 and the port2:

The RF Relay switchovers on the direct polarization signal. As a result, there is no mismatch uncertainty contribution.

A.4.2.1.2.1.2 Mismatch due to the interaction between two elements or more

Between the Input1 and the Output:

$$U_{mismatch_interaction1}(\text{dB}) = \frac{|F_1| \cdot |F_3| \cdot |S_{31}| \cdot |S_{13}| \cdot 100}{\sqrt{2} \cdot 11.5}$$

Between the Input1 and the Input2:

$$U_{mismatch_interaction2}(\text{dB}) = \frac{|F_1| \cdot |F_2| \cdot |S_{21}| \cdot |S_{12}| \cdot 100}{\sqrt{2} \cdot 11.5}$$

The RF Relay switchovers on the cross-polarization signal. As a result, this uncertainty contribution is usually disregarded because of the high crosstalk attenuation which is characterized by $|S_{21}|$ and $|S_{12}|$ S-parameters. If the crosstalk attenuation is low, this uncertainty contribution has to be considered.

Between the Input2 and the Output:

$$U_{mismatch_interaction3}(\text{dB}) = \frac{|F_2| \cdot |F_3| \cdot |S_{23}| \cdot |S_{32}| \cdot 100}{\sqrt{2} \cdot 11.5}$$

The RF Relay switchovers on the cross polarization signal. As a result; this uncertainty contribution is usually disregarded because of the high cross-talk attenuation, which is characterized by $|S_{23}|$ and $|S_{32}|$ S-parameters. If the crosstalk attenuation is low, this uncertainty contribution has to be considered.

A.4.2.1.2.2 Second part: RF relay switched on the cross-polarized signal

A.4.2.1.2.2.1 The mismatch through the connector between two elements

Between the Input1 and the port1: the RF Relay switchovers on the direct polarization signal. As a result, there is no mismatch uncertainty contribution.

Between the port3 and the Output:

$$U_{mismatch3}(\text{dB}) = \frac{|F_3| \cdot |S_{33}| \cdot 100}{\sqrt{2} \cdot 11.5}$$

Between the Input2 and the port2:

$$U_{mismatch4}(\text{dB}) = \frac{|F_2| \cdot |S_{22}| \cdot 100}{\sqrt{2} \cdot 11.5}$$

A.4.2.1.2.2.2 Mismatch due to the interaction between two elements or more

Between the Input1 and the Output:

$$U_{mismatch_interaction4}(\text{dB}) = \frac{|F_1| \cdot |F_3| \cdot |S_{31}| \cdot |S_{13}| \cdot 100}{\sqrt{2} \cdot 11.5}$$

The RF Relay switchovers on the cross-polarization signal. As a result, this uncertainty contribution is usually disregarded because of the high crosstalk attenuation which is characterized by $|S_{31}|$ and $|S_{13}|$ S-parameters. If the crosstalk attenuation is low, this uncertainty contribution has to be considered.

Between the Input1 and the Input2:

$$U_{mismatch_interaction5}(\text{dB}) = \frac{|F_1| \cdot |F_2| \cdot |S_{21}| \cdot |S_{12}| \cdot 100}{\sqrt{2} \cdot 11.5}$$

The RF Relay switchovers on the cross-polarization signal. As a result, this uncertainty contribution is usually disregarded because of the high crosstalk attenuation which is characterized by $|S_{21}|$ and $|S_{12}|$ S-parameters. If the crosstalk attenuation is low, this uncertainty contribution has to be considered.

Between the Input2 and the Output:

$$U_{mismatch_interaction6}(\text{dB}) = \frac{|F_2| \cdot |F_3| \cdot |S_{23}| \cdot |S_{32}| \cdot 100}{\sqrt{2} \cdot 11.5}$$

A.4.2.1.2.3 Total combined mismatch uncertainty

Each non-zero mismatch uncertainty contribution from both parts (RF Relay switched on the cross and direct polarization signal) are combined by the root-sum-squares (RSS) method to derive the total combined mismatch uncertainty.

The total combined mismatch uncertainty is equal to:

$$\sqrt{U_{mismatch1}^2 + \dots + U_{mismatchN}^2 + U_{mismatch_interaction1}^2 + \dots + U_{mismatch_interactionN}^2}$$

If a RF Relay is used to drive the cross and direct polarization signals from the dual-polarized antenna, this total combined mismatch uncertainty has to be added with all the uncertainty measurement contributions for the total combined measurement uncertainty.

A.4.2.2 Insertion loss

A.4.2.2.1 Insertion loss of the measurement antenna cable

If the measurement antenna cable does not move between the calibration and the DUT measurement stage, the uncertainty due to the insertion loss of the cable is assumed to be systematic. Moreover, this uncertainty is common and constant in both stages and that is why this leads to 0.00dB value.

If a different cable is used in the calibration measurement and in the DUT measurement, and the difference of the insertion loss is used in the calculations, then the overall combined standard uncertainty of the insertion loss measurement should be used in the uncertainty budget. The distribution of this uncertainty is assumed to be rectangular, in which case the standard uncertainty can be calculated as the maximum value divided by $\sqrt{3}$.

A.4.2.2.2 Insertion loss of the measurement antenna attenuator (if used)

See Insertion loss of the measurement antenna cable

If the measurement antenna attenuator is used in both stages, the uncertainty is considered systematic and constant → 0.00dB value.

A.4.2.2.3 Insertion loss of the RF relays (if used)

See Insertion loss of the measurement antenna cable.

If the RF relay is used in both stages, the uncertainty is considered systematic and constant → 0.00dB value.

A.4.2.2.4 Insertion loss: calibration antenna feed cable

The feed cable of the calibration antenna only appears in Stage 1. As a result, this uncertainty has to be considered.

This uncertainty will be measured or calculated from the manufacturer's data in logs with a rectangular distribution (see clause 5.1.2 in [5]).

A.4.2.2.5 Insertion loss: calibration antenna attenuator (if used)

If a calibration antenna attenuator is used, it only appears in Stage 1. As a result, this uncertainty has to be considered.

This uncertainty will be calculated from the manufacturer's data in logs with a rectangular distribution (see clause 5.1.2 in [5]).

A.4.2.3 Influence of the antenna cable

A.4.2.3.1 Measurement antenna cable

If the measurement antenna is directional (i.e. peak gain $>+5$ dBi e.g. horn, LPDA, etc.) and the same measurement antenna cable configuration is used for both stages, the uncertainty is considered systematic and constant $\rightarrow 0.00$ dB value.

A.4.2.3.2 Calibration antenna cable

If an efficiency calibration is performed, influence of the calibration antenna feed cable can be assumed to be negligible, due to data averaging.

In the case of gain calibration, the influence of the calibration antenna feed cable shall be assessed by measurements. A gain calibration measurement is repeated with a reasonably differing routing of the feed cable. Largest difference between the results is entered to the uncertainty budget with a rectangular distribution.

A.4.2.4 Measurement receiver: uncertainty of the absolute level

The receiving device is used to measure the received signal level in TRP tests either as an absolute level or as a relative level. Receiving device used is typically a communication tester, spectrum analyser (SA), or power meter (PM). Generally, there occurs an uncertainty contribution from limited absolute level accuracy and non-linearity.

This uncertainty will be determined from the manufacturer's datasheet and the distribution used (see clause 5.1.2 in [5]) shall match that provided in the datasheet which are commonly quoting MUs/accuracies with a "95% confidence level" and/or a "coverage factor of 2". In the absence of a declared distribution in the datasheet, the rectangular distribution should be used. Given the wide bandwidths of the modulated signal transmitted during the testing, the level flatness and not just the CW level accuracy shall be considered.

A.4.2.5 Communication tester: uncertainty of the absolute level

The transmitter device (typically a communication tester or BS simulator) is used to drive a signal to the measurement antenna in sensitivity tests either as an absolute level or as a relative level. Receiving device used is the UE. Generally, there occurs uncertainty contribution from limited absolute level accuracy and non-linearity of the communication tester.

For practical reasons, the calibration measurement (Stage 1) should be only performed with the measurement antenna as a receiver. Hence, the uncertainty on the absolute level of the transmitter device cannot be assumed as systematic. This uncertainty will be determined from the manufacturer's datasheet and the distribution used (see clause 5.1.2 in [5]) shall match that provided in the datasheet which are commonly quoting MUs/accuracies with a "95% confidence level" and/or a "coverage factor of 2". In the absence of a declared distribution in the datasheet, the rectangular distribution should be used. Furthermore, the uncertainty of the non-linearity of the device is included in the absolute level uncertainty. Given the wide bandwidths of the modulated signal received during the testing, the level flatness and not just the CW level accuracy shall be taken into account.

A.4.2.6 Sensitivity measurement: output level step resolution
When output power of the communication tester is swept to reach the throughput target that defines the sensitivity threshold, used power step resolution creates this uncertainty. Output power step used in the sensitivity measurement is divided by factor 2 and then a rectangular distribution applied to obtain the uncertainty.

A.4.2.6 Sensitivity measurement: output level step resolution

When output power of the communication tester is swept to reach the throughput target that defines the sensitivity threshold, the final power step resolution represents an asymmetric uncertainty contribution that can be corrected since

this uncertainty is device and test system independent. The lab shall correct the TRS results by $-0.5 \cdot \text{output level step resolution}$ of the final power step search and note the correction in the test report.

Alternatively, if the alternate EIS search procedure is applied as described in A.3.3.3.1 to assess the EIS at each grid point, no correction of TRS shall be applied and the no uncertainty contribution shall be considered.

Please note that the digital error rater uncertainty is included in the random uncertainty, see A.4.2.13.

A.4.2.7 Measurement distance

The uncertainty contribution from a finite measurement distance is estimated differently for Stage 1 and Stage 2.

A.4.2.7.1 Offset of phase centre from axis(es) of rotation

A.4.2.7.1.1 Offset of DUT phase centre from axis(es) of rotation

In all the DUT measurements (Stage 2) defined in this test procedure, the DUT and head phantom combination is rotated about the ear reference point of SAM phantom, which is also assumed to be the location of the phase centre in both angular directions of the measurements.

For some positioning systems this may be practically impossible in which case a measurement uncertainty contribution can arise because the phase centre will rotate on a non-zero radius about the centre of rotation, thereby giving a variable measurement distance. Data averaging process may lead to a partial self-cancel of this uncertainty.

The uncertainty limits of this effect are calculated by means of the following formula (u_{j22} of [6]):

$$\text{Phase centre limits(\%)} = \frac{\pm \text{estimated offset from the axis of rotation}}{\text{range length}} \cdot 100$$

To convert this standard uncertainty in dB, we divide it by the standard uncertainty conversion factor (table 1 of [5]):

$$U_{\text{phase centre offset}}(\text{dB}) = \frac{\pm \text{estimated offset from the axis of rotation}}{\text{range length} \cdot 11.5} \cdot 100$$

Because of the phase centre can be anywhere between the offset limits, the distribution is assumed to have a rectangular distribution.

For hand phantom measurements, the device is aligned with the centre of the quiet zone; thus, this MU element is not applicable to hand phantoms and the MU can be considered 0 dB.

A.4.2.7.1.2 Offset of calibration antenna phase centre from axis(es) of rotation

If a gain calibration is performed in Stage 1 with a directive antenna (e.g. horn antenna), the uncertainty contribution of calibration antenna's phase centre displacement is estimated by means of the following formula (u_{j21} of [6]):

$$\text{Phase centre limits(\%)} = \frac{\pm \text{maximum dimension of the antenna}}{2 \cdot \text{range length}} \cdot 100$$

To convert this standard uncertainty in dB, we divide it by the standard uncertainty conversion factor (table 1 of [5]):

$$U_{\text{phase centre offset}}(\text{dB}) = \frac{\pm \text{maximum dimension of the antenna}}{2 \cdot \text{range length} \cdot 11.5} \cdot 100$$

Because the phase centre can be anywhere between the offset limits, the distribution is assumed to have a rectangular distribution.

If a gain calibration is performed in Stage 1 with omnidirectional calibration antenna (e.g. sleeve dipoles), uncertainty should be 0.00 dB provided that care is taken in their positioning since the phase centre are easily identifiable.

For an efficiency calibration with an omnidirectional calibration antenna, the $U_{phase\ centre\ offset}$ is calculated similarly as for gain calibration but the uncertainty may be divided by factor 2. This is due to correcting impact of data averaging in this type of calibration.

A.4.2.7.2 Mutual coupling

In measurement of radio performances of UMTS mobile phones in speech mode, the mutual coupling uncertainty for this frequency band is a 0.00dB value (see annex A.2 in [7]).

The 0.00dB value can be extended for NR FR1 band frequencies.

A.4.2.7.3 Phase curvature

This uncertainty originates from the finite far-field measurement distance, which causes phase curvature across the DUT. If the minimum measurement distance is respected, this error is assumed to be negligible.

A.4.2.8 Quality of quiet zone

The uncertainty contribution due to unwanted reflections and obstructions within the anechoic chamber, including imperfect absorber treatments and the impact of positioning equipment support structure, is determined from data acquired using the ripple test methodology in clause A.3.7. This data consists of single-axis pattern cuts that represent the sum of direct and reflected rays from a highly symmetrical omnidirectional radiation pattern measured at various points throughout the test volume. The data must be measured in sufficient spatial or angular resolution to accurately capture the peaks and nulls of the pattern to within a small fraction of the overall ripple contribution. In general, the worst-case peak-to-null ripple will reflect the potential error in a peak EIRP or EIS measurement for an omnidirectional DUT pattern located anywhere within the test volume. Note however that nulls in the pattern can exhibit considerably larger errors due to reflected signals being stronger than the line-of-sight signal from the null.

When measuring the range path loss in Stage 1 using a dipole pattern, the associated measurement uncertainty may be determined from the peak-to-null ripple, after relative path loss compensation, of a single radial offset ripple test, where the range is configured as for range calibration (e.g. with any extraneous support structure removed) using a rectangular distribution.

For spherically integrated quantities such as TRP and TRS, the peak-to-null ripple would overestimate the measurement uncertainty due to the inherent averaging of the various peaks and nulls as the spherical pattern is integrated. In this case, the surface standard deviation (SSD) [9] is used to obtain a statistical representation of the expected impact of ripple on the integrated power from an isotropic radiator placed anywhere within the test volume. Due to the impracticality of maintaining a constant path loss reference between individual ripple test cuts, each resultant pattern is treated individually and then the worst case SSD result is chosen as the standard uncertainty of the quiet zone.

For the phi-axis ripple tests, the pattern can be considered an equatorial ($\theta = 90^\circ$) cut of the isotropic pattern where every point has equal weighting on an evenly spaced spherical surface. Thus, the standard deviation of the single cut should be equivalent to the standard deviation of the entire spherical surface. Defining p_k as the k th ripple measurement point in linear power units ($p_k = 10^{(P_k(\text{dB})/10)}$), and \bar{p} as the average of all p_k values in the associated ripple test, then the standard deviation of the corresponding cut is given by:

$$s(p_k) = \sqrt{\frac{1}{(N-1)} \sum_{k=0}^{N-1} \left(\frac{p_k}{\bar{p}} - 1 \right)^2}$$

On the theta-axis ripple test each ripple test cut can be considered as a great circle cut through an isotropic pattern with the symmetrical distortions that would be produced by revolving the pattern about the phi (0-180°) axis. Thus, it becomes apparent that ripple near the poles impacts a smaller total surface area on the sphere than that near $\theta = 90^\circ$ and 270° . In this case, $\sin(\theta)$ weighting is used to generate the spherical surface weighted standard deviation as:

$$s(p_k) = \sqrt{\frac{1}{N-1} \sum_{k=0}^{N-1} \left[\left(\frac{p_k}{\bar{p}} - 1 \right) \sin(\theta_k) \right]^2}$$

Note that this equation simplifies to the previous equation when $\theta = 90^\circ$, so the two formulations are in fact the same, regardless of which orientation of the ripple test is used.

The standard uncertainty for the quiet zone ripple contribution to the TRP/TRS measurement is then given by the maximum SSD from all of the ripple test measurements.

A.4.2.9 DUT Tx-power drift

A single point power reference measurement in the beginning and at the end of the measurement procedure is recommended to monitor the power drift of the DUT. Based on TX-power drift measurements for typical 3G UE, an uncertainty of 0.2 dB shall be entered to uncertainty budget with a rectangular distribution. If the drift measurement indicates larger drift, the actual drift shall be included to uncertainty.

In order to minimize Tx-power drift error it is recommended to interleave sensitivity and power measurement of multiple channels. This spreads the measurements over a longer period, which helps to average the drift of the TX-power.

Typical TX-power drifts of 3G UE, measured in a single angular point, DUT placed against phantom head are shown in Figure A.4.2.9-1.

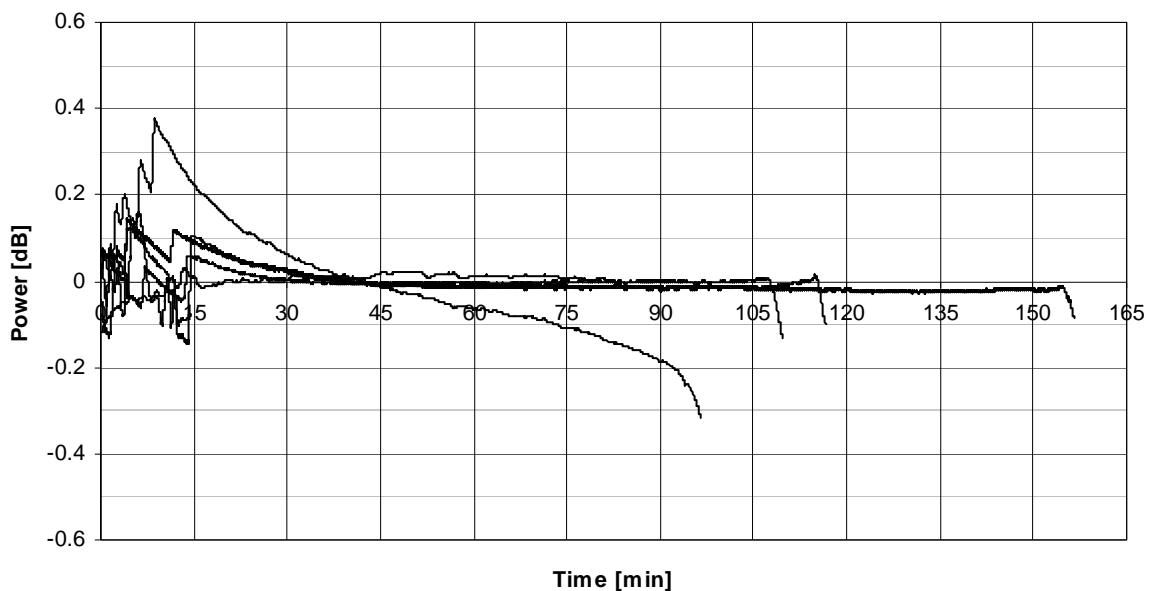

Figure A.4.2.9-1: Output power variation of typical 3G UE during battery life

A.4.2.10 DUT sensitivity drift

Due to statistical uncertainty of sensitivity measurement, drift in the TRS cannot be monitored similarly to TRP. An uncertainty value of 0.2dB can be used with a rectangular distribution, or the TRS drift should be measured, with a setup corresponding to the actual TRS measurement.

A.4.2.11 Uncertainty related to the use of phantoms

The following elements of uncertainty contributions (when applicable) are combined by the root-sum-squares (RSS) method to derive the total combined uncertainty related to the use of phantoms.

A.4.2.11.1 Uncertainty from using different types of SAM phantom

This uncertainty contribution originates from the fact that different laboratories may use the two different versions of SAM head: the SAM head phantom or the SAM phantom including the head and the shoulders. The standard SAM head is the specified phantom. However, the use of the other type of SAM is also allowed with the requirement that the resulting uncertainty contribution is considered in the uncertainty budget.

A.4.2.11.2 Simulated tissue liquid uncertainty

This uncertainty will occur, if the laboratory uses a liquid which has dielectric parameters deviating more than $\pm 15\%$ of the target parameters.

A.4.2.11.3 Uncertainty of dielectric properties and shape of the hand phantom

The hand phantom contributes to OTA measurement uncertainty due to the manufacturing tolerances of its dielectric properties and shape. The dielectric properties on the surface of the hand may differ from those of its interior, so both are included in the evaluation. The moulded exterior surface of the hand shall be measured directly with an open-ended coaxial probe. The interior hand material is evaluated indirectly, by substituting a cube-shaped sample moulded from the same material and having some exterior surfaces removed. Following procedure will be used to evaluate the dielectric properties of the hand phantom;

1. Each hand shall be manufactured together with a reference cube of the same material. The sides of the reference cube shall be not less than 40 mm in length.
2. The moulded surface on three orthogonal sides of the cube shall be sliced away to a depth of at least 3 mm, in order to expose interior material for evaluation. The remaining three sides of the cube shall be left untreated.
3. Relative permittivity and conductivity shall be measured at ten different points on each of the three cut, exposed surfaces of the reference cube, and the combined interior averages (ε_{int_avg} , σ_{int_avg} , 30 points) and standard deviations (ε_{int_std} , σ_{int_std} , 30 points) shall be calculated. Individual interior averages for each of these three sides (ε_{int_i} , σ_{int_i} , 10 points) shall also be calculated.
4. Relative permittivity and conductivity shall be measured at ten points on the hand phantom exterior. A measurement point shall be located to each fingertip or as close to the tip as applicable. One measurement point shall be located to the back of the hand and one to the inner surface of wrist area. The exterior averages (ε_{ext_avg} , σ_{ext_avg} , 10 points) and standard deviations (ε_{ext_std} , σ_{ext_std} , 10 points) calculated accordingly.
5. The total averages (ε_{avg} , σ_{avg}) shall be calculated as the average of exterior and interior values by either evaluating all data points or using equations :

$$\varepsilon_{avg} = \frac{\varepsilon_{ext_avg} + 3 \cdot \varepsilon_{int_avg}}{4}$$

$$\sigma_{avg} = \frac{\sigma_{ext_avg} + 3 \cdot \sigma_{int_avg}}{4}$$

6. The total standard deviations (ε_{std} , σ_{std}) shall be calculated as the statistical combination of exterior and interior values by either evaluating all data points or using equations:

$$\varepsilon_{std} = \sqrt{\frac{1}{4}(\varepsilon_{ext_std}^2 + \varepsilon_{ext_avg}^2 + 3 * (\varepsilon_{int_std}^2 + \varepsilon_{int_avg}^2)) - \varepsilon_{avg}^2}$$

$$\sigma_{std} = \sqrt{\frac{1}{4}(\sigma_{ext_std}^2 + \sigma_{ext_avg}^2 + 3 * (\sigma_{int_std}^2 + \sigma_{int_avg}^2)) - \sigma_{avg}^2}$$

7. The hands are acceptable for radiated performance testing, i.e., meet the minimal requirements, if
 - a. ε_{avg} deviates by less than 15% from the target values
 - b. σ_{avg} deviates by less than 25% from the target values

- c. the difference between the averaged permittivity of each 10-point interior surface ε_{int_avg} deviates by less than 10% and ε_{ext_avg} by less than 20% from the total average ε_{avg}
 - d. the difference between the averaged conductivity of each 10-point interior surface σ_{int_avg} deviates by less than 20% and σ_{ext_avg} by less than 30% from the total average σ_{avg}
 - e. the standard deviation of the combined measurements (30 interior points and 10 exterior points) is less than 20% for permittivity ε_{std} and less than 40% for conductivity σ_{std}
8. For the hands meeting the minimal requirements of step 7, the following approximations shall be used to determine the hand uncertainty due to dielectric properties.

$$U_{\varepsilon}(\text{dB}) = c_1 \cdot \left[10 \log_{10} \left(1 + \left| \frac{\sqrt{\Delta\varepsilon_{avg}^2 + \varepsilon_{unc}^2 + (a_1\varepsilon_{std})^2}}{\varepsilon} \right| \right) \right]$$

$$U_{\sigma}[\text{dB}] = c_2 \cdot \left[10 \log_{10} \left(1 + \left| \frac{\sqrt{\Delta\sigma_{avg}^2 + \sigma_{unc}^2 + (a_1\sigma_{std})^2}}{\varepsilon} \right| \right) \right]$$

$\Delta\varepsilon_{avg}$, $\Delta\sigma_{avg}$, ε_{std} , σ_{std} are the values determined as defined above and ε_{unc} and σ_{unc} are expanded measurement uncertainties ($k = 2$) of the dielectric parameter measurement method. The cube will be provided together with the hand such that the user can evaluate if the interior (cube) properties of the hand has degenerated over time by performing the test above. Coefficient $c_1 = 0.78$, $c_2 = 0.39$ and $a_1 = 0.50$ were determined by numeric simulations.

In case the hand phantoms are manufactured within CAD models, the tolerance is 2% and therefore the effects shape errors are negligible. If the tolerance is larger, a numerical study must be conducted.

The assessment of uncertainties for the Wide Grip hand phantom defined in CTIA Certification OTA Test Plan 01.72 Section 2.2.13 [12], is further detailed in CTIA Certification OTA Test Plan 01.70 Section 3 [8]. Values are from the CTIA Certification Test Plan for Wireless Device Over-the-Air Performance © CTIA Certification. Reproduced with permission.

A.4.2.11.4 Uncertainty from using different types of Laptop Ground Plane phantom

This uncertainty contribution originates from the fact that different laboratories may use different variations of Laptop Ground Plane phantom. The standard Laptop Ground Plane is the specified phantom.

A.4.2.11.5 Positioning Uncertainty from using Phantoms

Some uncertainty also occurs from the positioning of the DUT against the SAM phantom, as the DUT cannot be attached exactly in the same way every time. This uncertainty depends on how much the DUT's positioning against the SAM phantom and hand phantoms varies from the specified testing positions. It is noted that the uncertainty of the phone positioning depends on the phone holder and the measurement operator and is in fact difficult to distinguish from random uncertainty. Some uncertainty also occurs from the positioning of the DUT plugged into the Laptop Ground Plane phantom, as the DUT may not be plugged into the USB connector and positioned exactly in the same way every time. This uncertainty depends on how much the DUT's position plugged into the Laptop Ground Plane phantom varies from the specified plug-in position. Therefore, the positioning uncertainty is included in random uncertainty.

To estimate this uncertainty for the SAM phantom, it is suggested to perform at least five evaluations of TRP/TRS whereby the device shall be dismantled and newly positioned with a fully charged battery before each test. This measurement set has to be carried out in mid channel of lowest and highest frequency bands utilized by the testing lab, for at least three phones with different type of mechanical design. The values have to be normalized by the mean for each measurement set. As a result, the uncertainty contribution entered to uncertainty budget is the difference between the maximum and minimum normalized values.

With head and hand phantoms, random uncertainty evaluation may be done separately for each measurement configuration i.e. head only, browsing mode or speech mode. A speech mode random uncertainty evaluation, were both head and hand phantoms are used, can reasonably be considered to be the worst-case scenario and thus random uncertainties in other configurations to be less.

To estimate this uncertainty for the Laptop Ground Plane phantom, it is suggested to perform at least five evaluations of TRP/TRS for the plug-in position whereby the device shall be dismantled and newly positioned before each test. This

measurement set has to be carried out in mid channel of lowest and highest frequency bands utilized by the testing lab, for at least three USBs with different type of mechanical design. The values have to be normalized by the mean for each measurement set. As a result, the uncertainty contribution entered to uncertainty budget is the difference between the maximum and minimum normalized value.

A.4.2.12 Coarse sampling grid

Editor's Note: Further analyses of measurement grids and impact on measurement uncertainty based on empirical data are pending.

This contributor describes the uncertainty of the measured TRP/TRS value due to the finite number of measurement grid points. Decreasing of sampling density to finite number of samples affects the measurement uncertainty. Different TRP quadratures also have an effect on the MU. The grid options for TRP/TRS with associated MUs for constant-step size grids are summarized in Table A.4.2.12-1.

Table A.4.2.12-1: Measurement grid options for TRP/TRS

Test Metric	Frequency Range	Quadrature	$\Delta\theta$ [°]	$\Delta\phi$ [°]	Min. Number of Grid Points (Note 1)	Std. Uncertainty [dB]	Mean Error [dB]
TRP	< 3GHz	sin(θ)	15	15	266	0	0
TRS			30	30	62	0.13	0
TRP		Clenshaw-Curtis	15	15	266	0	0
TRS			30	30	62	0.10	0
TRP (Note 2)			30	30	62	0.10	0
TRS (Note 2)			30	60	32	0.15	0
TRS (Note 2)			45	45	26	0.19	0
TRP	> 3GHz	sin(θ)	15	15	266	0	0
TRS			30	30	62	0.21	0
TRP		Clenshaw-Curtis	15	15	266	0	0
TRS			30	30	62	0.18	0
TRP (Note 2)			30	30	62	0.18	0
TRS (Note 2)			30	60	32	0.25	0
TRS (Note 2, 3)			45	45	27	0.23	0.08
TRS (Note 2, 4)			45	45	25	0.25	0.08

Note 1: The exact number of grid points depends on how the back pole EIRP($\theta=180^\circ$)/EIS($\theta=180^\circ$) is approximated due to obstruction and/or blocking
Note 2: The overall MU shall not be larger than the maximum MU limits if the coarsest measurement grid is adopted.
Note 3: The EIS value at 180° is determined from two 165° measurements.
Note 4: The EIS value at 180° is averaged from previous cut.

The mean error in Table A.4.2.12-1 shall be considered a systematic uncertainty that cannot be corrected and thus shall be included in the uncertainty budget table as a systematic uncertainty added to the combined expanded uncertainty.

The legacy grid with $\Delta\theta=\Delta\phi=15^\circ$ for TRP and $\Delta\theta=\Delta\phi=30^\circ$ for TRS should be considered the default measurement grid and is recommended for certification testing.

A.4.2.13 Random uncertainty

This contribution is used to account for all the unknown, unquantifiable, etc. uncertainties associated with the measurements.

Random uncertainty MU contributions are normally distributed.

The random uncertainty term, by definition, cannot be measured, or even isolated completely. However, past system definitions provide an empirical basis for a value. A fixed value of 0.25 dB (half that of FR2 SISO OTA measurements) is suggested for TRP measurements while a fixed value of 0.4 dB is suggested for TRS measurement to include a digital error rate uncertainty.

A.4.2.14 Frequency response

Test systems might not be able to ensure flat frequency response across the entire channel bandwidth required for testing (e.g. up to 100MHz for NR FR1). When a frequency response correction based on the results from the system calibration measurements in Stage 1 is not possible or practical, this uncertainty has to be considered.

This uncertainty term can be estimated as described in [8] using the following formula:

$$\varepsilon_j = 10 \log \left(\frac{\sum_{k=j-N/2}^{j+N/2} PL_k}{(N+1)PL_j} \right)$$

where ε_j is the expected relative error in the average power result for a given channel in dB, PL_j , is the linear path loss at the center frequency of the given channel, PL_k , is the linear path loss at each frequency point across the corresponding channel, and N is the number of frequency steps across a given channel bandwidth. The maximum deviation ε_j across all the possible channels in a band shall be used to estimate the required frequency response uncertainty contribution with a rectangular distribution.

This error may be removed directly at each frequency, f_j , by using the average path loss across the channel as the range loss correction rather than the path loss at the centre frequency as described in [8].

For sensitivity measurements, this effect is included in the output level step resolution.

A.4.2.15 Uncertainty of network analyser

This uncertainty includes all the uncertainties involved in the S21 measurement with a network analyser, and will be determined from the manufacturer's datasheet which is now commonly quoting MUs/accuracies with a "95% confidence level" and/or a "coverage factor of 2" and the distribution used (see clause 5.1.2 in [5]) shall match that provided in the datasheet. In the absence of a declared distribution in the datasheet, the rectangular distribution should be used.

A.4.2.16 Uncertainty of the gain/efficiency of the calibration antenna

The calibration antenna only appears in Stage 1. Therefore, the gain/efficiency uncertainty has to be considered.

This uncertainty shall come from a calibration report (which is now commonly quoting MUs/accuracies with a "95% confidence level" and/or a "coverage factor of 2") with traceability to a National Metrology Institute with measurement uncertainty budgets generated following the guidelines outlined in internationally accepted standards. In the absence of a declared distribution in the report, the rectangular distribution should be used.

A.4.3 Total Radiated Power (TRP)

A.4.3.1 Anechoic Chamber Method

The uncertainty contributions related to TRP for the Anechoic Chamber method are listed in Table A.4.3.1-1. Example uncertainty budget is presented in Table A.4.3.1-2.

Table A.4.3.1-1: Uncertainty contributions in TRP measurement for anechoic chamber method

UID	Description of uncertainty contribution	Details in clause
Stage 2: DUT measurement (Figure A.3.1-1, Figure A.3.1-2)		
1	Mismatch of receiver chain	A.4.2.1
2	Insertion loss of receiver chain	A.4.2.2
3	Influence of the measurement antenna cable	A.4.2.3
4	Measurement Receiver: uncertainty of the absolute level	A.4.2.4
5	Measurement distance	A.4.2.7.1
6	Quality of quiet zone	A.4.2.8
7	DUT Tx-power drift	A.4.2.9
8	Uncertainty related to the use of phantoms	A.4.2.11
9	Coarse sampling grid	A.4.2.12
10	Random uncertainty	A.4.2.13
11	Frequency Response	A.4.2.14
Stage 1: Calibration measurement, network analyzer method (Figure A.3.2-1)		
12	Uncertainty of network analyzer	A.4.2.15
13	Mismatch of receiver chain	A.4.2.1
14	Insertion loss of receiver chain	A.4.2.2
15	Mismatch in the connection of calibration antenna	A.4.2.1
16	Influence of the calibration antenna feed cable	A.4.2.3
17	Influence of the measurement antenna cable	A.4.2.3
18	Uncertainty of the absolute gain/ radiation efficiency of the calibration antenna	A.4.2.16
19	Measurement distance	A.4.2.7.2
20	Quality of the Quiet Zone	A.4.2.8
Systematic Errors		
21	Systematic Error related to TRP grids	A.4.2.12

Table A.4.3.1-2: Example of uncertainty budget for TRP hand only (browsing mode) measurement for anechoic chamber method for NR FR1 bands

UID	Uncertainty Source	Comment	Uncertainty Value [dB]		Prob Distr	Div	ci	Standard Uncertainty [dB]	
			Below 3GHz	Above 3GHz				Below 3GHz	Above 3GHz
Stage 2: DUT measurement									
1	Mismatch of receiver chain	$\Gamma_{\text{receiver}} < 0.33$ $\Gamma_{\text{measurement antenna}} < 0.5$ Cable attenuation > 3dB	0.26	0.26	U-shaped	1.41	1	0.18	0.18
2	Insertion loss of receiver chain	Systematic with Stage 1 (=> cancels)	0	0	Rectangular	1.73	1	0.00	0.00
3	Influence of the measurement antenna cable	Systematic with Stage 1 (=> cancels)	0	0	Rectangular	1.73	1	0.00	0.00
4	Measurement Receiver: uncertainty of the absolute level	From datasheet of communication tester or spectrum analyser.	0.42	0.54	Normal	2.00	1	0.21	0.27

5	Measurement distance	DUT is not offset for hand-only phantom testing	0	0	Rectangular	1.73	1	0.00	0.00
6	Quality of quiet zone	Surface standard deviation of power measurements in ripple test	0.5	0.5	Actual	1.00	1	0.50	0.50
7	DUT Tx-power drift	Drift	0.2	0.2	Rectangular	1.73	1	0.12	0.12
8	Uncertainty related to the use of phantoms	Material Dielectric Constant, Material Conductivity, Geometry/Shape (incl. spacer), Data Mode Fixture	0.64	0.64	Rectangular	1.73	1	0.37	0.37
9	Coarse sampling grid	Sampling grids per Table A.4.2.12-1	0	0	Actual	1.00	1	0.0	0.0
10	Random Uncertainty	Fixed MU to account for all the unknown, unquantifiable, etc. uncertainties	0.25	0.25	Normal	2.00	1	0.13	0.13
11	Frequency Response	Average path loss corrected	0	0	Rectangular	1.73	1	0.00	0.00
Stage 1: Calibration measurement, network analyzer method									
12	Uncertainty of network analyzer	From datasheet of VNA with assessed transmission coefficients	0.2	0.5	Normal	2.00	1	0.10	0.25
13	Mismatch of receiver chain	Taken into account in VNA uncertainty term	0	0	U-shaped	1.41	1	0.00	0.00
14	Insertion loss of receiver chain	Systematic with Stage 2 (=> cancels)	0	0	Rectangular	1.73	1	0.00	0.00
15	Mismatch in the connection of calibration antenna	Taken in to account in VNA setup uncertainty	0	0	U-shaped	1.41	1	0.00	0.00
16	Influence of the calibration antenna feed cable	Gain calibration with a dipole	0.3	0.3	Rectangular	1.73	1	0.17	0.17
17	Influence of the measurement antenna cable	Systematic with Stage 2 (=> cancels)	0	0	Rectangular	1.73	1	0.00	0.00
18	Uncertainty of the absolute gain/ radiation efficiency of the calibration antenna	Calibration report with traceability to a National Metrology Institute	0.58	0.58	Normal	2.00	1	0.29	0.29

19	Measurement distance	Dipole: phase centre is aligned with axis of rotation	0	0	Rectangular	1.73	1	0.00	0.00
20	Quality of the Quiet Zone	Peak-to-null ripple	0.5	0.5	Rectangular	1.73	1	0.29	0.29
Combined Standard Uncertainty [dB]								0.84	0.88
Expanded Uncertainty [dB] (Confidence interval of 95 %)								1.64	1.73
21	Systematic Error related to TRP grids	mean error	0	0	Actual	1.00	1	0.00	0.00
Total Expanded Uncertainty [dB] (Confidence interval of 95 %)								1.64	1.73

A.4.4 Total Radiated Sensitivity (TRS)

A.4.4.1 Anechoic Chamber Method

The uncertainty contributions related to TRS for the Anechoic Chamber method are listed in Table A.4.4.1-1. Example uncertainty budget is presented in Table A.4.4.1-2.

Table A.4.4.1-1: Uncertainty contributions in TRS measurement for anechoic chamber method

UID	Description of uncertainty contribution	Details in clause
Stage 2: DUT measurement (Figure A.3.1-1, Figure A.3.1-2)		
1	Mismatch of transmitter chain	A.4.2.1
2	Insertion loss of transmitter chain	A.4.2.2
3	Influence of the measurement antenna cable	A.4.2.3
4	Communication Tester: uncertainty of the absolute output level	A.4.2.5
5	Sensitivity measurement: output level step resolution	A.4.2.6
6	Measurement distance	A.4.2.7.1
7	Quality of quiet zone	A.4.2.8
8	DUT sensitivity drift	A.4.2.10
9	Uncertainty related to the use of phantoms	A.4.2.11
10	Coarse sampling grid	A.4.2.12
11	Random uncertainty	A.4.2.13
12	Frequency Response	A.4.2.14
Stage 1: Calibration measurement, network analyzer method (Figure A.3.2-1)		
13	Uncertainty of network analyzer	A.4.2.15
14	Mismatch of transmitter chain	A.4.2.1
15	Insertion loss of transmitter chain	A.4.2.2
16	Mismatch in the connection of calibration antenna	A.4.2.1
17	Influence of the calibration antenna feed cable	A.4.2.3
18	Influence of the measurement antenna cable	A.4.2.3
19	Uncertainty of the absolute gain/radiation efficiency of the calibration antenna	A.4.2.16
20	Measurement distance	A.4.2.7.2
21	Quality of quiet zone	A.4.2.8
Systematic Errors		
22	Systematic Error related to TRS grids	A.4.2.12

Table A.4.4.1-2: Example of uncertainty budget for TRS hand only (browsing mode) measurement for anechoic chamber method for NR FR1 bands

UID	Uncertainty Source	Comment	Uncertainty Value [dB]		Prob Distr	Div	ci	Standard Uncertainty [dB]	
			Below 3GHz	Above 3GHz				Below 3GHz	Above 3GHz
Stage 2: DUT measurement									
1	Mismatch of transmitter chain	$\Gamma_{\text{receiver}} < 0.29$ $\Gamma_{\text{measurement antenna}} < 0.5$ Cable attenuation > 3dB	0.22	0.22	U-shaped	1.41	1	0.16	0.16
2	Insertion loss of transmitter chain	Systematic with Stage 1 (=> cancels)	0	0	Rectangular	1.73	1	0.00	0.00
3	Influence of the measurement antenna cable	Systematic with Stage 1 (=> cancels)	0	0	Rectangular	1.73	1	0.00	0.00
4	Communication Tester: uncertainty of the absolute output level	From datasheet of communication tester	1.30	1.30	Normal	2.00	1	0.65	0.65
5	Sensitivity measurement: output level step resolution	Systematic error that can be corrected	0	0	Rectangular	1.73	1	0.00	0.00

6	Measurement distance	DUT is not offset for hand-only phantom testing	0	0	Rectangular	1.73	1	0	0
7	Quality of quiet zone	Surface standard deviation of power measurements in ripple test	0.5	0.5	Actual	1.00	1	0.50	0.50
8	DUT sensitivity drift	Drift measurement	0.2	0.2	Rectangular	1.73	1	0.12	0.12
9	Uncertainty related to the use of phantoms	Material Dielectric Constant, Material Conductivity, Geometry/Shape (incl. spacer), Data Mode Fixture	0.64	0.64	Rectangular	1.73	1	0.37	0.37
10	Coarse sampling grid	Sampling grids per Table A.4.2.12-1	0.10	0.18	Actual	1.00	1	0.10	0.18
11	Random uncertainty	Fixed MU to account for all the unknown, unquantifiable, etc. uncertainties including digital error rate	0.4	0.4	Normal	2.00	1	0.20	0.20
12	Frequency Response	Included in the output level step resolution	0	0	Rectangular	1.73	1	0.00	0.00
Stage 1: Calibration measurement, network analyzer method									
13	Uncertainty of network analyzer	Manufacturer's uncertainty calculator, covers NA setup	0.2	0.5	Normal	2.00	1	0.10	0.25
14	Mismatch of transmitter chain	Taken into account in VNA setup uncertainty	0	0	U-shaped	1.41	1	0.00	0.00
15	Insertion loss of transmitter chain	Systematic with Stage 2 (=> cancels)	0	0	Rectangular	1.73	1	0.00	0.00
16	Mismatch in the connection of calibration antenna	Taken into account in VNA setup uncertainty	0	0	U-shaped	1.41	1	0.00	0.00
17	Influence of the calibration antenna feed cable	Gain calibration with dipole	0.3	0.3	Rectangular	1.73	1	0.17	0.17
18	Influence of the measurement antenna cable	Systematic with Stage 2 (=> cancels)	0	0	Rectangular	1.73	1	0.00	0.00
19	Uncertainty of the absolute gain/ radiation efficiency of the calibration antenna	Calibration report with traceability to a National Metrology Institute	0.58	0.58	Normal	2.00	1	0.29	0.29
20	Measurement distance	Dipole: phase centre is aligned with axis of rotation	0	0	Rectangular	1.73	1	0.00	0.00
21	Quality of quiet zone	Peak-to-null ripple	0.5	0.5	Rectangular	1.73	1	0.29	0.29
Combined Standard Uncertainty [dB]								1.05	1.09

Expanded Uncertainty [dB] (Confidence interval of 95 %)								2.06	2.13
22	Systematic Error related to TRS grids	mean error	0	0.00	Actual	1.00	1	0.00	0.00
Total Expanded Uncertainty [dB] (Confidence interval of 95 %)								2.06	2.13

Annex B (normative): Phantoms definition and Positioning

B.1 General

This Clause defines the phantom definition and positioning guidance for TPR TRS requirement measurement.

B.2 Phantom Definition

B.2.1 Head Phantom

The basic head phantom is based on the “SAM” head phantom in IEEE Std 1528-2003, which is also described in TS 37.544 Annex A.2 [15]. For TRP TRS test, the IEEE SAM head model has been extended to the neck region, which is specified in CTIA Certification OTA Test Plan [12].

The Head phantom defined in CTIA Certification OTA Test Plan [12], is used for FR1 TRP TRS requirement testing.

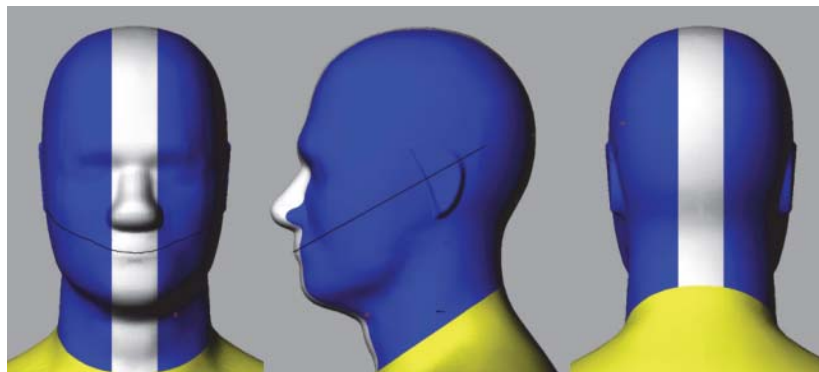

Figure B.2.1-1 Head Phantom (© 2001 – 2022 CTIA Certification. Reproduced with permission.), defined in the CTIA Certification OTA Test Plan

B.2.2 PDA Grip Hand Phantom

The PDA Grip Hand described in TS 37.544 Annex A.2.2 [15], which is identical to that defined in CTIA Certification OTA Test Plan 01.72 section 2.2.12 [12], is adopted for TRP TRS testing for the UE with width $\geq 56\text{mm}$ and $\leq 72\text{mm}$.

B.2.3 Wide Grip Hand Phantom

The Wide Grip hand defined in CTIA Certification OTA Test Plan 01.72 Section 2.2.13 [12], is used for FR1 TRP TRS testing for UE with width $>72\text{mm}$ and $\leq 92\text{mm}$.



Figure B.2.3-1 Wide Grip hand (© 2001 – 2022 CTIA Certification. Reproduced with permission.), defined in the CTIA Certification OTA Test Plan

B.2.4 Forearm Phantom

The Forearm phantom defined in CTIA Certification OTA Test Plan [12], is used for FR1 TRP TRS testing for wrist-worn RedCap UEs.

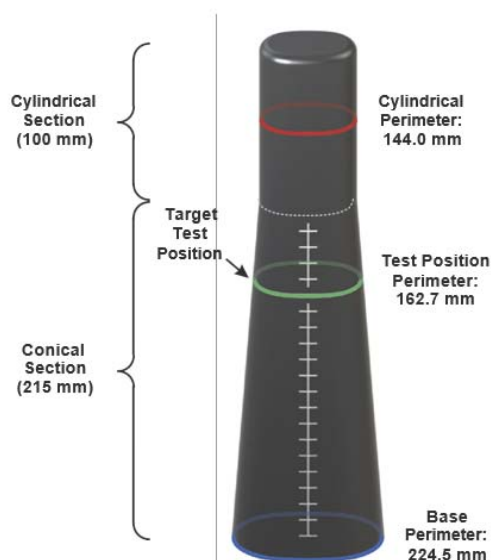

Figure B.2.4-1: Forearm Phantom with Target Test Position (© 2001 – 2022 CTIA Certification. Reproduced with permission.), defined in the CTIA Certification OTA Test Plan

B.3 UE positioning guidelines

B.3.1 Hand phantom only (Browsing mode)

The positioning specified in this clause is used for the test cases for Browsing Mode with Hand Phantom. The characteristics of the Hand Phantom are specified in Clause B.3.1. Browsing mode is used to simulate user cases where the DUT is held in hand, but not pressed against ear e.g. web browsing and navigation. The DUT should be set as primary mechanical mode for browsing mode scenario, which is declared by manufacturer if the UE support multiple

mechanical modes. Then, the DUT shall be mounted in a suitable hand phantom and oriented such that the DUT's main display is tilted 45 degrees from vertical:

- Wide Grip Hand for UE with Width $>72\text{mm}$ and $\leq 92\text{mm}$
- PDA Grip Hand for UE with Width $\geq 56\text{mm}$ and $\leq 72\text{mm}$

Note: the width is the UE width under primary mechanical mode for Browsing mode scenario.

B.3.1.1 Wide Grip Hand

This positioning guideline is suitable for DUTs with width $>72\text{mm}$ and $\leq 92\text{mm}$.

The positioning guideline for mounting a DUT in the Wide Grip Hand Phantom defined in CTIA Certification OTA Test Plan 01.71 Section 2.2.7 [9], is used for FR1 TRP TRS testing for UE with width $>72\text{mm}$ and $\leq 92\text{mm}$.

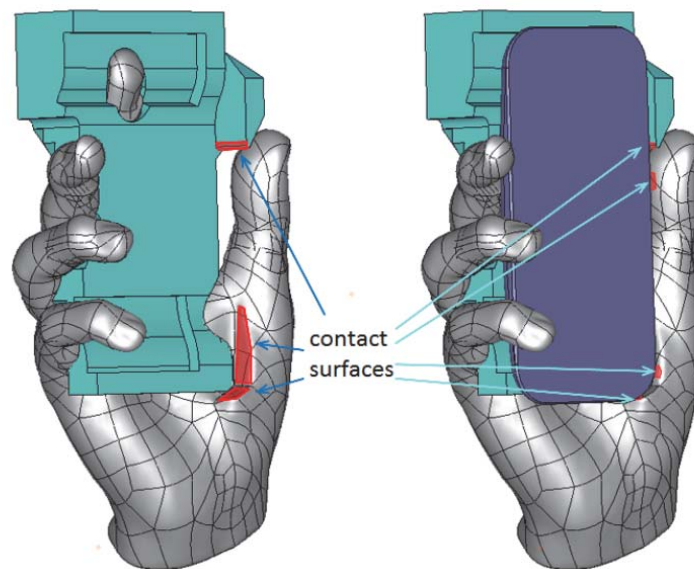

Figure B.3.1.1-1: Positioning guidance for Wide Grip Hand (© 2001 – 2022 CTIA Certification. Reproduced with permission.), defined in the CTIA Certification OTA Test Plan

B.3.1.2 PDA Grip Hand

This clause defines the positioning guideline for mounting a DUT in the PDA Grip Hand Phantom. This positioning guideline is suitable for DUTs with width $\geq 56\text{mm}$ and $\leq 72\text{mm}$.

To help achieve a consistent positioning, the DUT is aligned to a PDA palm spacer. No alignment tool is required. The PDA spacer features side and bottom walls to ensure consistent alignment of DUTs of various sizes.

1. Place the DUT on the PDA spacer between the fingers and align the DUT to the side wall of the PDA.
2. If the DUT is shorter than 135 mm, then align the top of the DUT with the top of the PDA spacer. Otherwise, align the bottom of the DUT with the bottom wall of the PDA spacer.



Figure B.3.1.2-1: Right-handed PDA Grip hand phantom with a spacer

NOTE: Use left-handed (mirror-imaged) spacers with left-handed phantoms.

B.3.2 Head and Hand phantom (Talk Mode)

B.3.2.1 General

Editor's note: Clarification required regarding statement on contact with the ear in Step 3

The positioning specified in this clause is used for the test cases for Talk Mode using Head & Hand Phantom. The characteristics of the Hand Phantom and Head Phantom are specified in Clause B.2.

Talk mode is used to simulate user cases where the DUT is placed into a hand phantom, which is holding the DUT against the SAM head phantom, presenting a realistic voice call operation of the DUT. The DUT should be set as primary mechanical mode for talk mode scenario, which is declared by manufacturer if the UE support multiple mechanical modes. Same as Browsing mode, the DUT for talk mode shall also be mounted in a suitable hand phantom:

- Wide Grip Hand for UE with Width $>72\text{mm}$ and $\leq 92\text{mm}$
- PDA Grip Hand for UE with Width $\geq 56\text{mm}$ and $\leq 72\text{mm}$

Note: the width is the UE width under primary mechanical mode for talk mode scenario.

In this section, the procedure provides the guideline on how to place the DUT+hand against the head phantom. The detailed DUT positioning into hand phantom for talk mode is defined in Clause B.3.1.

For talk mode, the DUT is attached to the head phantom in “cheek” position. The DUT performance is measured on both left and right side of the head. Three points as shown in Figure B.3.2.1-1 define the reference plane: centre of the right ear piece (RE), centre of the left ear piece (LE) and centre of mouth (M).

Definition of the ‘Cheek’ position:

1. Align the ear piece of the phone (see Figure B.3.2.1-1) at the line RE-LE. Then, position the DUT beside the phantom so that the vertical line (see Figure B.3.2.1-3) is parallel to the reference plane in Figure B.3.2.1-2 and is aligned with the line M-RE on the reference plane (see Figure B.3.2.1-3).
2. Position the DUT so that the ear piece of the DUT touches the ear piece of the phantom head on the line RE-LE. Tilt the DUT chassis towards the cheek of the phantom having the vertical line aligned with the reference plane until any point on the front side of the DUT is in contact with the cheek or until the contact with the ear is lost.

NOTE: A holder fixture made of e.g. plastic may be used to position the handset against the phantom.

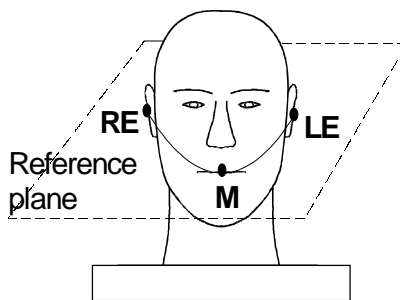

Figure B.3.2.1-1: Reference plane on head phantom, front view

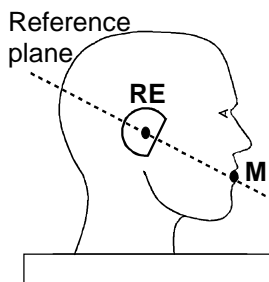

Figure B.3.2.1-2: Reference plane on head phantom, side view

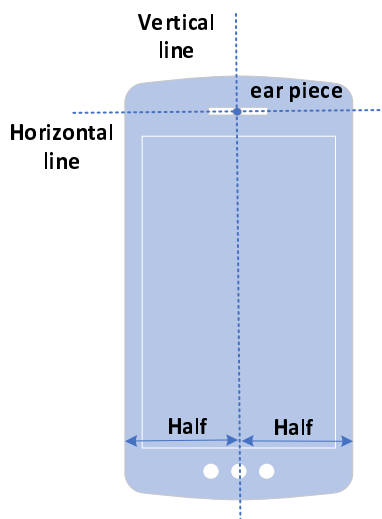

Figure B.3.2.1-3: Reference lines at a mobile handset

In addition, 6° tilt angle from the cheek is being used instead of having direct contact between the cheek and DUT. A mask may be used to help configuration of cheek + 6° tilt angle. The mask is a 32 mm wide conformal strip, created by sweeping the surface of the head phantom through a 6° rotation about the ear. Direct DUT contact against the mask thus establishes the required 6° spacing away from the cheek, regardless of DUT form factor. The material for the head phantom mask spacer shall have dielectric constant of less than 1.3 and a loss tangent of less than 0.003. Material additions can be used to help fixing of the mask spacer onto the head phantom.

In summary, for head + hand phantom, keeping the DUT in the hand phantom in the position defined in clause B.3.1, while place the DUT and the hand phantom against the head phantom in such way that the DUT is in 6° tilt angle as described above.

B.3.2.2 Wide Grip Hand and Head

This procedure is suitable for talk mode use with DUTs of width $>72\text{mm}$ and $\leq 92\text{mm}$. The positioning of the DUT in the Wide Grip hand for talk mode is identical to that for browsing mode described in Clause B.3.1.1.

B.3.2.1 PDA Grip Hand and Head

This procedure is suitable for talk mode use with DUTs of width $\geq 56\text{mm}$ and $\leq 72\text{mm}$. The positioning of the DUT in the PDA Grip hand for talk mode is identical to that for browsing mode described in Clause B.3.1.2.

B.3.3 Forearm phantom (Wrist-worn Mode)

B.3.2.1 General

The positioning specified in this clause is used for the test cases for Wrist-worn Mode using Forearm Phantom. The characteristics of the Forearm phantom is specified in Clause B.2.4.

Talk mode is used to simulate user cases where the DUT is placed in Forearm phantom. The DUT should be set as primary mechanical mode for browsing mode scenario, which is declared by manufacturer if the UE support multiple mechanical modes.

B.3.2.2 Forearm phantom positioning in the chamber

The Forearm Phantom shall be mounted in the chamber coordinate system as shown in Figure B.3.2.2-1.

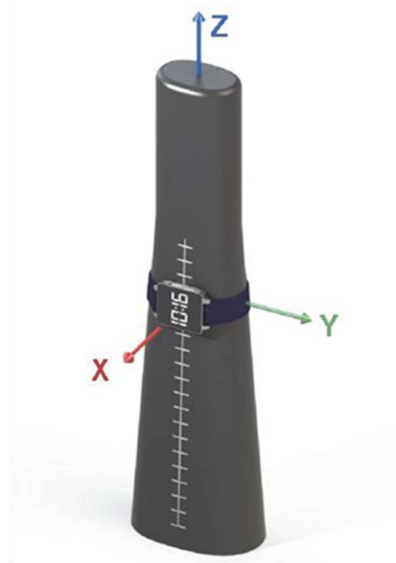

Figure B.3.2.2-1: Positioning guidance for Forearm Phantom in the chamber (© 2001 – 2022 CTIA Certification. Reproduced with permission.), defined in the CTIA Certification OTA Test Plan

B.3.2.3 Wrist-Worn RedCap Device mounted on the Forearm Phantom

This clause defines the positioning guideline for wrist-worn RedCap devices.

The positioning guideline defined in CTIA Certification OTA Test Plan 01.71, section 2.3 [9], is used for FR1 TRP TRS testing for wrist-worn RedCap devices in this technical specification.

The Wrist-worn Device should be fully aligned under some specific virtual Plane to make sure the Wrist-worn Device is properly mounted on the Forearm Phantom, as shown in B.3.2.3-1. Plane *J* cuts through the surface of the forearm phantom and passes through the target test position and is perpendicular to the Y-axis. Plane *J* is the X-Z plane. Plane *K*

cuts through the forearm phantom at the target test position and is perpendicular to the Z-axis. Plane *K* is the X-Y plane. Plane *A* and Plane *B* are virtual planes on wrist-worn device. Plane *A* cuts through the center of wrist band and Plane *B* cuts through the center of the display.

Plane *B* shall be fully aligned with Plane *J* when the device is mounted on the forearm phantom.

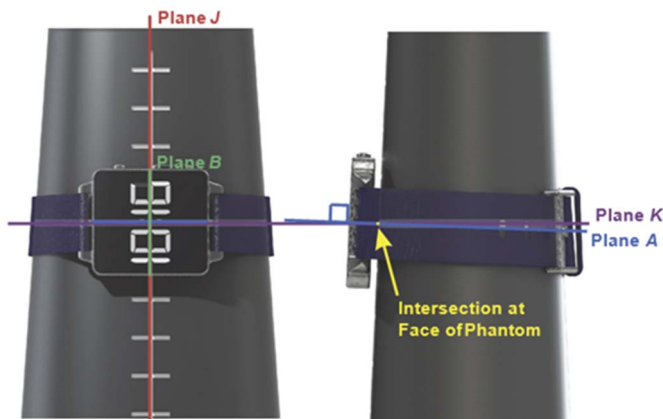

Figure B.3.2.3-1: Positioning guidance for Wrist-Worn Device mounted on the Forearm Phantom (© 2001 – 2022 CTIA Certification. Reproduced with permission.), defined in the CTIA Certification OTA Test Plan

DUTs shall be mounted with sufficiently snug band tightness so as to prevent the DUT from slipping off under the force of gravity when the phantom is inverted.

Similar to handheld UEs, there are also two Orientations for Wrist-worn RedCap Devices representing the Left and Right Wrist, as shown in Figure B.3.2.3-2.



Figure B.3.2.3-2: Left and Right positioning for Wrist-Worn Device on Forearm Phantom (© 2001 – 2022 CTIA Certification. Reproduced with permission.), defined in the CTIA Certification OTA Test Plan

Annex C (normative): Environmental requirements

C.1 General

This normative annex specifies the environmental requirements of the UE. Within these limits the requirements of the present documents shall be fulfilled.

C.2 Environmental

The requirements in this clause apply to all types of UE(s).

C.2.1 Temperature

All the test cases defined in this technical specification should be measured in room temperature e.g. 25°C.

C.2.2 Voltage

All test cases shall be performed in the normal voltage condition with the DUT operated in stand-alone battery powered mode. No extreme voltage testing is required. It is recommended to start the testing with a fully charged battery and conclude and/or pause testing before the battery has completely lost its charge.

Annex D (normative): Maximum uncertainty of test system and test tolerance

D.1 Maximum uncertainty of test system

The maximum acceptable uncertainty of the Test System is specified in Table D.1-1 for each test, where appropriate. The Test System shall enable each test to be measured with an uncertainty not exceeding the specified values. All ranges and uncertainties are absolute values and are valid for a confidence level of 95 %.

In Annex A.4, the estimation of measurement uncertainty is defined.

Table D.1-1: Maximum Test System uncertainties for TRP hand only (browsing mode) tests using anechoic chamber method for NR FR1 bands

Clause	Maximum Test System Uncertainty (MTSU)	Derivation of Test System Uncertainty
6.2.1.1.1 Total Radiated Power (TRP) for FR1 NR Standalone (SA) in Browsing Mode with Hand Phantom	1.64 dB : < 3 GHz	Refer to Annex A.4
	1.73 dB >= 3 GHz	
7.2.1.1.1 Total Radiated Sensitivity (TRS) for FR1 NR Standalone (SA) in Browsing Mode with Hand Phantom	2.06 dB : < 3 GHz	Refer to Annex A.4
	2.13 dB >= 3 GHz	

D.2 Test Tolerances

Test tolerances in Table D.2-1 are used to relax the Minimum Requirements in the present document and to derive the Test Requirements.

Table D.2-1: Test Tolerances for TRP hand only (browsing mode) tests using anechoic chamber method for NR FR1 bands

Clause	Test Tolerance (TT)
6.2.1.1.1 Total Radiated Power (TRP) for FR1 NR Standalone (SA) in Browsing Mode with Hand Phantom	TT = 0.62 x MTSU
	1.02 dB : < 3 GHz 1.07 dB >= 3 GHz
7.2.1.1.1 Total Radiated Sensitivity (TRS) for FR1 NR Standalone (SA) in Browsing Mode with Hand Phantom	TT = 0.62 x MTSU
	1.28 dB : < 3 GHz 1.32 dB >= 3 GHz

Annex E (informative): Change History

Change history							
Date	Meeting	TDoc	CR	Rev	Cat	Subject/Comment	New version
2022-09	RAN5#96e	R5-225241	-	-	-	Initial Skeleton	0.0.1
2022-12	RAN5#97	R5-227385	-	-	-	Update to v0.1.0 to incorporate approved pCRs	0.1.0
2022-12	RAN5#97	R5-227356	-	-	-	pCR for Addition of Hand only phantom definitions	0.1.0
2022-12	RAN5#97	R5-227357	-	-	-	pCR for Addition of UE positioning guidelines	0.1.0
2022-12	RAN5#97	R5-227883	-	-	-	pCR for Addition of minimum requirement definition	0.1.0
2022-12	RAN5#97	R5-227359	-	-	-	pCR for Annex updates to introduce NR FR1 TRP TRS UE configuration details	0.1.0
2022-12	RAN5#97	R5-227360	-	-	-	pCR for Annex updates to introduce NR FR1 TRP TRS test system details	0.1.0
2022-12	RAN5#97	R5-227365	-	-	-	pCR for Addition of applicability rules for SA and NSA devices in clause 4	0.1.0
2022-12	RAN5#97	R5-227366	-	-	-	pCR for General updates in clause 3	0.1.0
2022-12	RAN5#97	R5-227367	-	-	-	pCR for Addition of frequency band info in Clause 5	0.1.0
2022-12	RAN5#97	-	-	-	-	Small editorial corrections	0.1.0
2023-03	RAN5#98	R5-231315	-	-	-	TP to TS 38.561 on MU contents	0.2.0
2023-03	RAN5#98	R5-231357	-	-	-	Additional of test parameters for FR1 TRP TRS testing	0.2.0
2023-03	RAN5#98	R5-231802	-	-	-	Introduction of SA FR1 Browsing Mode TRP TC 6.2.1.1.1	0.2.0
2023-03	RAN5#98	R5-231801	-	-	-	Introduction of SA FR1 Browsing Mode TRS TC 7.2.1.1.1	0.2.0
2023-03	RAN5#98	R5-231360	-	-	-	Addition of Annex with Environmental Requirements for FR1 TRP TRS tests	0.2.0
2023-03	RAN5#98	R5-231361	-	-	-	Updates to Section 3 of FR1 TRP TRS test spec	0.2.0
2023-03	RAN5#98	R5-231362	-	-	-	Updates to sub-clause 5.2.2 of FR1 TRP TRS test spec	0.2.0
2023-06	RAN5#99	R5-233677	-	-	-	MU values for NR FR1 TRP-TRS	0.3.0
2023-06	RAN5#99	R5-233709	-	-	-	Correction of TRS minimum requirement	0.3.0
2023-06	RAN5#99	R5-233040	-	-	-	Update to TRP and TRS test applicability	0.3.0
2023-06	RAN5#99	R5-233242	-	-	-	Clarification of test parameters for FR1 TRP TRS testing	0.3.0
2023-06	RAN5#99	R5-233243	-	-	-	Introduction of SA FR1 Talk Mode TRP TC 6.2.1.2.1	0.3.0
2023-06	RAN5#99	R5-233244	-	-	-	Introduction of SA FR1 Talk Mode TRS TC 7.2.1.2.1	0.3.0
2023-06	RAN5#99	R5-233245	-	-	-	Update of SA FR1 Browsing Mode TRP TC 6.2.1.1.1	0.3.0
2023-06	RAN5#99	R5-233246	-	-	-	Update of SA FR1 Browsing Mode TRS TC 7.2.1.1.1	0.3.0
2023-09	RAN5#100	R5-235940	-	-	-	pCR with TRP/TRS MU Updates	1.0.0
2023-09	RAN5#100	R5-235210	-	-	-	Clarification on EN-DC decision tree	1.0.0
2023-09	RAN5#100	R5-235796	-	-	-	Update of SA FR1 Browsing Mode TRP and TRS tests	1.0.0
2023-09	RAN5#100	R5-235212	-	-	-	Correction to Annex Structure	1.0.0
2023-12	RAN5#101	R5-237947	-	-	-	pCR with TRP/TRS MU Updates	1.1.0
2023-12	RAN5#101	R5-237840	-	-	-	Update of SA FR1 Browsing Mode TRP TC	1.1.0
2023-12	RAN5#101	R5-237854	-	-	-	Update of SA FR1 Browsing Mode TRS TC	1.1.0
2023-12	RAN5#101	R5-237855	-	-	-	Editorial corrections across the FR1 TRP TRS test spec	1.1.0
2023-12	RAN#102	RP-233549	-	-	-	presented at RAN#102 for approval	2.0.0
2023-12	RAN#102	-	-	-	-	put under revision control as v17.0.0 with small editorial changes	17.0.0
2024-03	RAN#103	R5-241929	0002	1	F	CR on EIS search interpolation	17.1.0
2024-03	RAN#103	R5-241931	0004	1	F	Update of TT within TRP and TRS tests	17.1.0
2024-03	RAN#103	R5-241932	0003	1	F	Updates across TS 38.561 V17.0.0	17.1.0
2024-03	RAN#103	R5-241931	0004	1	F	added missing change of Table 7.2.1.1.1.5-3->2	17.1.1
2024-06	RAN#104	R5-243408	0010	-	F	Editorial updates within TRP tests	17.2.0
2024-06	RAN#104	R5-243409	0011	-	F	Editorial updates within TRS tests	17.2.0
2024-06	RAN#104	R5-243797	0006	1	F	Clarification of Calibration and Ripple Test Procedures	17.2.0
2024-06	RAN#104	R5-243798	0007	1	F	Clarification of polynomial interpolation	17.2.0
2024-06	RAN#104	R5-243799	0009	1	F	Updates across TS 38.561 V17.0.0	17.2.0
2024-09	RAN#105	R5-245744	0012	1	F	Clarification of voltage environmental requirement	17.3.0
2024-09	RAN#105	R5-246004	0013	1	F	Updates to Annex D for MU and TT	17.3.0
2024-09	RAN#105	R5-245448	0014	-	F	Updates to Annex A related to test system methods	18.0.0
2024-09	RAN#105	R5-246003	0015	1	F	Updates to Annex B related to phantom definitions	18.0.0
2024-12	RAN#106	R5-247494	0017	-	F	Updates to common clauses in FR1 TRP TRS test specification	18.1.0
2024-12	RAN#106	R5-247964	0016	1	F	Updates to Annexes in FR1 TRP TRS test specification	18.1.0
2024-12	RAN#106	R5-247965	0018	1	F	Updates to Talk Mode FR1 TRP and TRS test cases	18.1.0
2024-12	RAN#106	R5-247966	0019	1	F	Updates to Browsing Mode FR1 TRP and TRS test cases	18.1.0

History

Document history		
V18.0.0	October 2024	Publication
V18.1.0	January 2025	Publication